

sonitron Piezo Audio Speakers & Amplifiers are the perfect answer for audio sound, voice messages and complex audio information into portable devices.

When there is no place"a piezo speaker feels comfortable". "Perfect fit" and "slim line" are the words you can add to your design.

No more worries anymore about water drops that can damage the front of your speaker. The piezoelectric speakers of Sonitron embrace these problems and nevertheless EMC/EMI is history.



Patented multilayer Technology

A few years ago piezoelectric speakers were only known as piezo tweeters. Loudspeakers that are able to produce only high audio frequencies, typically from around 2 kHz to 20 kHz.

Sonitron, established in 1977 and European leader in piezoelectric audio components, started with intensive research to develop broadband audio speakers who have a frequency response graph beneath 1kHz.

Sonitron developed and patented a completely new principle of piezoceramics and a composite polymer/metal membrane. The composite polymer/metal membrane reduces unwanted resonance peaks to provide a more even frequency response than can be achieved with conventional designs. High sound quality and low distortion guarantee perfect reproduction of music and speech.

" Polymer/ metal membrane"

The Basic Four of Piezoelectric Audio Speakers

Piezoelectric speakers have a total different working principle than an electro dynamic speaker. There is no coil, no magnetic field and no large current consumption.

"No electro-magnetic field (EMC/EMI)"

The heart of each piezoelectric speaker is a ceramic disc that interacts when it feels a certain voltage difference.

An increase of the signal amplitude Vpp (Voltage peak to peak), will result in a larger piezo deformation and result in a larger sound output.

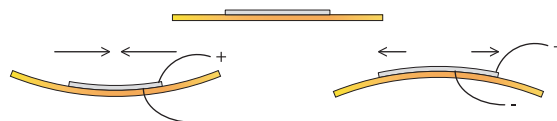

"Interacting with voltage variations"
"More Vpp creates more sound output"

Piezoelectric speakers have a complex electronic equivalent circuit but mainly they can be seen as a capacitive load with values between 10nF and 1µF.

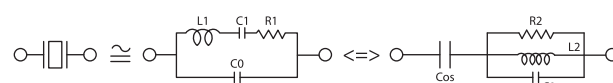

The capacitive value of the speaker is an important characteristic for the amplifier circuit of the speaker.

"Piezoelectric means capacitive load"

Most amplifier IC's are developed for electrodynamic speakers. They can deliver high current variations and are limited to a voltage level of +/- 10 Vpp.

Piezoceramic speakers demand voltage variations. The current consumption is extreme small and the voltage peak to peak level goes up to 60Vpp.

"Piezo Audio Amplifier is needed"

Capacitive load

Because piezoelectric speakers mainly act as a capacitive load, the complex impedance will decrease with an increase of the frequency. The capacitive reactance is an asymptotic function.

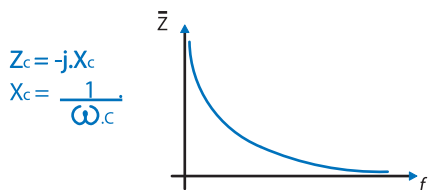

Amplifier configurations

The construction of a Piezo Audio Amplifier (PAA) consists of two basic electronic concepts.

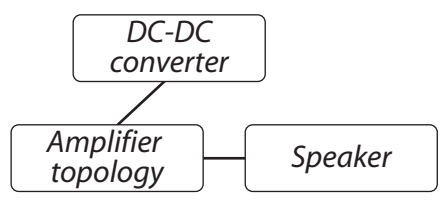

A DC-DC converter brings a lower voltage to a higher level and creates the maximum voltage level for the end amplifier.

The end amplifier can be made out of different amplifier topologies. Class AB, class D, Class G,...

The combination and efficiency of the used DC-DC converter and amplifier topology will determine the main power consumption

To avoid high voltage levels the Bridge-Tied Load configuration is commonly used. An audio signal of 60 volt peak-to-peak (Vpp) can be created with a DC voltage of 30V.

Creating a voltage level of 30Vdc instead of 60Vdc is easier done with a DC-DC converter. The piezoelectric speaker is between two amplifiers. The left side will see a 30Vpp signal while on the right the same signal of 30Vpp will appear reversed (180° phase shifted). With this technique the piezo speaker will see a total audio signal of 60Vpp. e.g. [PAA-StepUpBTL-01](#)

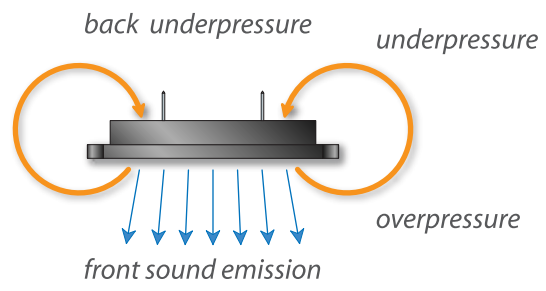

Fundamental acoustic mountings

Piezoceramic speakers produce sound by the forward and backward movement of a flat membrane.

During this movement the membrane creates an air pressure wave in front and at the backside of the membrane.

A forward movement will create a slight overpressure at the frontside and a slight underpressure at the backside and vice versa. It is therefore important that the front and backside are acoustically isolated from each other to avoid air pressure cancellation and consequently a serious reduction of the sound output.

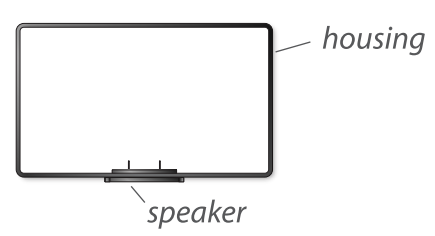

When a speaker is mounted in a panel or in the wall of a housing, the front side is acoustically isolated from the backside.

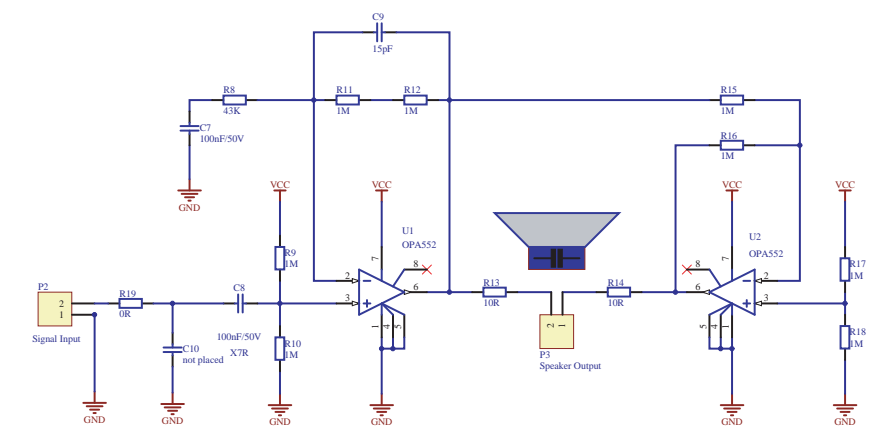
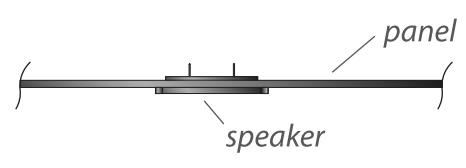

Piezoelectric Speaker Terminology

Piezo, derived from the Greek piezein, which means to squeeze or press

Piezoelectricity, is the charge which accumulates in certain solid materials (notably crystals, certain ceramics) in response to applied mechanical stress. The word piezoelectricity means electricity resulting from pressure.

Piezoceramic, is a ceramic disc with piezo characteristics. The disc will expand when a certain voltage level is applied.

Piezoelectric audio speaker, is a broadband loudspeaker made out of piezo material. Start frequency from 200Hz up to 20kHz.

SPL, Sound Pressure Level refers to a certain dB level at a certain distance.

dB, Decibel is a logarithmic unit that indicates the ratio of a physical quantity (usually power or intensity) relative to a specified or implied reference level.

A change in power ratio by a factor of 10 is a 10 dB change. A change in power ratio by a factor two is approximately a 3dB change.

Vpp, Voltage peak to peak is the voltage difference between the maximum and minimum voltage level of a signal.

PAA: Piezo Audio Amplifier is a single integrated circuit, or a PCB developed to amplify small audio signals, that drives piezoelectric audio loudspeaker elements.

Pink Noise:

1/f noise is a signal with a frequency spectrum such that the power spectral density is inversely proportional to the frequency. In pink noise, each octave carries an equal amount of noise power. There is equal energy in all octaves (or similar log bundles)

Power consumption

The average power consumption of piezoelectric speakers can be calculated by multiplying the RMS-voltage and RMS-current.

The RMS-voltage (V_{rms}) is defined by the input signal. The used signal is a standard pink noise signal with a value of 10,6 / 21,21 V_{rms} . The signal has the same energy as a sine wave of 30 / 60Vpp

The RMS-current (I_{rms}) is measured with a true rms multimeter (Fluke 87IV) in series with the speaker. A piezoelectric speaker can mainly be seen as a capacitive load and therefore there will be no DC current consumption. The only current consumption will be of the AC-current component

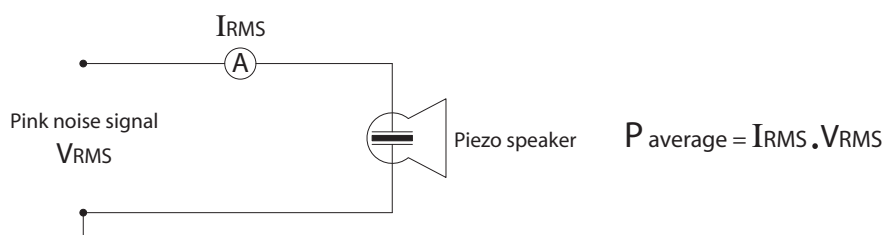

Values Blue Line SPS series speakers:

Model	10.6 V_{RMS} (30 Vpp sine) $I_{RMS}=mA$	21.21 V_{RMS} (60 Vpp sine) $I_{RMS}=mA$
SPS-29-T00	0,25Watt (= 24mA.10,6V)	1,00 Watt (= 47mA.21,21V)
SPS-41-T00	0,48 Watt (= 45mA.10,6V)	1,87 Watt (= 88mA.21,21V)
SPS-53-T00	0,78 Watt (= 74mA.10,6V)	3,05 Watt (= 144mA.21,21V)
SPS-68-T00	1,38Watt (= 130mA.10,6V)	5,51 Watt (= 260mA.21,21V)

Values SPS series speakers:

Model	10.6 V_{RMS} (30 Vpp sine) $I_{RMS}=mA$	21.21 V_{RMS} (60 Vpp sine) $I_{RMS}=mA$
SPS-3530-03	0,25 Watt (= 24mA.10,6V)	1,06 Watt (= 50mA.21,21V)
SPS-4640-03	0,27 Watt (= 25mA.10,6V)	1,06 Watt (= 50mA.21,21V)
SPS-6555-03	0,46 Watt (= 43mA.10,6V)	1,85 Watt (= 87mA.21,21V)
SPS-8770-03	0,76 Watt (= 72mA.10,6V)	2,86 Watt (= 135mA.21,21V)

Piezoelectric audio speakers will have more power consumption in the lower frequencies than electromagnetic speakers but have less power consumption in the higher frequencies.

The main power consumption will not come from the piezoelectric speaker but from the amplifier that is driving the speaker. The total concept has to be seen. How more efficient the Piezo audio amplifier is in combination with the piezoelectric speaker, how less the power consumption will be.

Piezo Audio Amplifier IC's

With the benefits of piezoelectric speakers:

- very flat
- small dimensions
- low weight
-

A lot of big electronic component companies have added specific amplifier IC's for piezoceramic speakers to their product range.



=> MAX9788

=> MAX9738



=> TPA2100P1



=> LM4960

=> LM4961

=> LM4962



=> LT3469



=> SN4915



=> AK7846

=> AK7845

Waterproof Speaker

The piezoelectric speakers from Sonitron can be used in an application with an IP rating of 65 to 66.

To have the best sound output a grid pattern can be made in the house of your application. A fine grid pattern is recommended.

The piezoelectric speaker has to be fixed with silicone glue above the pattern holes.

In this way the sound can go into the air true the grid pattern. The acoustic waves created by the front and the back side of the speaker are separate from each other. Which is one of the basic rules.

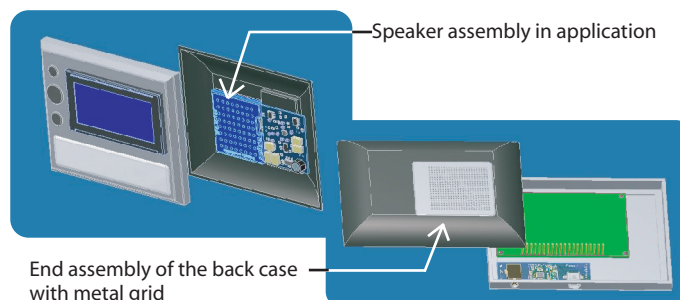

Frequency Response graph

The amplification graph of a speaker is shown in a logarithmic scale.

A theoretical ideal response graph for a speaker would be a flat line that covers the complete human audio frequency range from 20Hz to 20kHz.

A pink noise, which has equal energy in all octave bands, results in such a flat line on a logarithmic scale. It reflects the working of our human ear.

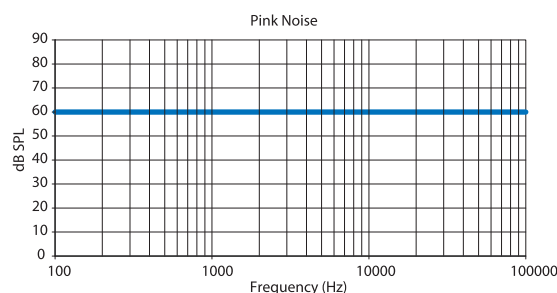

When a pink noise with a certain V_{rms} is sent to a speaker and the produced sound of the speaker is recorded with a microphone, the amplification response of the speaker can be shown.

The frequency response graph gives you an idea about the quality of the speaker. The total SPL gives you an idea about the complete loudness you can expect with a certain signal on a certain distance.

The piezoelectric audio speakers of Sonitron have a start frequency less than 1kHz even up to 200Hz, which gives an excellent result for multimedia applications.

From crystals to sound

"Advanced Technology with smart materials such as piezoceramic offer many new applications in audible components and devices. This new technology is a continuous development work that will bring you to the forefront in this world"

Hugo Michiels
President & CEO Sonitron nv



Blue Line SPS series

The Blue Line SPS piezoelectric audio speakers are designed for a broad range of applications. Equipped with a high power adhesive tape and soldering connection pads, the speaker is ready for easy mounting and fast production in every application.

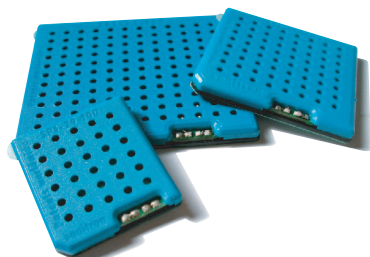

These series are reproducing sound signals at very low distortion (below 1%) and broad frequency range. The casing is designed to avoid sound wave reflection in the air outlet. The power consumption and current drain are extremely low over the entire frequency response range.

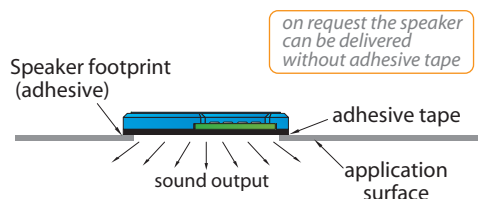

on request the speaker can be delivered without adhesive tape

Models:

Outline dimensions

- SPS-29 => 29 mm X 32mm
- SPS-41 => 41 mm X 43,5mm
- SPS-53 => 53 mm X 61,2mm
- SPS-68 => 68 mm X 83.5mm

Specifications:

Model	SPS-29-T00	SPS-41-T00	SPS-53-T00	SPS-68-T00
Frequency Range :	1KHz - 20 kHz	450Hz - 20 kHz	300Hz - 20 kHz	200Hz - 20 kHz
Max SPL @ 10 cm, 60 Vpp:	86 dB	90 dB	93 dB	97 dB
Distortion (%THD):	≤1%	≤1%	≤1%	≤1%
Capacitance (+/- 20%):	480 nF	880 nF	960 nF	1160 nF
Max. voltage PP, sine wave/RMS:	60Vpp/21.21 (VRMS)	60Vpp/21.21 (VRMS)	60Vpp/21.21 (VRMS)	60Vpp/21.21 (VRMS)
Weight:	3.1g	5.7g	10.1g	14.3g
Operating Temperature:	-20°C to 60°C	-20°C to 60°C	-20°C to 60°C	-20°C to 60°C
Storage Temperature:	-40°C to 60°C	-40°C to 60°C	-40°C to 60°C	-40°C to 60°C
Case material:	PC	PC	PC	PC

Frequency response graph with total SPL

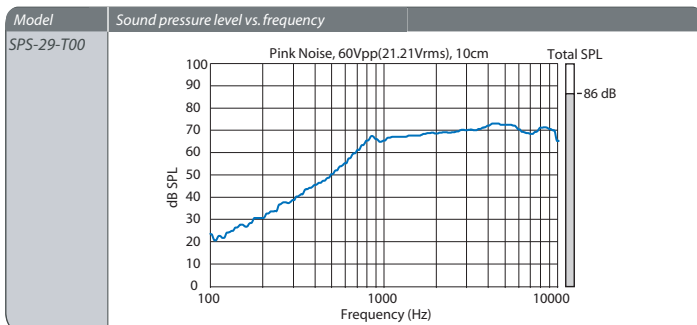
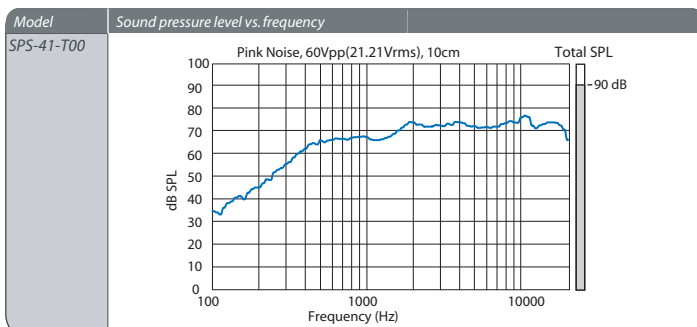
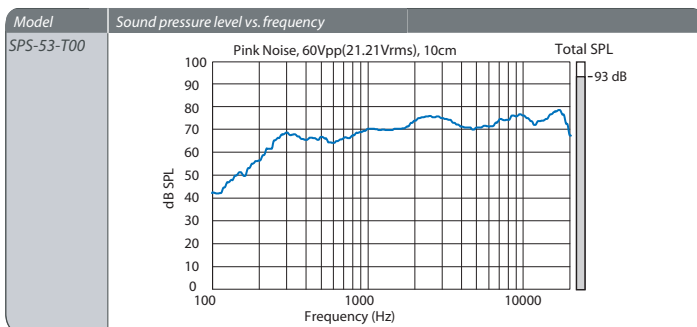
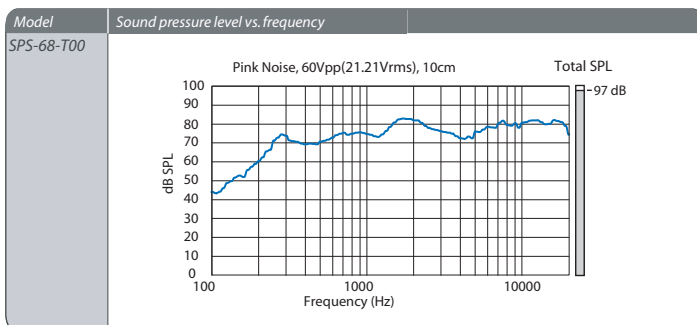

- Distance 10cm
- Pink noise signal 60Vpp (21,21Vrms)

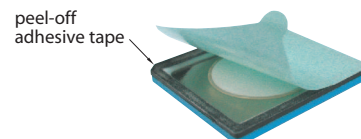

SPS series

Sonitron's SPS speakers have a very flat design and are delivered with an open front. They can be used in difficult environmental conditions and



applications since the front is resistant to water, humidity, vibrations and dust.

The described models are developed for applications such as mobile phone, PDA, flat LCD computer screens and computer monitors, consumer products, car audio, instrumentation, portable devices, public address systems, paging systems, etc.

Models:

- SPS-2220-03 ⇒ This model is only for earphone applications!
- SPS-3530-03
- SPS-4640-03
- SPS-6555-03
- SPS-8770-03

Specifications:

Model	Operating voltage (Vac pp)	Frequency range (Hz)	Max. SPL dB @ 1m, average 4 points	Applications	Capacitive load	Dimensions mm (LxWxH)
SPS-2220-03	1-24	700-20000	85*	Earphones	70nF	22x20x2
SPS-3530-03	5-60	700-20000	81	PDA, GPS, notebooks,...	220nF	43.5x39x2
SPS-4640-03	5-60	400-20000	83	PDA, GPS, notebooks,...	225nF	50x43.6x2
SPS-6555-03	5-60	300-20000	83	Multimedia,...	480nF	65x55x2
SPS-8770-03	5-60	200-20000	84	Computers,...	580nF	87x70x2

Best mounting method:

Mounted with glue or silicone

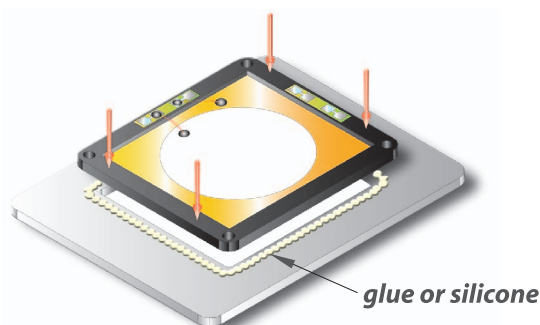

Frequency response graph with total SPL

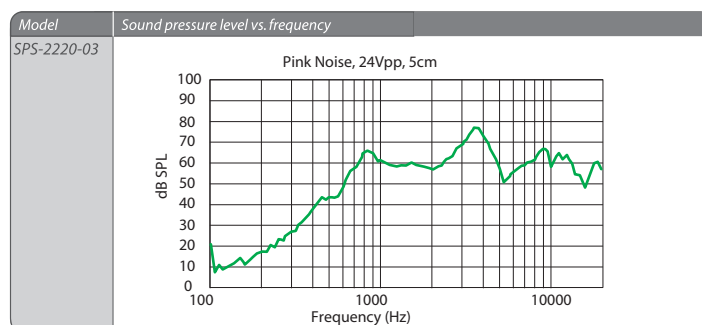
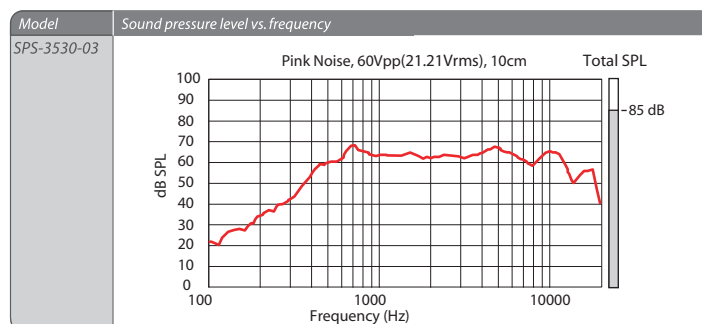
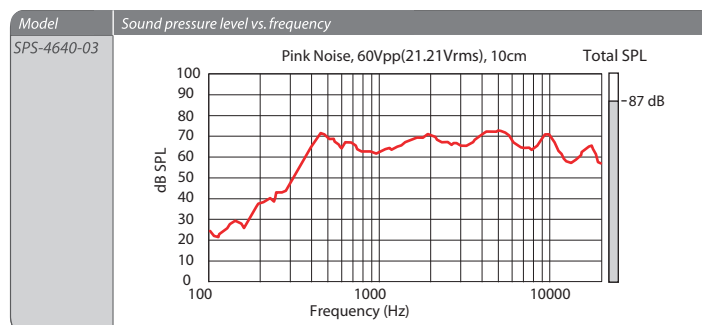
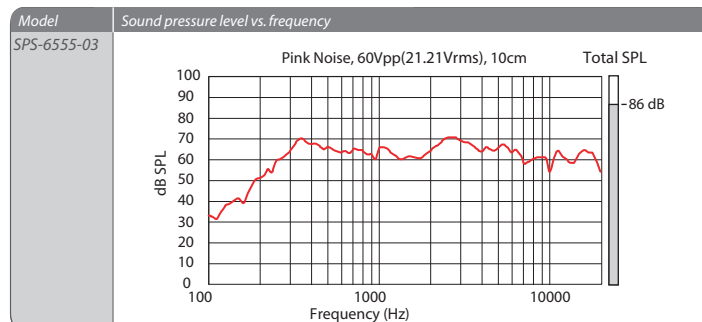
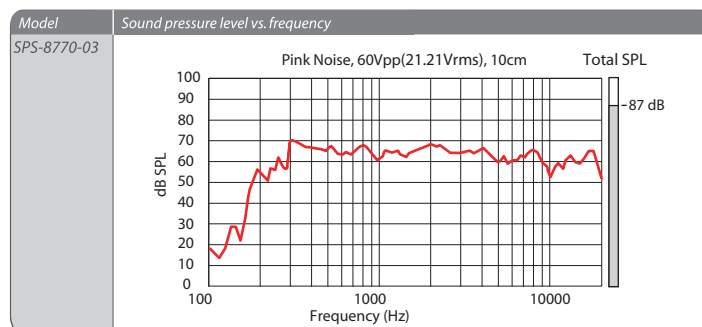

- Distance 10cm
- Pink noise signal 60Vpp (21,21Vrms)

Piezo Audio Amplifiers

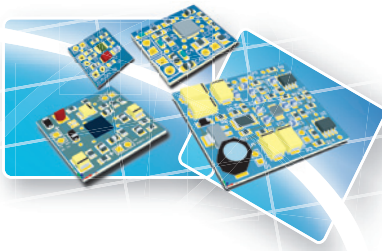

The Piezo Audio Amplifier PCB's of Sonitron are a total solution to drive piezoelectric sound components. A range of different PCB sizes, amplifier topologies and maximum voltage peak to peak outputs, cover a wide solution to piezo audio amplification.

Piezo Audio Amplifiers are designed to handle capacitive loads and have the possibility to deliver large voltages peak to peak over the complete audio frequency range

The PAA series gives a quality amplifier solution where a quality sound is needed.

- PAA-LT3469-01
- PAA-MAX9788-01
- PAA-LM4960SQ-02
- PAA-StepUpBTL-01

PAA-LT3469-01

A PCB of only 2.25cm². The LT3469 is a very small signal amplifier up to 30Vpp.

- Integrated charge pump power supply
- Class A Amplifier
- Single ended
- Capacitive load up to 250nF
- 10 components

total thickness:
2.7 mm

15x15 mm

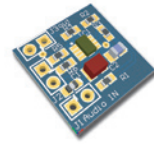

Fixed amplification ratio: +/- 131
Voltage input: 5 V

PAA-MAX9788-01

Designed on a printed circuits board of only 2,31 cm², the "Max9788" piezo audio amplifier of Maxim fulfils the needs of very small designs in portable applications. A maximum output of 20Vpp and very low power consumption makes it even more attractive.

- Integrated charge pump power supply
- Class G Amplifier
- Fully differential inputs and outputs
- Capacitive load up to 1µF
- 15 components

total thickness:
1.88 mm

14x16.5 mm

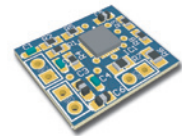

Fixed amplification ratio: +/- 80
Voltage input: 5 V

PAA-LM4960SQ-02

A perfect balance of a bridge tied load and step up converter on a small PCB, the "LM4960" IC of National Semiconductor reaches 24 Vpp for a load of 600nF. Small design and great sound output makes it very understandable.

- Integrated Step Up Converter
- Bridge tied load
- Very small inductor
- Up to 24Vpp
- 22 components

total thickness:
4.25 mm

25 x 25 mm

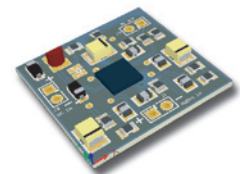

Fixed amplification ratio: +/- 74
Voltage input: 5 V

PAA-StepUpBTL-01

To go loud is to amplify the input signal to a large Voltage peak to peak swing of maximum 60Vpp. Tuned on the SPS piezo speakers the "StepUpBTL" piezo audio amplifier is designed for a very loud audio sound in a room. The creation of a 60Vpp swing derives from a stable DC power source of 30 V DC.

The boostconverter circuit is designed to a minimum surface with a maximum variety at the input source. A variation of the input voltage between 5V and 25V gives at the end a stable 30VDC to power the opamps with efficient power consumption. The amplifier circuit is a perfect balance between power consumption and space design. The Bridge Tied Load amplifier topology makes it possible to swing the signal to 60Vpp.

- Input voltage 5V-25V
- Max. output 60Vpp
- Two electronic circuits
- **Ideal: +input: 9Vdc
+output: 40Vpp**

Boost converter + Amplifier

- DC-DC- converter: Max 669 => output: 30 Vdc
- Amplifier circuit: OPA 551 => "Bridge tied load configuration"

total thickness:
6 mm

40 x 35 mm

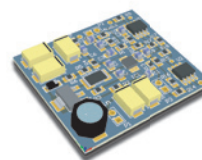

Fixed amplification ratio: +/- 90
Voltage input: 5-25 V

Model	PAA-LT3469-01	PAA-MAX9788-01	PAA-LM4960-02	PAA-StepUpBTL-01
Measurements PCB(mm)	15x15mm	14x16.5mm	25x25mm	40x35mm
Voltage input (V)	5V	5V	5V	5V-25V
MAX Capacitance Piezo Speaker	200nF	1µF	600nF	1µF
Max Voltage Output Vpp	33Vpp	20Vpp	24Vpp	60Vpp
Voltage Topology	Integrated step Up converter	Integrated step up converter	Integrated step up converter	Step up converter
Amplifier classification	Class A	Class G	Class AB	Class AB
Used amplifier configuration	Single ended	Fully Differential	Bridge Tied Load	Bridge Tied Load
Average current consumption of speaker and amplifier (mA)	45mA	15mA	85mA	40mA-400mA (2 Watt)

sonitron[®] Piezo Speakers & Piezo Audio Amplifiers

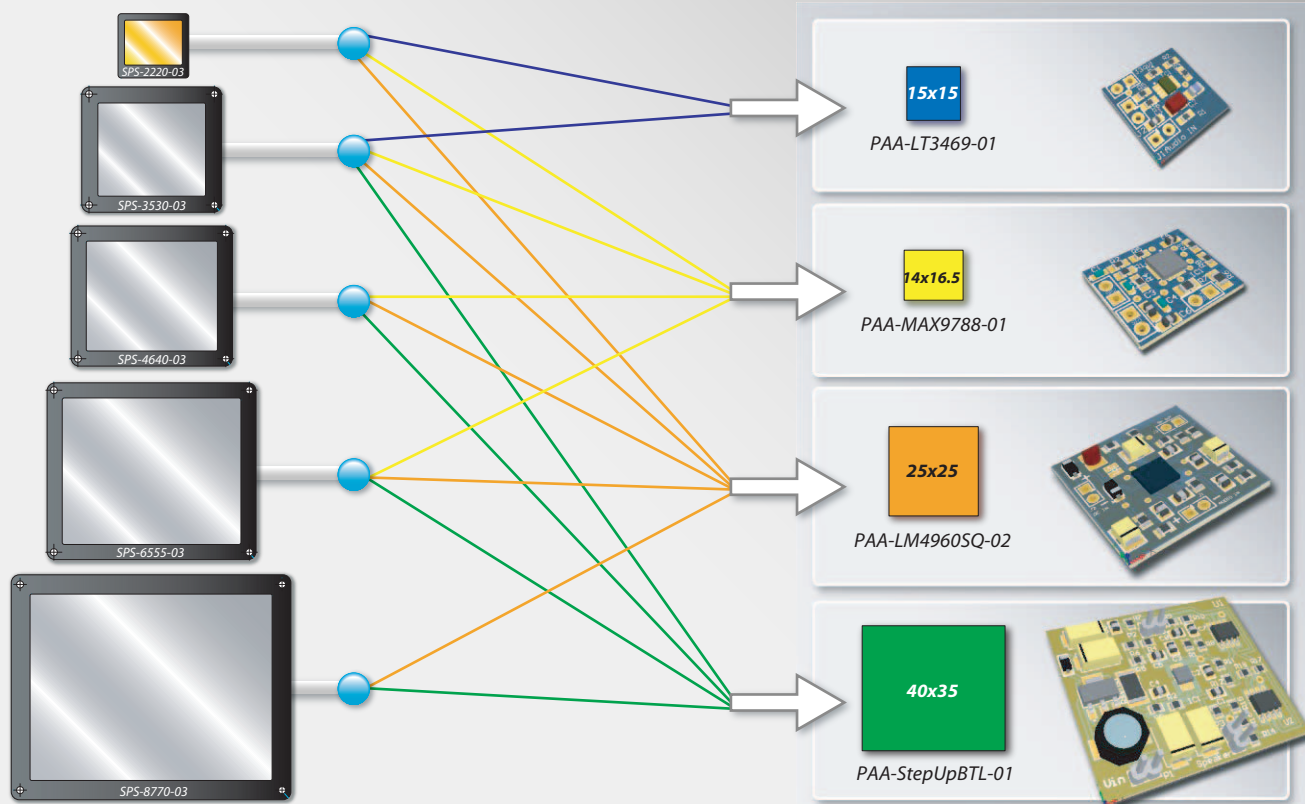

sonitron[®]

Piezo audio components

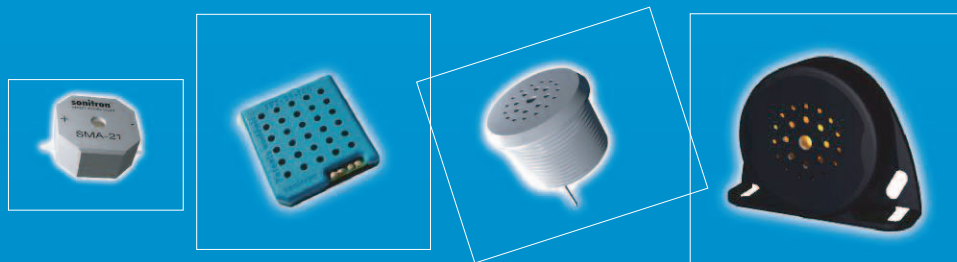

Buzzers Transducers Alarms
Sirens Piezo Speakers Amplifiers