



# OMNETICS

CONNECTOR CORPORATION

# MICRO-D CATALOG



**Omnetics Connector Corporation** is a leading global provider of precision and high-reliability electronic connectors and interconnect systems.

For more than 30 years, we have engineered an extensive portfolio of innovative products, with a special focus on micro-miniature and nano-miniature interconnects. Our connectors are among the smallest on the market and deliver exceptional performance in challenging work environments. As interconnect technologies continue to evolve, we design next-generation products that help bring transformative ideas to life.

Our connectors are highly sought after by designers working in the medical, military, aviation, aerospace, and other leading-edge industries. Omnetics understands the rigorous operating conditions mission-critical applications endure and our solutions include EMI shielding, IP sealing, polarization, rugged materials, and other elements that ensure connectivity under pressure. We maintain a large inventory of off-the-shelf products.

**Our high-reliability portfolio includes:**

- Micro and nano strip connectors*
- Micro and nano circular connectors*
- Nano-D / Bi-Lobe®*
- Polarized nano connectors*
- Squeeze-latching nano connectors*
- MIL-DTL-32139 Nano-D connectors*
- MIL-DTL-83513 Micro-D connectors*
- Micro-D and latching Micro-D connectors*
- Hybrid connector configurations*
- Cable assemblies*

**We take great pride in the products we build for you.** Our design team works closely with customers to create new and custom interconnect solutions for tomorrow's innovative products. Our connectors are designed, produced, and tested by hand at our plant in the United States. Omnetics is a privately held company and we exist to advance innovation wherever it is needed next.



# INDEX

<b>SPECIFICATIONS</b>	<b>2</b>
<b>MIL-DTL-83513 / MICRO-D</b>	<b>8</b>
<b>METAL SHELL STANDARD</b>	<b>12</b>
<b>LOW PROFILE</b>	<b>52</b>
<b>SINGLE ROW</b>	<b>80</b>
<b>LATCHING</b>	<b>100</b>
<b>SINGLE ROW LATCHING</b>	<b>132</b>
<b>JUMPERS</b>	<b>152</b>
<b>MICRO-D HYBRID ARRANGMENTS</b>	<b>156</b>
<b>BOARD MOUNT LAYOUTS</b>	<b>158</b>
<b>CONNECTOR SAVERS</b>	<b>164</b>
<b>HARDWARE &amp; MISC</b>	<b>168</b>

## THE FLEX PIN

Omnetics' groundbreaking Flex Pin contact design pre-dates the advent of the MIL-DTL-83513 micro-miniature specification and today all MIL-DTL-83513 sockets mate properly with the Flex Pin. The one-piece unit is stamped from ASTM B194 beryllium copper (BeCu) to deliver high conductivity, low interference, and high resiliency. Its excellent spring properties enable it to withstand shock, vibration, and other rugged conditions and it easily passes military specification requirements.

Flex Pin contacts are plated with 50 micro-inches (1.27 $\mu$ in) of gold over 50 micro-inches (1.27 $\mu$ in) of nickel and are rated at 3 amps each. All pins are plated post-forming verify a non-porous surface. Our contacts are inspected by our quality assurance experts to guarantee perfection and performance.

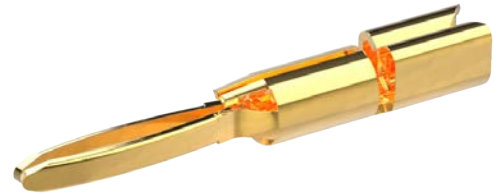

## SPACE LEVEL SCREENING [PER EEE-INST-002]

**Ordering steps**

Step 1 - Choose a suitable Micro or Nano connector

Step 2 - Choose a level of Space Screening

*Level 1 - Mission Critical (Highest Reliability)*

*Level 2 - High Reliability*

*Level 3 - Standard Reliability*

Step 3 - Select any added outgassing processing needed.

Step 4 - Specify chosen Ordering Codes from table below.

These codes should be used as separate line items on all Quote Requests and Purchase Orders as required.



**Ordering Codes (quoted as separate line items)**

Scening Level	Special Screening Only	Processing for Outgassing
Level 1 - Mission Critical	SPT1	All standard materials exhibit less than 1.0% TML without additional processing. Contact service for special requirements.
Level 2 - High Reliability	SPT2	
Level 3 - Standard Reliability	Standard	











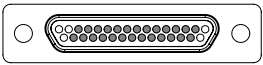

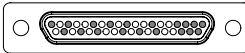
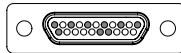
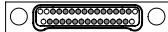

Inspection/Test	Micro (.050" center)		Nano (.025" center)	
	Level 1 Com'l/SCD	Level 2 Com'l/SCD	Level 1 Com'l/SCD	Level 2 Com'l/SCD
Visual	100%	100%	100%	100%
Mechanical	2 (0)	2 (0)	2 (0)	2 (0)
Voltage Rating (DWV)	100%	2 (0)	100%	2 (0)
Insulation Resistance	2 (0)	2 (0)	2 (0)	2 (0)
Temperature Cycling	2 (0)	2 (0)	2 (0)	2 (0)
Low Level Contact Resistance	2 (0)	2 (0)	2 (0)	2 (0)
Mating/Unmating Force	2 (0)	-	2 (0)	-
Solderability/Resistance to heat (SMT & Thru-Hole only)	2 (0)	-	2 (0)	-

*Note: NASA screening requirements from Table 2C & 2J of EEE-INST-002  
2(0) indicates 2 pieces tested, zero failures*

## HIGH-SPEED PROTOCOL GUIDE

The Omnetics High-Speed Protocol Guide, based on extensive internal research, provides connector options for various high-speed signaling protocols. The high-speed signaling specifications for each protocol were scrutinized extensively to provide an optimal pinout and ensure that the connectors meet or exceed the performance requirements.

When necessary, measurements were taken on the Omnetics connectors and directly compared to commercially available connectors. In these cases, Omnetics connectors outperformed the commercial connectors, yielding lower loss values across the critical frequencies. The pinouts for each available configuration are provided in the table below.

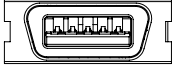
	Camera Link	Ethernet	HDMI	USB 3.0
Micro-D				
Nano-D				
Micro Strip				
Nano Strip				
Metal Micro Circular				
Metal Nano Circular				
QuickLock				

## MIL-DTL-83513 / MICRO-D SPECIFICATIONS

### 1. SCOPE

Omnetics' Micro-D products have been engineered and tested to meet or exceed the demanding qualification requirements of essential industry standards and specifications, including MIL-DTL-83513. Our microminiature connectors are available in both QPL and non-QPL versions and feature densely arrayed contacts with centerlines of .050" (1.27 mm). Our stringent inspection protocols ensure exceptional performance and conformity to all relevant requirements to support mission-critical applications.

### 2. PRECEDENCE OF REQUIREMENTS

The specifications herein are a select summary of those called out in MIL-DTL-83513. The complete controlled version of MIL-DTL-83513 from DLA takes precedence over these pages. For non-QPL parts, requirements of customer specifications and Omnetics' detail drawings will take top priority.

### 3. MATERIALS

#### 3.1. Contact Material

Contacts are suitably conductive copper based alloys per MIL-DTL-83513.

#### 3.2. Contact Finish

Contacts are gold plated in accordance with ASTM B488, type II, code C, class 1.27, 50 micro inches minimum thickness, over 50 micro inches minimum of nickel.

#### 3.3. Dielectric materials

Insulator material for connectors is LCP in accordance with ASTM D5138

#### 3.4. Shells

Shell options include the following materials:

*3.4.1.* Aluminum, alloy 6061 per SAE-AMS-QQ-A-200/8, plated as follows:

*3.4.1.1.* Electroless Nickel plated per SAE AMS-2404, class 3 or 4, grade B

*3.4.1.2.* Cadmium plated per SAE-AMS-QQ-P-416, type II, class 3, yellow chromate over nickel underplate

*3.4.1.3.* Black anodize per MIL-A-8625, Type II, Class 2

*3.4.2.* Stainless steel, 300 series, passivated per SAE AMS-2700, Type 2.

#### 3.5. Encapsulant

Epoxy shall be used as a potting material to prevent contact removal. A suitable material shall be used to enable the connector to pass all required mechanical, environmental and electrical testing.

#### 3.6. Interfacial Seals

Seals shall be made from silicone or fluorosilicone elastomer in accordance with A-A-59588 or SAE AMS-R-25988

#### 3.7. Mounting Hardware

Stainless steel, 300 series, passivated per SAE AMS-2700 except e-clips and lock washers. E-clips and lock washers are corrosion resistant steel, passivated per SAE AMS-QQ-P-35.

#### 3.8. Pigtail Wire

Insulated wire shall be in accordance with SAE AS-22759/11, SAE AS-22759/33 or NEMA-HP3. (NOTE: Connectors, which are pre-wired with SAE-AS-22759/33 and stored in a sealed environment, could experience corrosion. Omnetics takes this into consideration when packaging and storing connectors using this wire.

### 4. MECHANICAL REQUIREMENTS

#### 4.1. Durability

MIL-DTL-83513 requires that the connectors exhibit no mechanical or electrical defects detrimental to the operation of the connector after a minimum of 500 mating cycles.

#### 4.2. Insert Retention

Insulators will not be disturbed or dislodged from their shell when subjected to an axial load of 50 pounds per square inch (3.5 kilograms per square centimeter).

#### 4.3. Contact Retention

Contacts will withstand a 5 lb. (2.3 kg) axial load for a min. of 5 seconds.

#### 4.4. Crimp Tensile Strength

26 AWG SAE AS22759/11 wire will not break or pull from crimp joints with an applied force of less than 5.0 lb. (2.3 kg). 26 AWG SAE AS22759/33 shall not fail at a tensile force up to 10 lb. (4.6 kg). Wire breakage outside of the crimp does not constitute failure.

#### 4.5. Contact Engaging and Separation Force

Maximum engagement force is 6.0 ounces (170.1 g.) with the

## MIL-DTL-83513 / MICRO-D SPECIFICATIONS

minimum diameter test sleeve and minimum separation force is 0.5 ounces (14.2 g.) with the maximum diameter test sleeve. Tested using test sleeves as specified in MIL-STD-83513.

### 4.6. Connector Mating/Unmating Force

Maximum mating and Unmating force will be less than or equal to 10 ounces (283 g.) times the number of contacts.

### 4.7. Solderability

Printed circuit tails intended for SMT and Thru-Hole soldering and soldercups will meet the solderability requirements of MIL-STD-202, Method 208.

### 4.8. Solder Heat Resistance

Connectors shall show no evidence of distortion, contact misalignment, or damage to any area of the connector housing after the termination is heated with a soldering iron at 360°C per MIL-DTL-83513.

## 5. ELECTRICAL REQUIREMENTS

### 5.1. Current Capacity

Contacts can carry 3.0 amps in continuous operation from -55° C to 125 ° C.

### 5.2. Dielectric Withstanding Voltage (sea level)

Connectors will show no signs of breakdown or flash over at 600 volts ac, rms 60 Hz, per the DWV Test of EIA-364-20.

### 5.3. Dielectric Withstanding Voltage (70,000 feet)

Connectors will show no signs of breakdown or flash over at 150 volts ac, rms 60 Hz, per the DWV Test of EIA-364-20.

### 5.4. Insulation Resistance

5,000 Megohms minimum @ 500 VDC IAW EIA-364-21.

### 5.5. Contact Resistance

70 millivolt drop maximum with a 2.5 amperes test current in accordance with EIA-364-06 using 26 AWG SAE AS22759/11 wire, 80 millivolt drop maximum using 26 AWG SAE AS22759/33 wire.

### 5.6. Low Level Contact Resistance

28 millivolt drop maximum with a test current of 100 milliamperes maximum in accordance with EIA-364-23 using 26 AWG SAE AS22759/11 wire, 32 millivolt drop maximum using 26 AWG SAE

AS22759/33 wire.

### 5.7. Magnetic Permeability

The relative magnetic permeability will not exceed 2 mu when tested with an instrument IAW ASTM A342/A342M, excluding hardware.

## 6. ENVIRONMENTAL REQUIREMENTS

### 6.1. Shock

50 G peak acceleration per EIA-364-27, test condition E; when tested for mechanical shock, mated connectors shall not be damaged, and there shall be no loosening of parts. There shall be no interruption of electrical continuity or current flow longer than 1 microsecond.

### 6.2. Vibration

20 G peak acceleration over a 12 hour duration per EIA-364-28, test condition IV; when tested for vibration, mated connectors shall not be damaged, and there shall be no loosening of parts. There shall be no interruption of electrical continuity or current flow longer than 1 microsecond.

### 6.3. Salt spray (corrosion)

Mated connectors will show no exposure of base metal due to corrosion which will affect performance after be subjected to the salt spray test of EIA-364-26 condition B. All connector shell finishes must withstand 48 hours of salt spray. Following the test all connectors shall meet the specified requirements for connector mating/unmating forces, contact retention, contact resistance, and low-signal level contact resistance.

### 6.4. Thermal Vacuum Outgassing

Space class connector assemblies shall have a maximum total mass loss (TML) of 1.0 percent of the original specimen mass, and shall have a maximum volatile condensable material (VCM) content of 0.1 percent of the original specimen mass.

### 6.5. Fluid Immersion

Connectors will continue to adhere to the mating force requirements set forth by MIL-DTL-83513 after be subjected to a 20 hour immersion in synthetic lubricating oil and 1 hour immersion in a coolant-dielectric fluid synthetic silicate ester base lubricant (Coolanol 25). There will be no degradation of the insulators or encapsulates.

### 6.6. Material Fungus Resistance

Materials used in the construction of these connectors are



## MIL-DTL-83513 / MICRO-D SPECIFICATIONS

fungus inert in accordance with Method 508.6 of MIL-STD-810.

### 6.7. Thermal Shock

Connectors will withstand 5 cycles of thermal shock from -55° C to 125 ° C per EIA-364-32, condition I. There will be no detrimental damage or degradation of the electrical performance.

### 6.8. Humidity

These connectors will meet all the humidity testing requirements in accordance with EIA-364-31, Test Method IV (excluding steps 7a & 7b). Post humidity, the connectors will pass a 360 volt DWV

test. Within 1 to 2 hours the connectors will have a minimum of 1 megohm insulation resistance when tested at 100 VDC. Following 24 hours, the connectors will have a minimum of 1,000 megohm insulation resistance when tested at 100 VDC.

### 6.9. Marking Permanency

Any marking on the connector shells of these micro connectors shall meet the requirements of MIL-STD-202, Method 215.

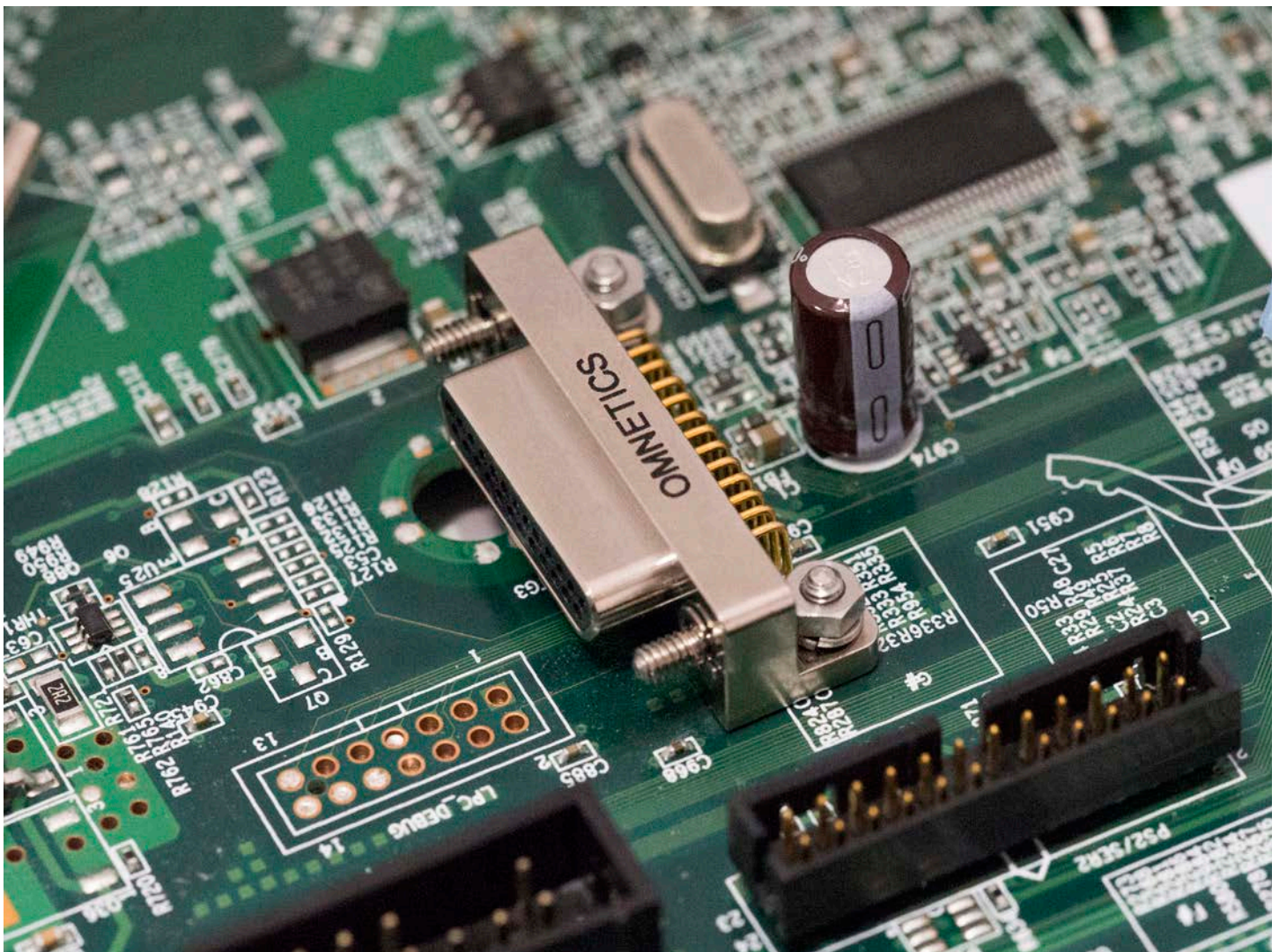

## SOLDER CUP MICRO-D QPL

Omnetics Micro-D Connectors serve the military and elevate aeronautics applications. They are an outstanding choice for critical applications in every industry where reliability and performance are paramount. Our scaled-down refinement of the classic D-sub connector serves SWaP goals with reduced sizes and lightweight materials. These powerful components meet or exceed the rigorous requirements of MIL-DTL-83513. Our standard and COTS models are available in shell styles that range from 9 to 51 contacts. Omnetics' innovative flex pin design helps deliver uninterrupted connectivity under strenuous conditions where shock and vibration are everyday realities. The gold-plated flex pin is designed for >2,000 mating cycles. These connectors are engineered to operate at temperatures ranging from -55°C to 125°C, making them a solid choice for applications anywhere on Earth.



### Electro-Mechanical Specifications

TYPE	PERFORMANCE
Durability	>2000 Mating Cycles Max [500 Mating Cycles min]*
Temperature	-55°C to +125°C
Current rating	3 Amps per contact
Voltage Rating (DWV)	600 VAC RMS Sea Level
Insulation Resistance	5,000 Megohms @ 500 VDC
Shock	50 g's with no discontinuities > 1 microsecond
Vibration	20 g's with no discontinuities > 1 microsecond
Thermal Vacuum Outgassing	1.0% max TML, 0.1% max CVCM
Contact Resistance	26 milliohms (65 mV) max @ 2.5 Amps per MIL-DTL-83513
Mating/Unmating Force	3 oz (85g) typical per contact*

### Material Specifications

TYPE	PERFORMANCE
Shell Material and Finish	Aluminum Shell, Cadmium Plated Aluminum Shell, Electroless Nickel Plated Stainless Steel Shell, Passivated
Insulator	Thermoplastic per MIL-DTL-83513
Contact	Copper Alloy per MIL-DTL-83513
Contact Finish	Gold per ASTM B488, Type II, Class 1.27, Code C Over Nickel Underplate
Encapsulant	Epoxy

\*MIL-DTL-83513 specification minimum requirement

## SOLDER CUP MICRO-D QPL ORDERING GUIDE



<b>1</b> Component Assembly	<b>MMDP-01</b> Plug, Pin Contacts	<b>MMDS-02</b> Receptacle, Socket Contacts
<b>2</b> Number of Contacts	<b>A</b> 9 contacts <b>B</b> 15 Contacts <b>C</b> 21 Contacts <b>D</b> 25 Contacts	<b>E</b> 31 Contacts <b>F</b> 37 Contacts <b>G</b> 51 Contacts
<b>3</b> Shell Material and Finish	<b>C</b> Aluminum, Cadmium Finish	<b>N</b> Aluminum, Electroless Nickel Finish (STD)
	<b>P</b> Stainless Steel, Passivated	

## DUAL ROW MICRO-D DISCRETE WIRED QPL

Omnetics MIL-DTL-83513 Micro-D Connectors are ideal for critical, high reliability industries including aerospace, military and petroleum. They are also used in devices such as optics, guidance systems, on-board equipment, space, and UAV systems. They are built to meet or exceed the specifications of MIL-DTL-83513. These highly rugged and compact designs are available in shell styles from 9 to 51 contacts. The Micro-D connectors incorporate Omnetics one-piece flex pin design for greater shock and vibration resistance. The high reliability gold plated flex pin is designed for >2,000 mating cycles. Omnetics Micro-D connectors will operate from -55°C to 125°C.



### Electro-Mechanical Specifications

TYPE	PERFORMANCE
Durability	>2000 Mating Cycles Max [500 Mating Cycles min]*
Temperature	-55°C to +125°C
Current rating	3 Amps per contact
Voltage Rating (DWV)	600 VAC RMS Sea Level
Insulation Resistance	5,000 Megohms @ 500 VDC
Shock	50 g's with no discontinuities > 1 microsecond
Vibration	20 g's with no discontinuities > 1 microsecond
Thermal Vacuum Outgassing	1.0% max TML, 0.1% max CVCM
Contact Resistance	26 milliohms (65 mV) max @ 2.5 Amps per MIL-DTL-83513
Mating/Unmating Force	3 oz (85g) typical per contact*

### Material Specifications

TYPE	PERFORMANCE
Shell Material and Finish	Aluminum Shell, Cadmium Plated Aluminum Shell, Electroless Nickel Plated Stainless Steel Shell, Passivated
Insulator	Thermoplastic per MIL-DTL-83513
Contact	Copper Alloy per MIL-DTL-83513
Contact Finish	Gold per ASTM B488, Type II, Class 1.27, Code C Over Nickel Underplate
Encapsulant	Epoxy

\*MIL-DTL-83513 specification minimum requirement

## DUAL ROW MICRO-D DISCRETE WIRED QPL ORDERING GUIDE

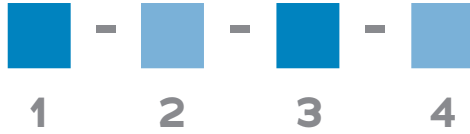

<b>1</b> Component Assembly	<b>MMDP-03</b> Plug, Pin Contacts <b>MMDS-04</b> Receptacle, Socket Contacts
<b>2</b> Number of Contacts	<b>A</b> 9 contacts <b>B</b> 15 Contacts <b>C</b> 21 Contacts <b>D</b> 25 Contacts <b>E</b> 31 Contacts <b>F</b> 37 Contacts <b>G</b> 51 Contacts
<b>3</b> Wire Type	See M83513 Wire Type table below
<b>4</b> Shell Material and Finish	<b>C</b> Aluminum, Cadmium Finish <b>N</b> Aluminum, Electroless Nickel Finish (Std) <b>P</b> Stainless Steel, Passivated

### M83513 Wire Type

Wire Type	Specification	Length (Inches)
01	M22759/11-26-9	18
02		36
03	M22759/11-26-#	18
04		36
09	M22759/33-26-9	18
10		36
11	M22759/33-26-#	18
12		36
13	M22759/11-26-9	72
14	M22759/11-26-#	
15	M22759/33-26-9	
16	M22759/33-26-#	

# METAL SHELL MICRO-D DISCRETE LEADWIRE (TYPE WD)

Omnetics **Metal Shell Micro-D Discrete Leadwire** Connectors deliver exceptional performance under demanding conditions common to the military, medical, and aeronautics environments. These high-reliability connectors meet or exceed the rugged requirements of MIL-DTL-83513. They are available in two, three, or four contact rows. RoHS and overmolded versions are available upon request. These small form factor connectors feature reduced size and weight to meet SWaP goals in next-generation technologies.

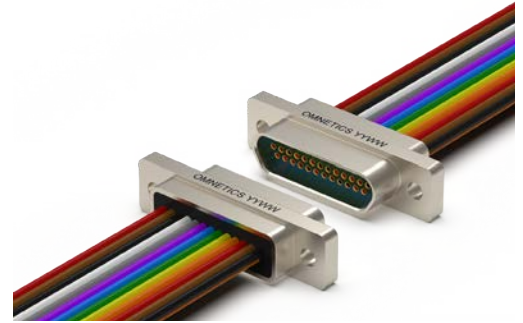

## Electro-Mechanical Specifications

TYPE	PERFORMANCE
Durability	> 2000 Mating Cycles min
Temperature	-55°C to +125°C (200 °C w/HTE)
Current rating	3 Amps per contact per MIL-DTL-83513
Voltage Rating (DWV)	600 VAC RMS Sea Level
Insulation Resistance	5,000 Megohms @ 500 VDC
Shock	50 g's with no discontinuities > 1 microsecond
Vibration	20 g's with no discontinuities > 1 microsecond
Thermal Vacuum Outgassing	1.0% max TML, 0.1% max CVCM - NASA SP-R-0022
Contact Resistance	26 milliohms (65 mV) max @ 2.5 Amps per MIL-DTL-83513
Mating/Unmating Force	3 oz. (.85g) typical per contact

## Material Specifications

TYPE	PERFORMANCE
Contact	Copper Alloy Per MIL-DTL-83513
Contact Finish	Gold per ASTM B488, Type II, Class 1.27, Code C Over Nickel Underplate
Insulator	Thermoplastic per MIL-DTL-83513
Interfacial Seal	Silicone Elastomer per A-A-59588
Hardware	Stainless Steel, 300 Series, Passivated per SAE AMS-2700

## Shell Options

MATERIAL	FINISH
Aluminum 6061	Electroless Nickel per SAE-AMS-2404
Stainless Steel, 300 Series	Passivated per SAE-AMS-2700

# METAL SHELL MICRO-D DISCRETE LEADWIRE (TYPE WD)

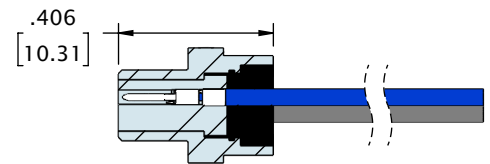
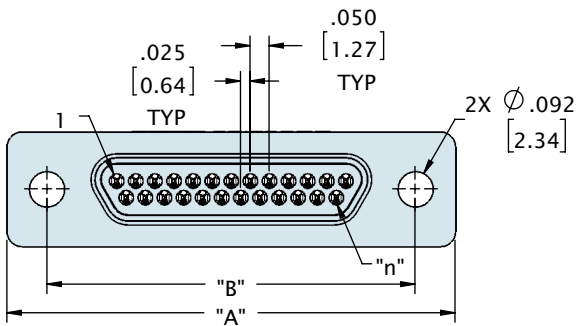
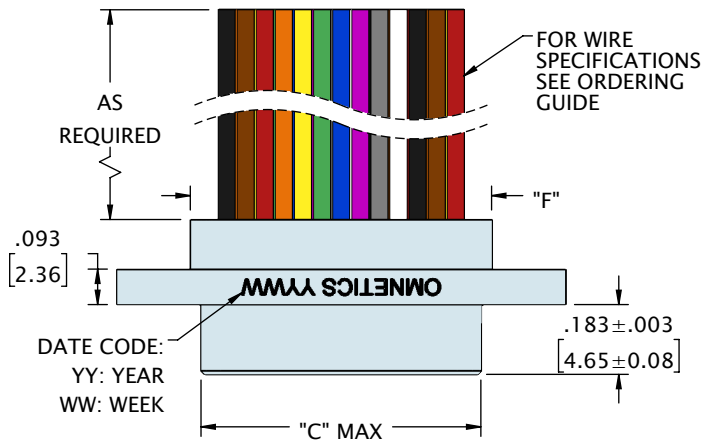

4 ROW CONNECTOR

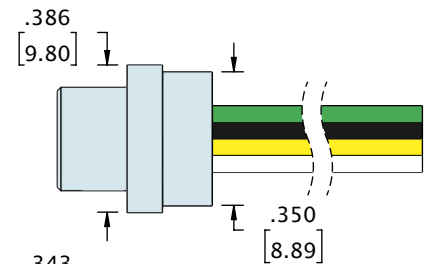

3 ROW CONNECTOR

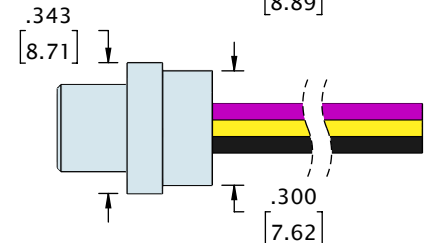

2 ROW CONNECTOR

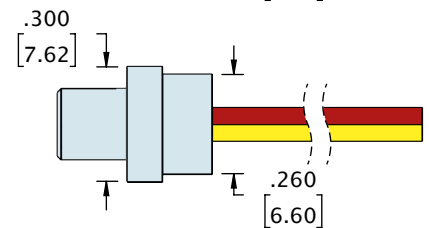

CONTACTS	ROWS	"A"	"B"	"C"	"F"
9	2	.775 [19.69]	.565 [14.35]	.334 [8.48]	.390 [9.91]
15	2	.925 [23.50]	.715 [18.16]	.484 [12.29]	.540 [13.72]
21	2	1.075 [27.31]	.865 [21.97]	.634 [16.10]	.690 [17.53]
25	2	1.175 [29.85]	.965 [24.51]	.734 [18.64]	.790 [20.07]
31	2	1.325 [33.66]	1.115 [28.32]	.884 [22.45]	.940 [23.88]
37	2	1.475 [37.47]	1.265 [32.13]	1.034 [26.26]	1.090 [27.69]
51	2	1.825 [46.36]	1.615 [41.02]	1.384 [35.15]	1.440 [36.58]
51	3	1.425 [36.20]	1.215 [30.86]	.984 [24.99]	1.040 [26.42]
69	3	1.725 [43.82]	1.515 [38.48]	1.284 [32.61]	1.340 [34.04]
100	4	2.160 [54.86]	1.800 [45.72]	1.384 [35.15]	1.432 [36.37]

DIMENSIONS IN [ ] ARE IN MILLIMETERS AND ARE FOR REFERENCE ONLY

# METAL SHELL MICRO-D DISCRETE LEADWIRE (TYPE WD)

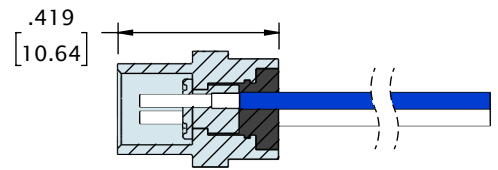
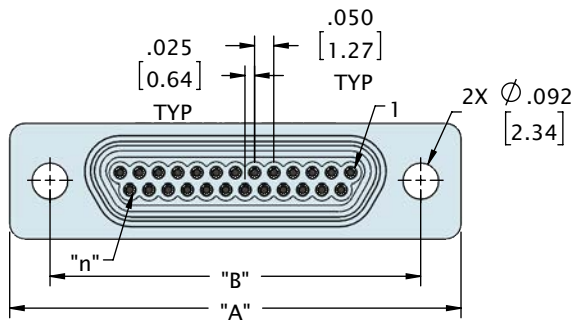
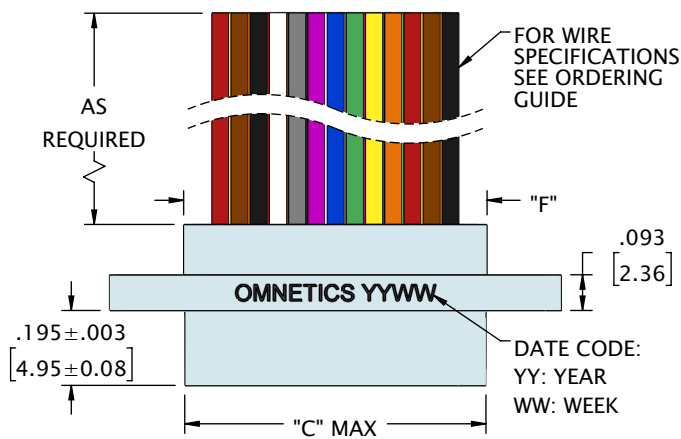
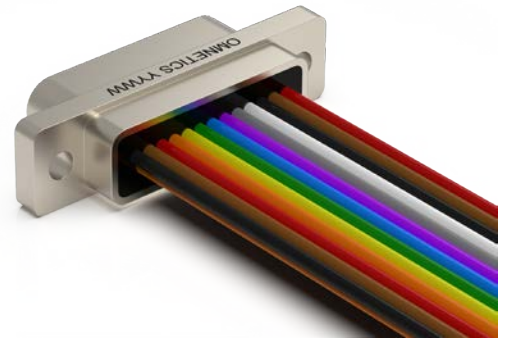
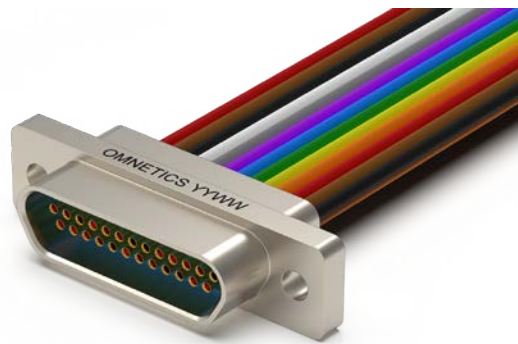

4 ROW CONNECTOR

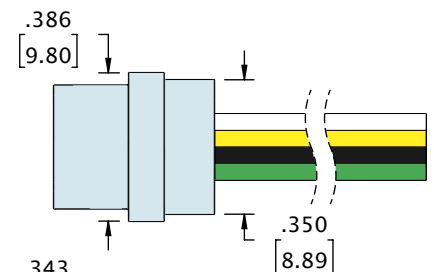

3 ROW CONNECTOR

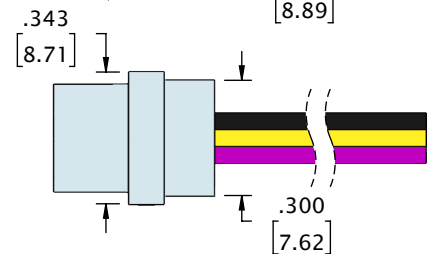

2 ROW CONNECTOR

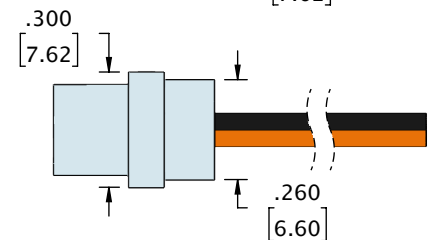

CONTACTS	ROWS	"A"	"B"	"C"	"F"
9	2	.775 [19.69]	.565 [14.35]	.400 [10.17]	.390 [9.91]
15	2	.925 [23.50]	.715 [18.16]	.550 [13.98]	.540 [13.72]
21	2	1.075 [27.31]	.865 [21.97]	.700 [17.79]	.690 [17.53]
25	2	1.175 [29.85]	.965 [24.51]	.800 [20.33]	.790 [20.07]
31	2	1.325 [33.66]	1.115 [28.32]	.950 [24.14]	.940 [23.88]
37	2	1.475 [37.47]	1.265 [32.13]	1.100 [27.95]	1.090 [27.69]
51	2	1.825 [46.36]	1.615 [41.02]	1.450 [36.84]	1.440 [36.58]
51	3	1.425 [36.20]	1.215 [30.86]	1.050 [26.68]	1.040 [26.42]
69	3	1.725 [43.82]	1.515 [38.48]	1.350 [34.29]	1.340 [34.04]
100	4	2.160 [54.86]	1.800 [45.72]	1.450 [36.83]	1.432 [36.37]

DIMENSIONS IN [ ] ARE IN MILLIMETERS AND ARE FOR REFERENCE ONLY



# METAL SHELL MICRO-D DISCRETE LEADWIRE (TYPE WD)

## ORDERING GUIDE



<b>1 Series</b>	<b>MMDP</b> Metal Micro-D Pin	<b>MMDS</b> Metal Micro-D Socket
<b>2 Number of Contacts</b>	<b>009</b> <b>015</b> <b>021</b> <b>025</b> <b>031</b> <b>037</b> <b>051*</b> <b>069</b> <b>100</b>	
	* Use <b>512</b> for Two Rows <b>051</b> and <b>513</b> for Three Rows <b>051</b>	
<b>3 Termination Type</b>	<b>WD</b> Discrete Leadwire	
<b>4 Wire AWG</b>	<b>4</b> 24 AWG <b>6</b> 26 AWG (STD)	<b>8</b> 28 AWG <b>0</b> 30 AWG
<b>5 Wire Type</b>	<b>Q</b> Nema HP3 (STD) <b>R</b> M22759/11	<b>S</b> M22759/33 <b>X</b> Other
<b>6 Wire Length (inches)</b>	<b>18.0</b> 18.00 (STD)	<b>XX.X</b> Custom length
<b>7 Color Scheme</b>	<b>1</b> 10 Repeating <b>2</b> Blue <b>3</b> White	<b>4</b> Non Repeating <b>5</b> Yellow
<b>8 Shell Material &amp; Finish</b>	<b>N</b> Aluminum Shell, Electroless Nickel Plated <b>B</b> Aluminium Shell, Black Anodized	<b>CD</b> Aluminium Shell, Cadmium Plated <b>P</b> Stainless Steel Shell, Passivated
<b>9 Hardware</b>	<b>00</b> None, Ø .092 Hole <b>02</b> Jackscrews, STD Length, Hex (MMDP - STD) <b>04</b> Jackscrews, Long Length, Hex <b>06</b> Float Mount, Front Mounted <b>08</b> Non-Removable	<b>01</b> Fixed Jack-posts (MMDS - STD) <b>03</b> Jackscrews, STD Length, Slotted <b>05</b> Jackscrews, Long Length, Slotted <b>07</b> Float Mount, Rear Mounted <b>YY</b> Non Standard Hardware
<b>10 Common Options</b>	<b>PA</b> Panel Mount Rear, O-Ring <b>BS1</b> 45 Degree Round Entry, Micro-D Backshell <b>BS2</b> Straight Oval Entry, Micro-D Backshell <b>BS3</b> 90 Degree Oval Entry, Micro-D Backshell <b>BS4</b> 45 Degree Elliptical Entry, Micro-D Backshell <b>BS5</b> Straight Elliptical Entry, Split Micro-D Backshell <b>BS6</b> 45 Degree Round Entry, Split Micro-D Backshell	<b>PB</b> Panel Mount, Rear <b>IBS</b> Integrated Backshell <b>BSY</b> Custom Backshell <b>HT</b> High Temp Epoxy <b>RH</b> RoHS Compliant
<b>11 Shield / Jacket</b>	<b>D</b> Slip On Metal Braid <b>E</b> Machine Braid <b>F</b> Flexo Braid <b>J</b> Nomex Braid <b>ST</b> Shrink Tube	
<b>12 Mod Codes</b>	<b>M10</b> Keyed <b>M30</b> Ground Spring <b>M50</b> Space Grade Micro-D, SPT1 <b>M53</b> Space Grade Micro-D, SPT2	
<b>13 Special Instructions</b>	<b>YYY</b> Describe anything that is not covered in standard options	

# METAL SHELL MICRO-D SOLDER CUP (TYPE SS)

Omnetics **Metal Shell Micro-D Solder Cup** Connectors simplify connections for designs that require soldering. These connectors are well-suited for high-reliability board to wire I/O and wire-to-wire applications. They serve critical technologies in the military, medical, and aeronautics industries. They provide exceptional performance even under conditions that include shock and vibration. These connectors meet or exceed the rugged requirements of MIL-DTL-83513 and are available in two, three, or four rows.



## Electro-Mechanical Specifications

TYPE	PERFORMANCE
Durability	> 2000 Mating Cycles min
Temperature	-55°C to +125°C (200 °C w/HTE)
Current rating	3 Amps per contact per MIL-DTL-83513
Voltage Rating (DWV)	600 VAC RMS Sea Level
Insulation Resistance	5,000 Megohms @ 500 VDC
Shock	50 g's with no discontinuities > 1 microsecond
Vibration	20 g's with no discontinuities > 1 microsecond
Thermal Vacuum Outgassing	1.0% max TML, 0.1% max CVCM - NASA SP-R-0022
Contact Resistance	26 milliohms (65 mV) max @ 2.5 Amps per MIL-DTL-83513
Mating/Unmating Force	3 oz. (.85g) typical per contact

## Material Specifications

TYPE	PERFORMANCE
Contact	Copper Alloy Per MIL-DTL-83513
Contact Finish	Gold per ASTM B488, Type II, Class 1.27, Code C Over Nickel Underplate
Insulator	Thermoplastic per MIL-DTL-83513
Interfacial Seal	Silicone Elastomer per A-A-59588
Hardware	Stainless Steel, 300 Series, Passivated per SAE AMS-2700

## Shell Options

MATERIAL	FINISH
Aluminum 6061	Electroless Nickel per SAE-AMS-2404
Stainless Steel, 300 Series	Passivated per SAE-AMS-2700

# METAL SHELL MICRO-D SOLDER CUP (TYPE SS)

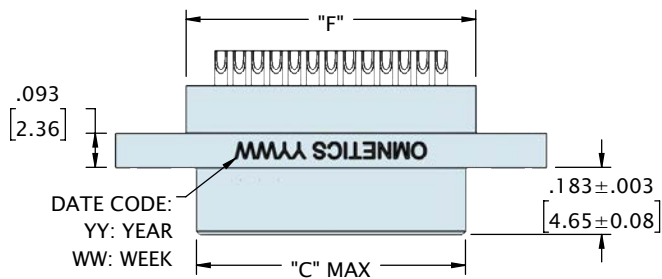

4 ROW CONNECTOR

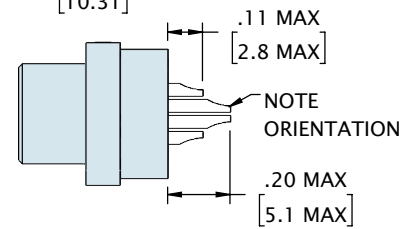
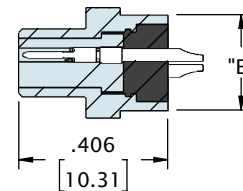

3 ROW CONNECTOR

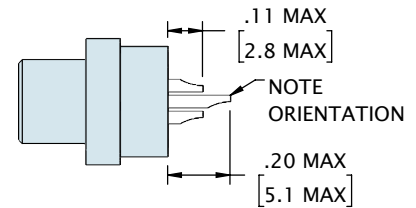

2 ROW CONNECTOR

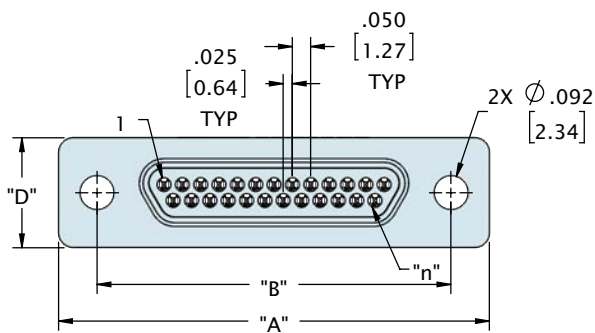
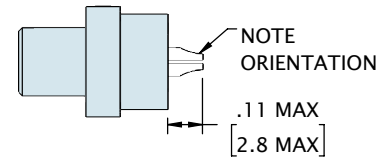

CONTACTS	ROWS	"A"	"B"	"C"	"D"	"E"	"F"
9	2	.775 [19.69]	.565 [14.35]	.334 [8.48]	.300 [7.62]	.260 [6.60]	.390 [9.91]
15	2	.925 [23.50]	.715 [18.16]	.484 [12.29]	.300 [7.62]	.260 [6.60]	.540 [13.72]
21	2	1.075 [27.31]	.865 [21.97]	.634 [16.10]	.300 [7.62]	.260 [6.60]	.690 [17.53]
25	2	1.175 [29.85]	.965 [24.51]	.734 [18.64]	.300 [7.62]	.260 [6.60]	.790 [20.07]
31	2	1.325 [33.66]	1.115 [28.32]	.884 [22.45]	.300 [7.62]	.260 [6.60]	.940 [23.88]
37	2	1.475 [37.47]	1.265 [32.13]	1.034 [26.26]	.300 [7.62]	.260 [6.60]	1.090 [27.69]
51	2	1.825 [46.36]	1.615 [41.02]	1.384 [35.15]	.300 [7.62]	.260 [6.60]	1.440 [36.58]
51	3	1.425 [36.20]	1.215 [30.86]	.984 [24.99]	.343 [8.71]	.300 [7.62]	1.040 [26.42]
69	3	1.725 [43.82]	1.515 [38.48]	1.284 [32.61]	.343 [8.71]	.300 [7.62]	1.340 [34.04]
100	4	2.160 [54.86]	1.800 [45.72]	1.384 [35.15]	.386 [9.80]	.350 [8.89]	1.432 [36.37]

DIMENSIONS IN [ ] ARE IN MILLIMETERS AND ARE FOR REFERENCE ONLY

# METAL SHELL MICRO-D SOLDER CUP (TYPE SS)

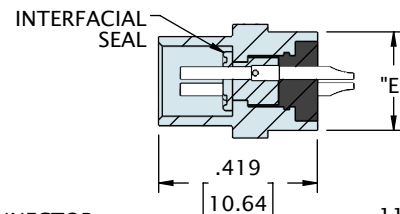
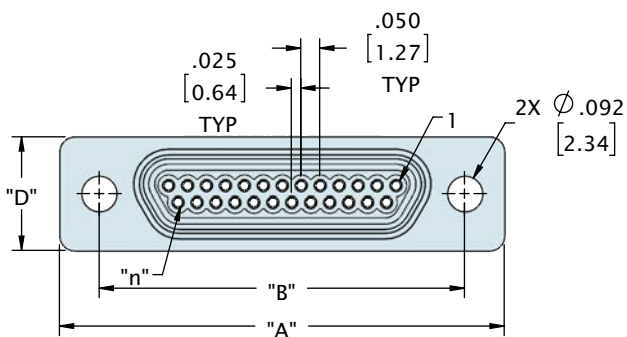
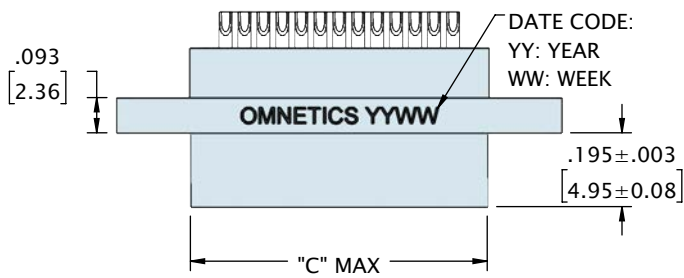
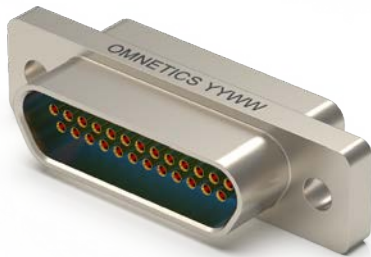

4 ROW CONNECTOR

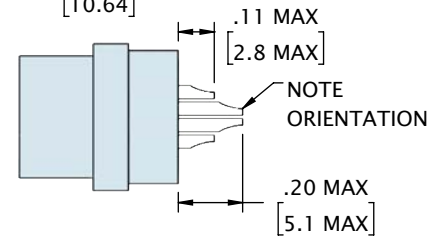

3 ROW CONNECTOR

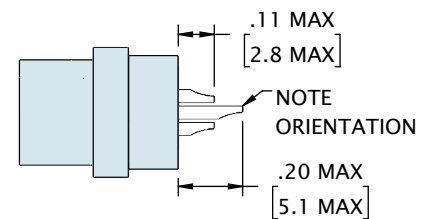

2 ROW CONNECTOR

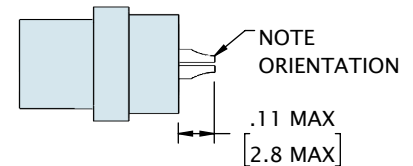

CONTACTS	ROWS	"A"	"B"	"C"	"D"	"E"	"F"
9	2	.775 [19.69]	.565 [14.35]	.400 [10.17]	.300 [7.62]	.260 [6.60]	.390 [9.91]
15	2	.925 [23.50]	.715 [18.16]	.550 [13.98]	.300 [7.62]	.260 [6.60]	.540 [13.72]
21	2	1.075 [27.31]	.865 [21.97]	.700 [17.79]	.300 [7.62]	.260 [6.60]	.690 [17.53]
25	2	1.175 [29.85]	.965 [24.51]	.800 [20.33]	.300 [7.62]	.260 [6.60]	.790 [20.07]
31	2	1.325 [33.66]	1.115 [28.32]	.950 [24.14]	.300 [7.62]	.260 [6.60]	.940 [23.88]
37	2	1.475 [37.47]	1.265 [32.13]	1.100 [27.95]	.300 [7.62]	.260 [6.60]	1.090 [27.69]
51	2	1.825 [46.36]	1.615 [41.02]	1.450 [36.84]	.300 [7.62]	.260 [6.60]	1.440 [36.58]
51	3	1.425 [36.20]	1.215 [30.86]	1.050 [26.68]	.343 [8.71]	.300 [7.62]	1.040 [26.42]
69	3	1.725 [43.82]	1.515 [38.48]	1.350 [34.29]	.343 [8.71]	.300 [7.62]	1.340 [34.04]
100	4	2.160 [54.86]	1.800 [45.72]	1.450 [36.83]	.386 [9.80]	.350 [8.89]	1.432 [36.37]

DIMENSIONS IN [ ] ARE IN MILLIMETERS AND ARE FOR REFERENCE ONLY

## ORDERING GUIDE

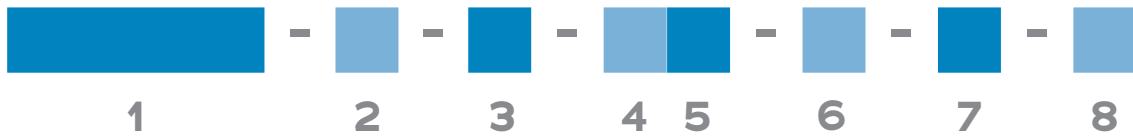

<b>1 Series</b>	<b>MMDP</b> Metal Micro-D Pin	<b>MMDS</b> Metal Micro-D Socket
<b>2 Number of Contacts</b>	<b>009</b> <b>015</b> <b>021</b> <b>025</b> <b>031</b> <b>037</b> <b>051*</b> <b>069</b> <b>100</b>	
	* Use <b>512</b> for Two Rows <b>051</b> and <b>513</b> for Three Rows <b>051</b>	
<b>3 Termination Type</b>	<b>SS</b> Soldercup, 26 AWG (STD) <b>SS4</b> Soldercup, 24 AWG	
<b>4 Shell Material &amp; Finish</b>	<b>N</b> Aluminum Shell, Electroless Nickel Plated <b>B</b> Aluminium Shell, Black Anodized	<b>CD</b> Aluminium Shell, Cadmium Plated <b>P</b> Stainless Steel Shell, Passivated
<b>5 Hardware</b>	<b>00</b> None, Ø .092 Hole <b>02</b> Jackscrews, STD Length, Hex (MMDP - STD) <b>04</b> Jackscrews, Long Length, Hex <b>06</b> Float Mount, Front Mounted <b>08</b> Non-Removable	<b>01</b> Fixed Jack-posts (MMDS - STD) <b>03</b> Jackscrews, STD Length, Slotted <b>05</b> Jackscrews, Long Length, Slotted <b>07</b> Float Mount, Rear Mounted <b>YY</b> Non Standard Hardware
<b>6 Common Options</b>	<b>PA</b> Panel Mount Rear, O-Ring <b>BS1</b> 45 Degree Round Entry, Micro-D Backshell <b>BS2</b> Straight Oval Entry, Micro-D Backshell <b>BS3</b> 90 Degree Oval Entry, Micro-D Backshell <b>BS4</b> 45 Degree Elliptical Entry, Micro-D Backshell <b>BS5</b> Straight Elliptical Entry, Split Micro-D Backshell <b>BS6</b> 45 Degree Round Entry, Split Micro-D Backshell	<b>PB</b> Panel Mount, Rear <b>BSY</b> Custom Backshell <b>HT</b> High Temp Epoxy <b>RH</b> RoHS Compliant
<b>7 Mod Codes</b>	<b>M10</b> Keyed <b>M50</b> Space Grade Micro-D, SPT1	<b>M30</b> Ground Spring <b>M53</b> Space Grade Micro-D, SPT2
<b>8 Special Instructions</b>	<b>YYY</b> Describe anything that is not covered in standard options	

# METAL SHELL MICRO-D HORIZONTAL SURFACE MOUNT (TYPE HO)

Omnetics **Micro-D Horizontal Surface Mount** Connectors are an excellent choice for high-reliability applications in which a secure connection is needed directly on the board. These connectors are selected by designers of military, medical, and aerospace equipment and are used in devices such as guidance systems, optics, and on-board equipment. They are built to meet or exceed the rugged requirements of MIL-DTL-83513 and feature Omnetics' innovative one-piece flex pin design to protect the integrity of the system even under shock and vibration. Shell options include aluminum with nickel plating, stainless steel, and aluminum with cadmium plating.

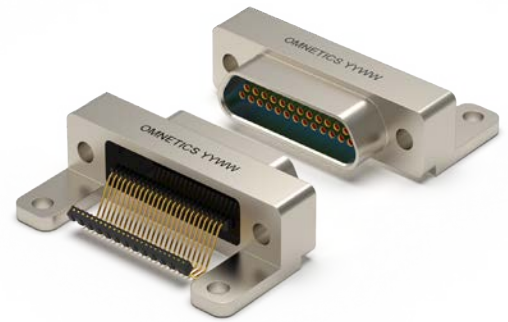

## Electro-Mechanical Specifications

TYPE	PERFORMANCE
Durability	> 2000 Mating Cycles min
Temperature	-55°C to +125°C (200 °C w/HTE)
Current rating	3 Amps per contact per MIL-DTL-83513
Voltage Rating (DWV)	600 VAC RMS Sea Level
Insulation Resistance	5,000 Megohms @ 500 VDC
Shock	50 g's with no discontinuities > 1 microsecond
Vibration	20 g's with no discontinuities > 1 microsecond
Thermal Vacuum Outgassing	1.0% max TML, 0.1% max CVCM - NASA SP-R-0022
Contact Resistance	26 milliohms (65 mV) max @ 2.5 Amps per MIL-DTL-83513
Mating/Unmating Force	3 oz. (.85g) typical per contact

## Material Specifications

TYPE	PERFORMANCE
Contact	Copper Alloy Per MIL-DTL-83513
Contact Finish	Gold per ASTM B488, Type II, Class 1.27, Code C Over Nickel Underplate
Insulator	Thermoplastic per MIL-DTL-83513
Interfacial Seal	Silicone Elastomer per A-A-59588
Hardware	Stainless Steel, 300 Series, Passivated per SAE AMS-2700

## Shell Options

MATERIAL	FINISH
Aluminum 6061	Electroless Nickel per SAE-AMS-2404
Stainless Steel, 300 Series	Passivated per SAE-AMS-2700

# METAL SHELL MICRO-D HORIZONTAL SURFACE MOUNT (TYPE HO)

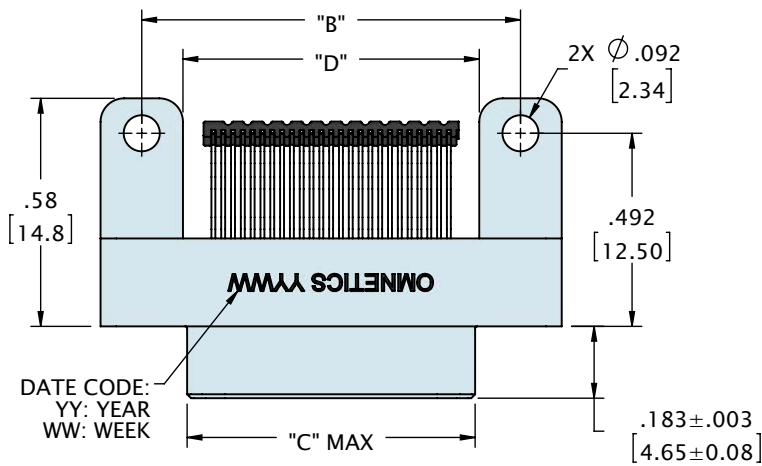
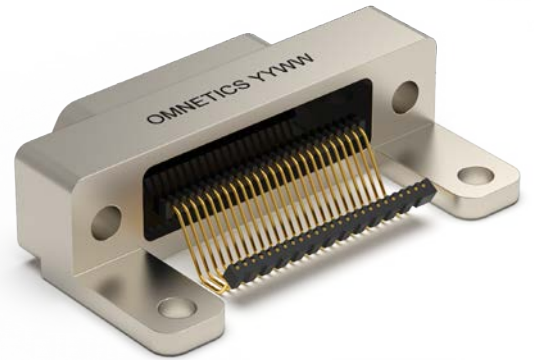

See page 158 for recommended board layout

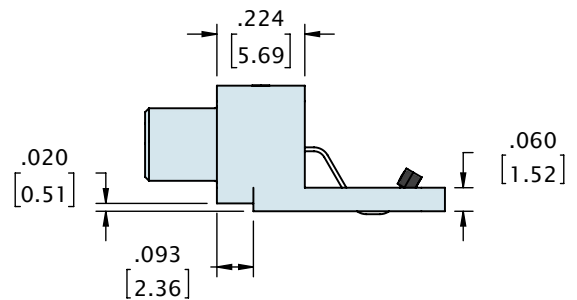
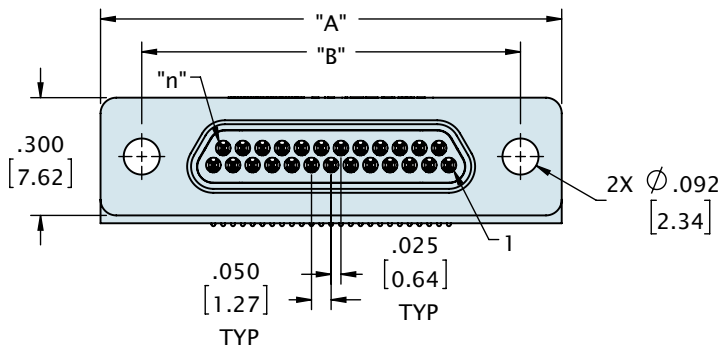
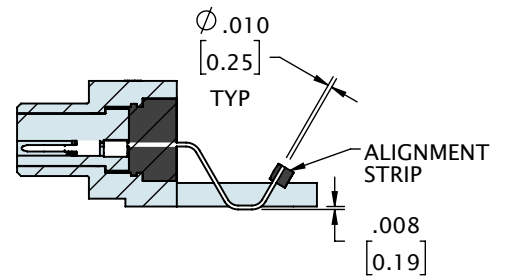

CONTACTS	ROWS	"A"	"B"	"C"	"D"
9	2	.775 [19.69]	.565 [14.35]	.334 [8.48]	.355 [9.02]
15	2	.925 [23.50]	.715 [18.16]	.484 [12.29]	.505 [12.83]
21	2	1.075 [27.31]	.865 [21.97]	.634 [16.10]	.655 [16.64]
25	2	1.175 [29.85]	.965 [24.51]	.734 [18.64]	.755 [19.18]
31	2	1.325 [33.66]	1.115 [28.32]	.884 [22.45]	.905 [22.99]
37	2	1.475 [37.47]	1.265 [32.13]	1.034 [26.26]	1.055 [26.80]
51	2	1.825 [46.36]	1.615 [41.02]	1.384 [35.15]	1.405 [35.69]

DIMENSIONS IN [ ] ARE IN MILLIMETERS AND ARE FOR REFERENCE ONLY

# METAL SHELL MICRO-D HORIZONTAL SURFACE MOUNT (TYPE HO)

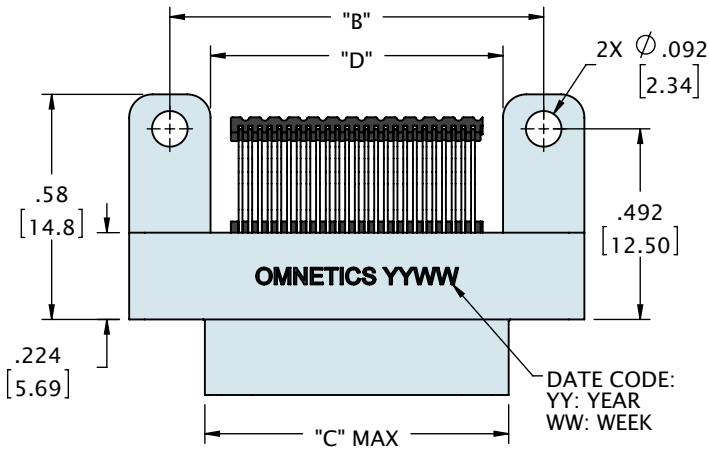

See page 158 for recommended board layout

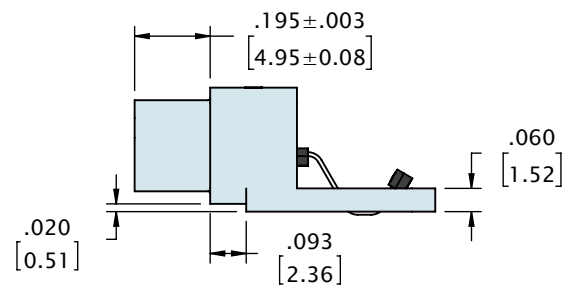
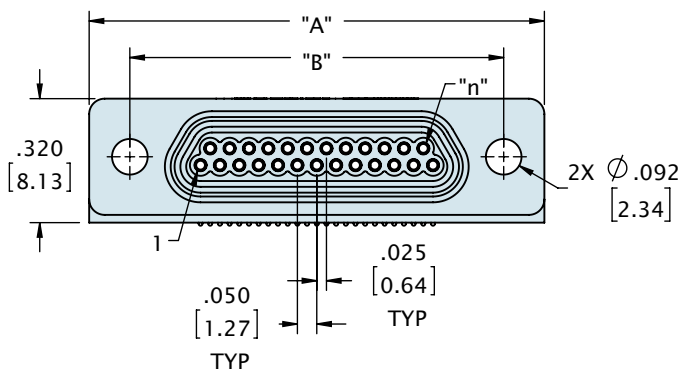
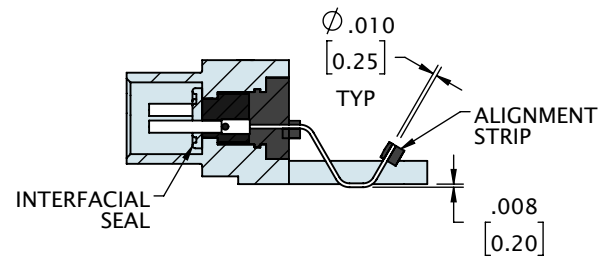

CONTACTS	ROWS	"A"	"B"	"C"	"D"
9	2	.775 [19.69]	.565 [14.35]	.400 [10.17]	.355 [9.02]
15	2	.925 [23.50]	.715 [18.16]	.550 [13.98]	.505 [12.83]
21	2	1.075 [27.31]	.865 [21.97]	.700 [17.79]	.655 [16.64]
25	2	1.175 [29.85]	.965 [24.51]	.800 [20.33]	.755 [19.18]
31	2	1.325 [33.66]	1.115 [28.32]	.950 [24.14]	.905 [22.99]
37	2	1.475 [37.47]	1.265 [32.13]	1.100 [27.95]	1.055 [26.80]
51	2	1.825 [46.36]	1.615 [41.02]	1.450 [36.84]	1.405 [35.69]

DIMENSIONS IN [ ] ARE IN MILLIMETERS AND ARE FOR REFERENCE ONLY



## ORDERING GUIDE

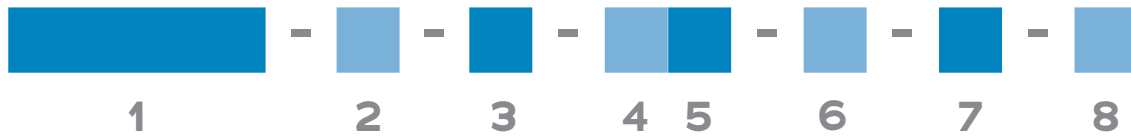

<b>1 Series</b>	<b>MMDP</b> Metal Micro-D Pin	<b>MMDS</b> Metal Micro-D Socket
<b>2 Number of Contacts</b>	<b>O09</b> <b>O15</b> <b>O21</b> <b>O25</b> <b>O31</b>	<b>O37</b> <b>O51</b> *
<b>3 Termination Type</b>	<b>HO</b> Horizontal Surface Mount	
<b>4 Shell Material &amp; Finish</b>	<b>N</b> Aluminum Shell, Electroless Nickel Plated <b>B</b> Aluminium Shell, Black Anodized	<b>CD</b> Aluminium Shell, Cadmium Plated <b>P</b> Stainless Steel Shell, Passivated
<b>5 Hardware</b>	<b>O0</b> None, Ø .092 Hole <b>O2</b> Jackscrews, STD Length, Hex (MMDP - STD) <b>O4</b> Jackscrews, Long Length, Hex <b>O6</b> Float Mount, Front Mounted <b>O8</b> Non-Removable	<b>O1</b> Fixed Jack-posts (MMDS - STD) <b>O3</b> Jackscrews, STD Length, Slotted <b>O5</b> Jackscrews, Long Length, Slotted <b>O7</b> Float Mount, Rear Mounted <b>YY</b> Non Standard Hardware
<b>6 Common Options</b>	<b>PA</b> Panel Mount Rear, O-Ring <b>HT</b> High Temp Epoxy	<b>PB</b> Panel Mount, Rear <b>RH</b> RoHS Compliant
<b>7 Mod Codes</b>	<b>M10</b> Keyed <b>M50</b> Space Grade Micro-D, SPT1	<b>M30</b> Ground Spring <b>M53</b> Space Grade Micro-D, SPT2
<b>8 Special Instructions</b>	<b>YYY</b> Describe anything that is not covered in standard options	

# METAL SHELL VERTICAL SMT MICRO-D (TYPE VV)

Omnetics **Metal Shell Vertical SMT Micro-D** Connectors provide designers with the flexibility needed to create compact system architectures. These connectors serve innovative military, medical, and aerospace technologies such as guidance systems, optics, and on-board equipment in land and sea vehicles and avionics. They are built to meet or exceed the rugged requirements of MIL-DTL-83513 and feature Omnetics' innovative one-piece flex pin design to protect the integrity of the system even under shock and vibration. These connectors are ready to provide reliable service at temperatures ranging from -55°C to 125°C, making them an excellent choice for the widest variety of applications.



## Electro-Mechanical Specifications

TYPE	PERFORMANCE
Durability	> 2000 Mating Cycles min
Temperature	-55°C to +125°C (200 °C w/HTE)
Current rating	3 Amps per contact per MIL-DTL-83513
Voltage Rating (DWV)	600 VAC RMS Sea Level
Insulation Resistance	5,000 Megohms @ 500 VDC
Shock	50 g's with no discontinuities > 1 microsecond
Vibration	20 g's with no discontinuities > 1 microsecond
Thermal Vacuum Outgassing	1.0% max TML, 0.1% max CVCM - NASA SP-R-0022
Contact Resistance	26 milliohms (65 mV) max @ 2.5 Amps per MIL-DTL-83513
Mating/Unmating Force	3 oz. (.85g) typical per contact

## Material Specifications

TYPE	PERFORMANCE
Contact	Copper Alloy Per MIL-DTL-83513
Contact Finish	Gold per ASTM B488, Type II, Class 1.27, Code C Over Nickel Underplate
Insulator	Thermoplastic per MIL-DTL-83513
Interfacial Seal	Silicone Elastomer per A-A-59588
Hardware	Stainless Steel, 300 Series, Passivated per SAE AMS-2700

## Shell Options

MATERIAL	FINISH
Aluminum 6061	Electroless Nickel per SAE-AMS-2404
Stainless Steel, 300 Series	Passivated per SAE-AMS-2700

# METAL SHELL VERTICAL SMT MICRO-D (TYPE VV)

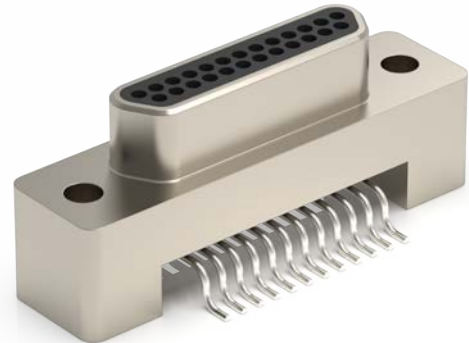

See page 158 for recommended board layout

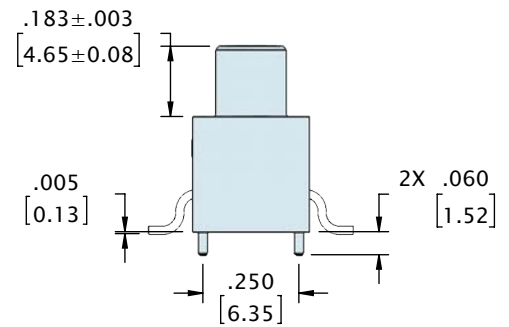
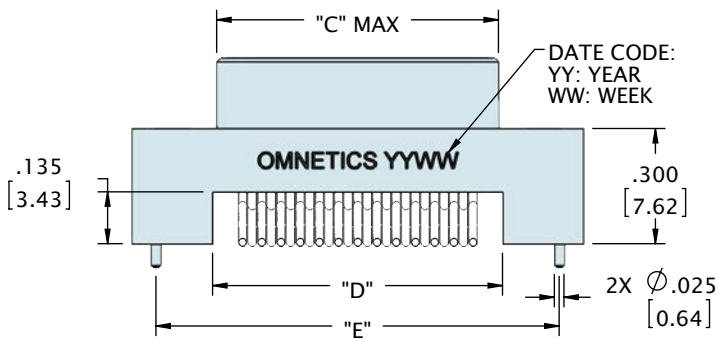
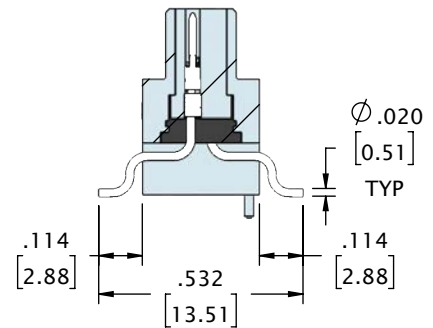
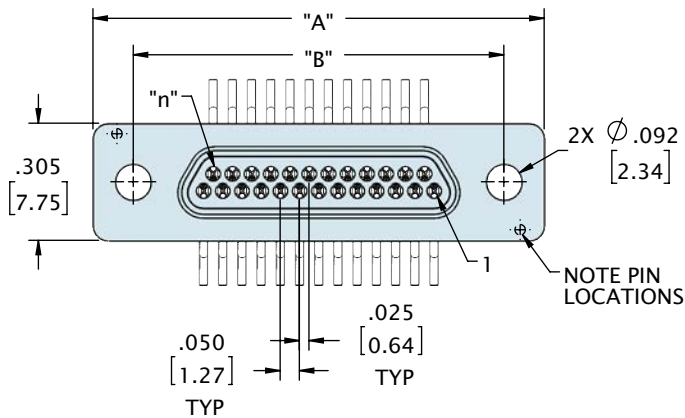

CONTACTS	ROWS	"A"	"B"	"C"	"D"	"E"
9	2	.775 [19.69]	.565 [14.35]	.334 [8.48]	.355 [9.02]	.650 [16.51]
15	2	.925 [23.50]	.715 [18.16]	.484 [12.29]	.505 [12.83]	.800 [20.32]
21	2	1.075 [27.31]	.865 [21.97]	.634 [16.10]	.655 [16.64]	.950 [24.13]
25	2	1.175 [29.85]	.965 [24.51]	.734 [18.64]	.755 [19.18]	1.050 [26.67]
31	2	1.325 [33.66]	1.115 [28.32]	.884 [22.45]	.905 [22.99]	1.200 [30.48]
37	2	1.475 [37.47]	1.265 [32.13]	1.034 [26.26]	1.055 [26.80]	1.350 [34.29]
51	2	1.825 [46.36]	1.615 [41.02]	1.384 [35.15]	1.405 [35.69]	1.700 [43.18]

DIMENSIONS IN [ ] ARE IN MILLIMETERS AND ARE FOR REFERENCE ONLY

# METAL SHELL VERTICAL SMT MICRO-D (TYPE VV)

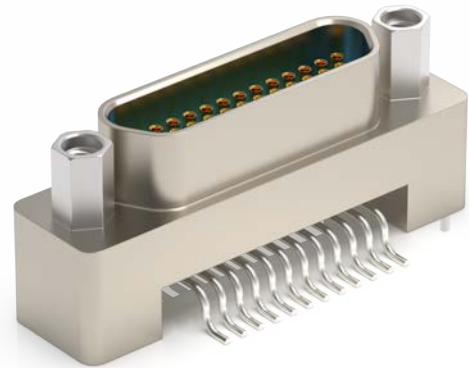

See page 158 for recommended board layout

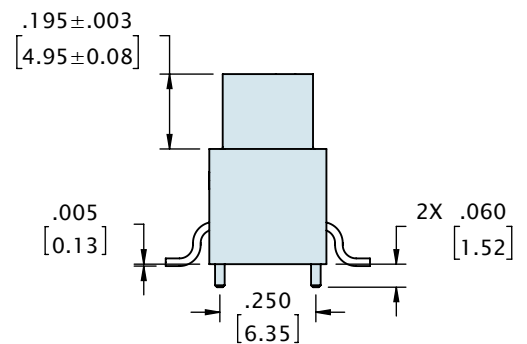
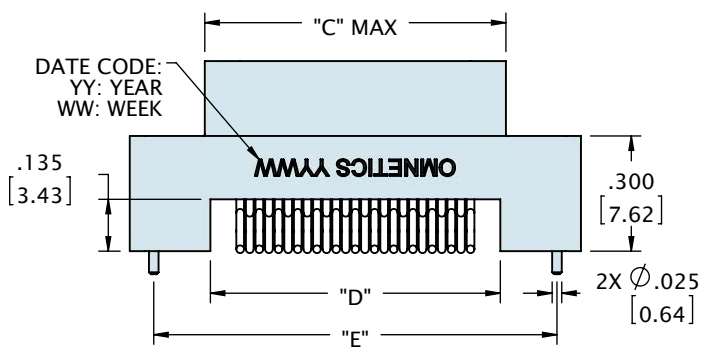
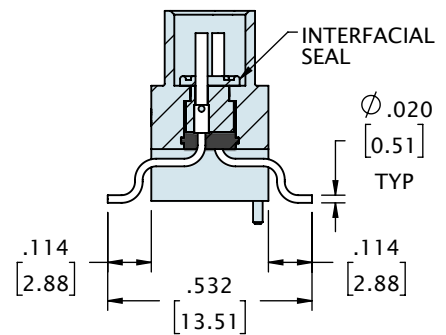
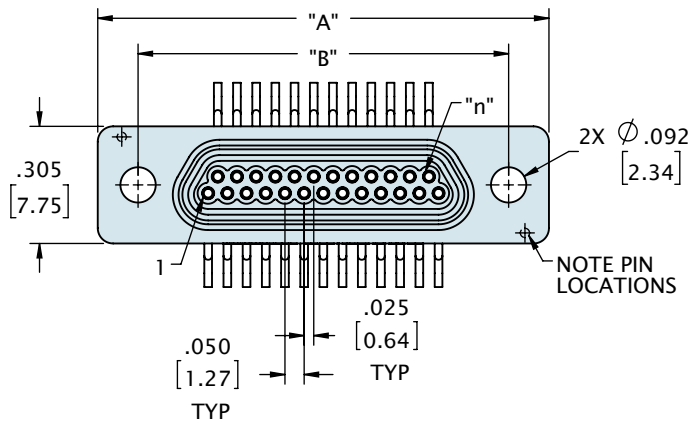

CONTACTS	ROWS	"A"	"B"	"C"	"D"	"E"
9	2	.775 [19.69]	.565 [14.35]	.400 [10.17]	.355 [9.02]	.650 [16.51]
15	2	.925 [23.50]	.715 [18.16]	.550 [13.98]	.505 [12.83]	.800 [20.32]
21	2	1.075 [27.31]	.865 [21.97]	.700 [17.79]	.655 [16.64]	.950 [24.13]
25	2	1.175 [29.85]	.965 [24.51]	.800 [20.33]	.755 [19.18]	1.050 [26.67]
31	2	1.325 [33.66]	1.115 [28.32]	.950 [24.14]	.905 [22.99]	1.200 [30.48]
37	2	1.475 [37.47]	1.265 [32.13]	1.100 [27.95]	1.055 [26.80]	1.350 [34.29]
51	2	1.825 [46.36]	1.615 [41.02]	1.450 [36.84]	1.405 [35.69]	1.700 [43.18]

DIMENSIONS IN [ ] ARE IN MILLIMETERS AND ARE FOR REFERENCE ONLY

## ORDERING GUIDE

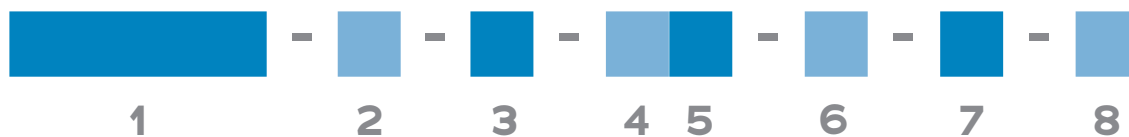

<b>1 Series</b>	<b>MMDP</b> Metal Micro-D Pin	<b>MMDS</b> Metal Micro-D Socket
<b>2 Number of Contacts</b>	<b>O09</b> <b>O15</b> <b>O21</b> <b>O25</b> <b>O31</b> <b>O37</b> <b>O51</b> *	
<b>3 Termination Type</b>	<b>VV</b> Vertical Surface Mount	
<b>4 Shell Material &amp; Finish</b>	<b>N</b> Aluminum Shell, Electroless Nickel Plated <b>B</b> Aluminium Shell, Black Anodized	<b>CD</b> Aluminium Shell, Cadmium Plated <b>P</b> Stainless Steel Shell, Passivated
<b>5 Hardware</b>	<b>OO</b> None, Ø .092 Hole <b>YY</b> Non Standard Hardware	<b>O1</b> Fixed Jack-posts (STD)
<b>6 Common Options</b>	<b>PA</b> Panel Mount Rear, O-Ring <b>HT</b> High Temp Epoxy	<b>PB</b> Panel Mount, Rear <b>RH</b> RoHS Compliant
<b>7 Mod Codes</b>	<b>M10</b> Keyed <b>M50</b> Space Grade Micro-D, SPT1	<b>M30</b> Ground Spring <b>M53</b> Space Grade Micro-D, SPT2
<b>8 Special Instructions</b>	<b>YYY</b> Describe anything that is not covered in standard options	

# METAL SHELL MICRO-D CARD EDGE SURFACE MOUNT (TYPE CO)

Omnetics **Metal Shell Micro-D Card Edge Surface Mount** Connectors are engineered for applications with tight architectures, providing high signal integrity while preserving space on the board. These connectors serve innovative military and civilian technologies such as navigation and communications systems and computing devices. They are built to meet or exceed the rugged requirements of MIL-DTL-83513 and feature Omnetics' one-piece flex pin design to protect the integrity of the system even under shock and vibration. These connectors are rated to three amps per contact.

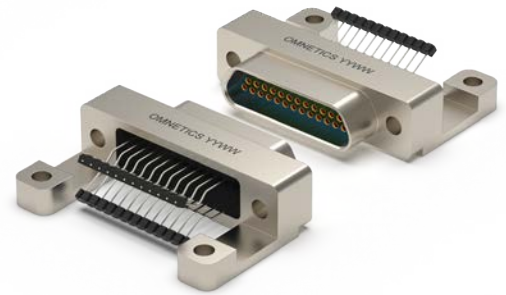

## Electro-Mechanical Specifications

TYPE	PERFORMANCE
Durability	> 2000 Mating Cycles min
Temperature	-55°C to +125°C (200 °C w/HTE)
Current rating	3 Amps per contact per MIL-DTL-83513
Voltage Rating (DWV)	600 VAC RMS Sea Level
Insulation Resistance	5,000 Megohms @ 500 VDC
Shock	50 g's with no discontinuities > 1 microsecond
Vibration	20 g's with no discontinuities > 1 microsecond
Thermal Vacuum Outgassing	1.0% max TML, 0.1% max CVCM - NASA SP-R-0022
Contact Resistance	26 milliohms (65 mV) max @ 2.5 Amps per MIL-DTL-83513
Mating/Unmating Force	3 oz. (.85g) typical per contact

## Material Specifications

TYPE	PERFORMANCE
Contact	Copper Alloy Per MIL-DTL-83513
Contact Finish	Gold per ASTM B488, Type II, Class 1.27, Code C Over Nickel Underplate
Insulator	Thermoplastic per MIL-DTL-83513
Interfacial Seal	Silicone Elastomer per A-A-59588
Hardware	Stainless Steel, 300 Series, Passivated per SAE AMS-2700

## Shell Options

MATERIAL	FINISH
Aluminum 6061	Electroless Nickel per SAE-AMS-2404
Stainless Steel, 300 Series	Passivated per SAE-AMS-2700

# METAL SHELL MICRO-D CARD EDGE SURFACE MOUNT (TYPE CO)



See page 159 for recommended board layout

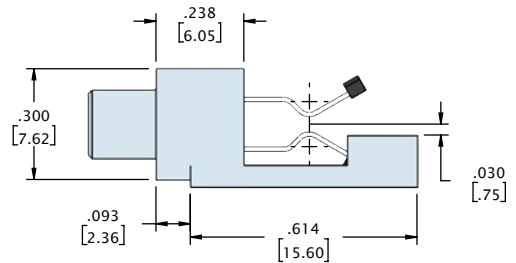
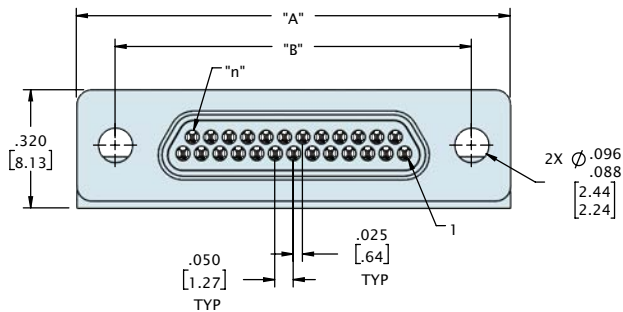
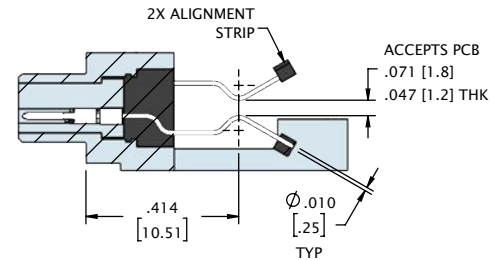
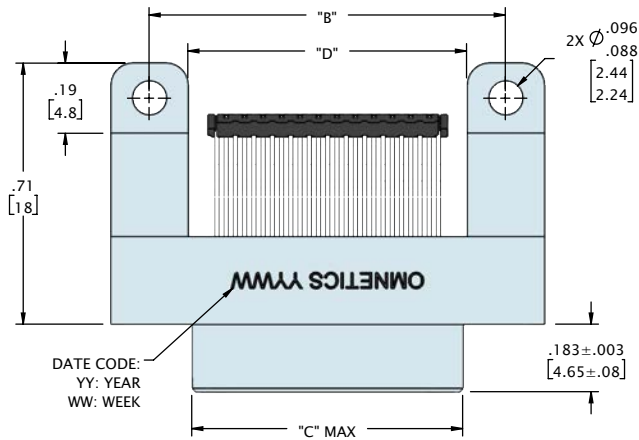

CONTACTS	ROWS	"A"	"B"	"C"	"D"
9	2	.775 [19.69]	.565 [14.35]	.334 [8.48]	.355 [9.02]
15	2	.925 [23.50]	.715 [18.16]	.484 [12.29]	.505 [12.83]
21	2	1.075 [27.31]	.865 [21.97]	.634 [16.10]	.655 [16.64]
25	2	1.175 [29.85]	.965 [24.51]	.734 [18.64]	.755 [19.18]
31	2	1.325 [33.66]	1.115 [28.32]	.884 [22.45]	.905 [22.99]
37	2	1.475 [37.47]	1.265 [32.13]	1.034 [26.26]	1.055 [26.80]
51	2	1.825 [46.36]	1.615 [41.02]	1.384 [35.15]	1.405 [35.69]

DIMENSIONS IN [ ] ARE IN MILLIMETERS AND ARE FOR REFERENCE ONLY

# METAL SHELL MICRO-D CARD EDGE SURFACE MOUNT (TYPE CO)

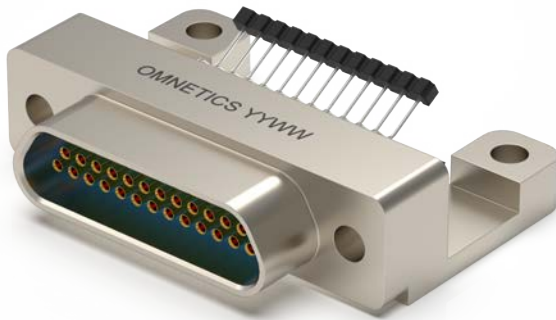

See page 159 for recommended board layout

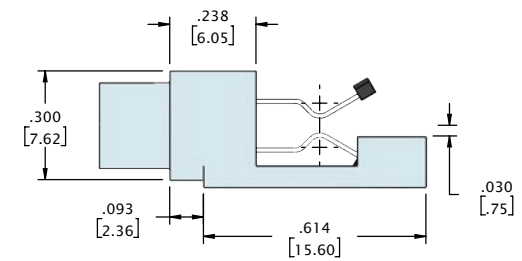
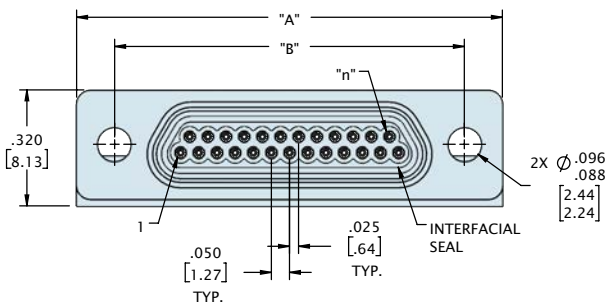
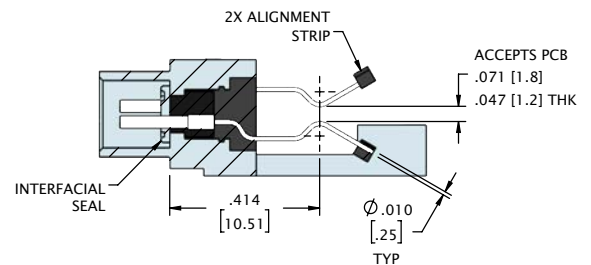
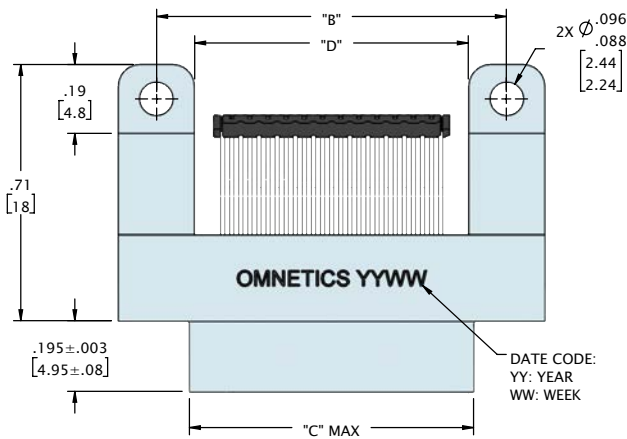

CONTACTS	ROWS	"A"	"B"	"C"	"D"
9	2	.775 [19.69]	.565 [14.35]	.400 [10.17]	.355 [9.02]
15	2	.925 [23.50]	.715 [18.16]	.550 [13.98]	.505 [12.83]
21	2	1.075 [27.31]	.865 [21.97]	.700 [17.79]	.655 [16.64]
25	2	1.175 [29.85]	.965 [24.51]	.800 [20.33]	.755 [19.18]
31	2	1.325 [33.66]	1.115 [28.32]	.950 [24.14]	.905 [22.99]
37	2	1.475 [37.47]	1.265 [32.13]	1.100 [27.95]	1.055 [26.80]
51	2	1.825 [46.36]	1.615 [41.02]	1.450 [36.84]	1.405 [35.69]

DIMENSIONS IN [ ] ARE IN MILLIMETERS AND ARE FOR REFERENCE ONLY



## ORDERING GUIDE

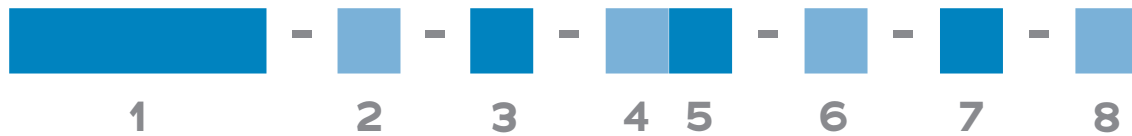

<b>1 Series</b>	<b>MMDP</b> Metal Micro-D Pin	<b>MMDS</b> Metal Micro-D Socket
<b>2 Number of Contacts</b>	<b>009</b> <b>015</b> <b>021</b> <b>025</b> <b>031</b> <b>037</b> <b>051*</b>	
	* Use <b>512</b> for Two Rows <b>051</b>	
<b>3 Termination Type</b>	<b>CO</b> Card Edge Surface Mount	
<b>4 Shell Material &amp; Finish</b>	<b>N</b> Aluminum Shell, Electroless Nickel Plated <b>B</b> Aluminium Shell, Black Anodized	<b>CD</b> Aluminium Shell, Cadmium Plated <b>P</b> Stainless Steel Shell, Passivated
<b>5 Hardware</b>	<b>00</b> None, Ø .092 Hole <b>02</b> Jackscrews, STD Length, Hex (MMDP - STD) <b>04</b> Jackscrews, Long Length, Hex <b>YY</b> Non Standard Hardware	<b>01</b> Fixed Jack-posts (MMDS - STD) <b>03</b> Jackscrews, STD Length, Slotted <b>05</b> Jackscrews, Long Length, Slotted
<b>6 Common Options</b>	<b>PA</b> Panel Mount Rear, O-Ring <b>HT</b> High Temp Epoxy	<b>PB</b> Panel Mount, Rear <b>RH</b> RoHS Compliant
<b>7 Mod Codes</b>	<b>M10</b> Keyed <b>M50</b> Space Grade Micro-D, SPT1	<b>M30</b> Ground Spring <b>M53</b> Space Grade Micro-D, SPT2
<b>8 Special Instructions</b>	<b>YYY</b> Describe anything that is not covered in standard options	

# METAL SHELL MICRO-D FLEX TAIL (TYPE FF)

Omnetics **Metal Shell Micro-D Flex Tail** Connectors are ideal for small devices, robotics, and unmanned systems. They serve emerging technologies in the military, medical, and aeronautics worlds. They are built to meet or exceed the rugged requirements of MIL-DTL-83513 and feature Omnetics' innovative one-piece flex pin design to protect the integrity of the system even under shock and vibration. The gold-plated flex pins are built to withstand more than 2,000 mating cycles, making them a good choice for hand-on applications that see significant use in the field.

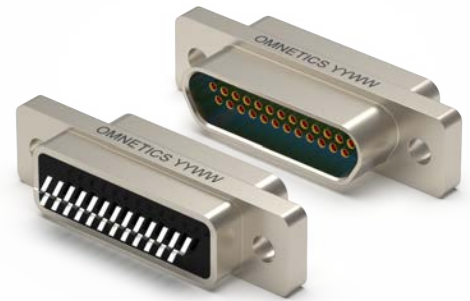

## Electro-Mechanical Specifications

TYPE	PERFORMANCE
Durability	> 2000 Mating Cycles min
Temperature	-55°C to +125°C (200 °C w/HTE)
Current rating	3 Amps per contact per MIL-DTL-83513
Voltage Rating (DWV)	600 VAC RMS Sea Level
Insulation Resistance	5,000 Megohms @ 500 VDC
Shock	50 g's with no discontinuities > 1 microsecond
Vibration	20 g's with no discontinuities > 1 microsecond
Thermal Vacuum Outgassing	1.0% max TML, 0.1% max CVCM - NASA SP-R-0022
Contact Resistance	26 milliohms (65 mV) max @ 2.5 Amps per MIL-DTL-83513
Mating/Unmating Force	3 oz. (.85g) typical per contact

## Material Specifications

TYPE	PERFORMANCE
Contact	Copper Alloy Per MIL-DTL-83513
Contact Finish	Gold per ASTM B488, Type II, Class 1.27, Code C Over Nickel Underplate
Insulator	Thermoplastic per MIL-DTL-83513
Interfacial Seal	Silicone Elastomer per A-A-59588
Hardware	Stainless Steel, 300 Series, Passivated per SAE AMS-2700

## Shell Options

MATERIAL	FINISH
Aluminum 6061	Electroless Nickel per SAE-AMS-2404
Stainless Steel, 300 Series	Passivated per SAE-AMS-2700

# METAL SHELL MICRO-D FLEX TAIL (TYPE FF)

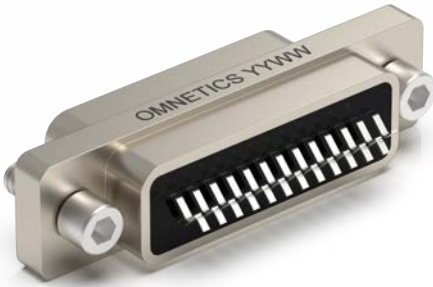

See page 159 for recommended board layout

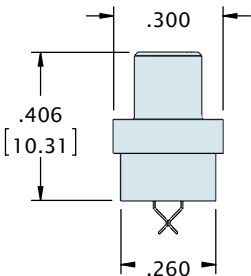
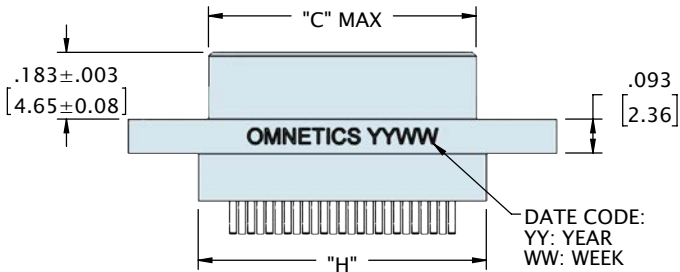
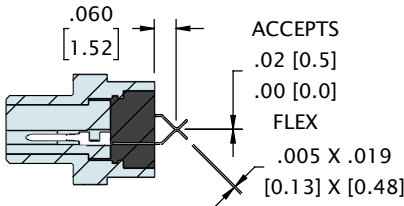
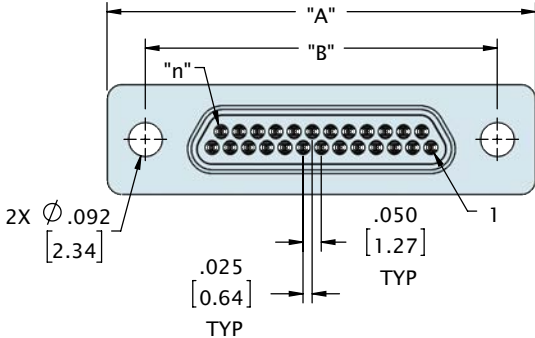

CONTACTS	ROWS	"A"	"B"	"C"	"D"
9	2	.775 [19.69]	.565 [14.35]	.334 [8.48]	.390 [9.91]
15	2	.925 [23.50]	.715 [18.16]	.484 [12.29]	.540 [13.72]
21	2	1.075 [27.31]	.865 [21.97]	.634 [16.10]	.690 [17.53]
25	2	1.175 [29.85]	.965 [24.51]	.734 [18.64]	.790 [20.07]
31	2	1.325 [33.66]	1.115 [28.32]	.884 [22.45]	.940 [23.88]
37	2	1.475 [37.47]	1.265 [32.13]	1.034 [26.26]	1.090 [27.69]
51	2	1.825 [46.36]	1.615 [41.02]	1.384 [35.15]	1.440 [36.58]

DIMENSIONS IN [ ] ARE IN MILLIMETERS AND ARE FOR REFERENCE ONLY

# METAL SHELL MICRO-D FLEX TAIL (TYPE FF)

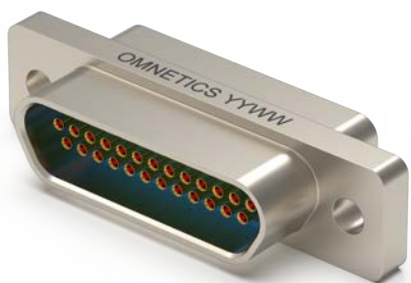

See page 159 for recommended board layout

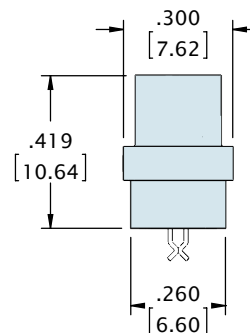
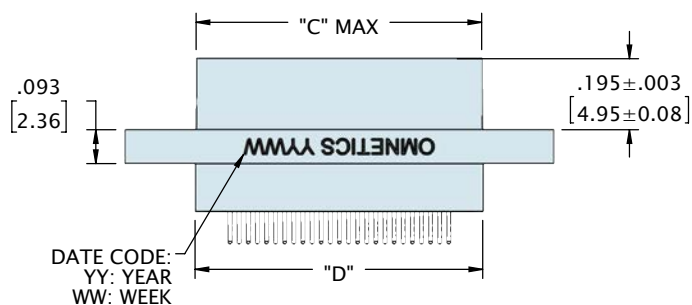
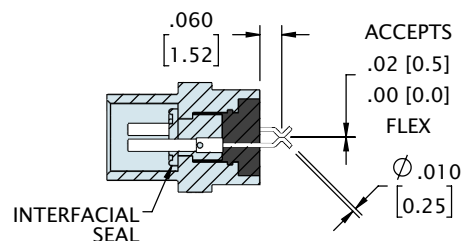
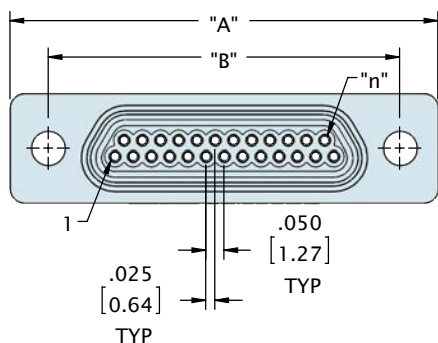

CONTACTS	ROWS	"A"	"B"	"C"	"D"
9	2	.775 [19.69]	.565 [14.35]	.334 [8.48]	.390 [9.91]
15	2	.925 [23.50]	.715 [18.16]	.484 [12.29]	.540 [13.72]
21	2	1.075 [27.31]	.865 [21.97]	.634 [16.10]	.690 [17.53]
25	2	1.175 [29.85]	.965 [24.51]	.734 [18.64]	.790 [20.07]
31	2	1.325 [33.66]	1.115 [28.32]	.884 [22.45]	.940 [23.88]
37	2	1.475 [37.47]	1.265 [32.13]	1.034 [26.26]	1.090 [27.69]
51	2	1.825 [46.36]	1.615 [41.02]	1.384 [35.15]	1.440 [36.58]

DIMENSIONS IN [ ] ARE IN MILLIMETERS AND ARE FOR REFERENCE ONLY

## ORDERING GUIDE

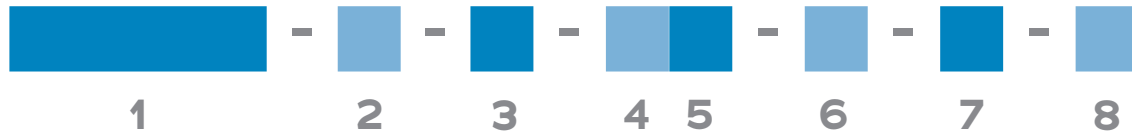

<b>1 Series</b>	<b>MMDP</b> Metal Micro-D Pin	<b>MMDS</b> Metal Micro-D Socket
<b>2 Number of Contacts</b>	<b>009</b> <b>015</b> <b>021</b> <b>025</b> <b>031</b> <b>037</b> <b>051*</b>	
	* Use <b>512</b> for Two Rows <b>051</b>	
<b>3 Termination Type</b>	<b>FF</b> Flex Tail	
<b>4 Shell Material &amp; Finish</b>	<b>N</b> Aluminum Shell, Electroless Nickel Plated <b>B</b> Aluminium Shell, Black Anodized	<b>CD</b> Aluminium Shell, Cadmium Plated <b>P</b> Stainless Steel Shell, Passivated
<b>5 Hardware</b>	<b>00</b> None, Ø .092 Hole <b>02</b> Jackscrews, STD Length, Hex (MMDP - STD) <b>04</b> Jackscrews, Long Length, Hex <b>06</b> Float Mount, Front Mounted	<b>01</b> Fixed Jack-posts (MMDS - STD) <b>03</b> Jackscrews, STD Length, Slotted <b>05</b> Jackscrews, Long Length, Slotted <b>YY</b> Non Standard Hardware
<b>6 Common Options</b>	<b>PA</b> Panel Mount Rear, O-Ring <b>HT</b> High Temp Epoxy	<b>PB</b> Panel Mount, Rear <b>RH</b> RoHS Compliant
<b>7 Mod Codes</b>	<b>M10</b> Keyed <b>M50</b> Space Grade Micro-D, SPT1	<b>M30</b> Ground Spring <b>M53</b> Space Grade Micro-D, SPT2
<b>8 Special Instructions</b>	<b>YYY</b> Describe anything that is not covered in standard options	

# METAL SHELL MICRO-D STRAIGHT THRU-HOLE (TYPE DD)

Omnetics **Metal Shell Micro-D Straight Thru-Hole** Connectors provide high performance in rugged environments. They serve critical technologies in military, medical, and aeronautics systems. They meet or exceed the rugged requirements of MIL-DTL-83513 and feature Omnetics' innovative one-piece flex pin design to protect the integrity of the system even under shock and vibration. The gold-plated flex pins are built to withstand more than 2,000 mating cycles. They are ideal for designs that require maximum performance in the smallest and tightest systems.

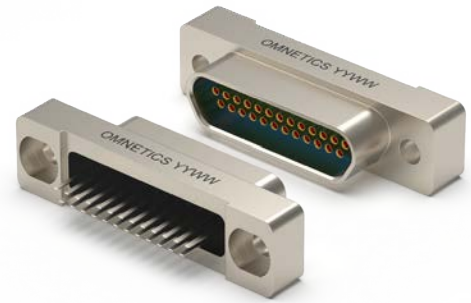

## Electro-Mechanical Specifications

TYPE	PERFORMANCE
Durability	> 2000 Mating Cycles min
Temperature	-55°C to +125°C (200 °C w/HTE)
Current rating	3 Amps per contact per MIL-DTL-83513
Voltage Rating (DWV)	600 VAC RMS Sea Level
Insulation Resistance	5,000 Megohms @ 500 VDC
Shock	50 g's with no discontinuities > 1 microsecond
Vibration	20 g's with no discontinuities > 1 microsecond
Thermal Vacuum Outgassing	1.0% max TML, 0.1% max CVCM - NASA SP-R-0022
Contact Resistance	26 milliohms (65 mV) max @ 2.5 Amps per MIL-DTL-83513
Mating/Unmating Force	3 oz. (.85g) typical per contact

## Material Specifications

TYPE	PERFORMANCE
Contact	Copper Alloy Per MIL-DTL-83513
Contact Finish	Gold per ASTM B488, Type II, Class 1.27, Code C Over Nickel Underplate
Insulator	Thermoplastic per MIL-DTL-83513
Interfacial Seal	Silicone Elastomer per A-A-59588
Hardware	Stainless Steel, 300 Series, Passivated per SAE AMS-2700

## Shell Options

MATERIAL	FINISH
Aluminum 6061	Electroless Nickel per SAE-AMS-2404
Stainless Steel, 300 Series	Passivated per SAE-AMS-2700

# METAL SHELL MICRO-D STRAIGHT THRU-HOLE (TYPE DD)



See page 160 for recommended board layout

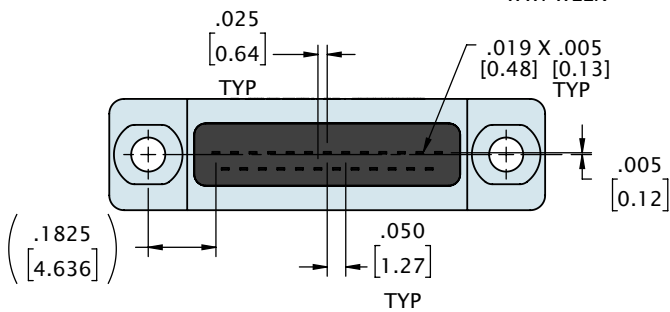
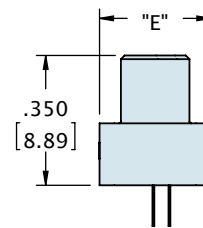
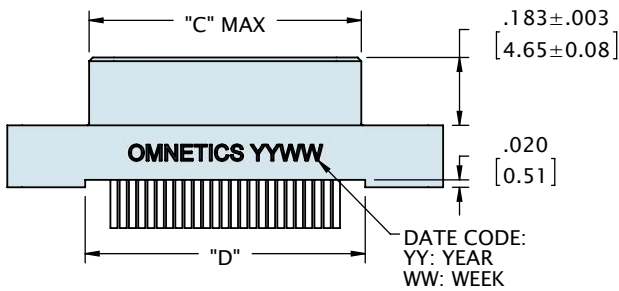
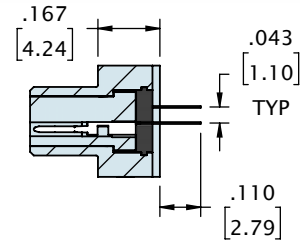
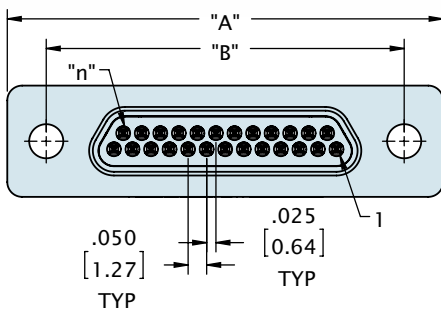

CONTACTS	ROWS	"A"	"B"	"C"	"D"	"E"
9	2	.775 [19.69]	.565 [14.35]	.334 [8.48]	.355 [9.02]	.300 [7.62]
15	2	.925 [23.50]	.715 [18.16]	.484 [12.29]	.505 [12.83]	.300 [7.62]
21	2	1.075 [27.31]	.865 [21.97]	.634 [16.10]	.655 [16.64]	.300 [7.62]
25	2	1.175 [29.85]	.965 [24.51]	.734 [18.64]	.755 [19.18]	.300 [7.62]
31	2	1.325 [33.66]	1.115 [28.32]	.884 [22.45]	.905 [22.99]	.300 [7.62]
37	2	1.475 [37.47]	1.265 [32.13]	1.034 [26.26]	1.055 [26.80]	.300 [7.62]
51	2	1.825 [46.36]	1.615 [41.02]	1.384 [35.15]	1.405 [35.69]	.300 [7.62]
51	3	1.425 [36.20]	1.215 [30.86]	.984 [24.99]	1.005 [25.53]	.341 [8.66]
69	3	1.725 [43.82]	1.515 [38.48]	1.284 [32.61]	1.305 [33.15]	.341 [8.66]
100	4	2.160 [54.86]	1.800 [45.72]	1.384 [35.15]	1.440 [36.58]	.386 [9.80]

DIMENSIONS IN [ ] ARE IN MILLIMETERS AND ARE FOR REFERENCE ONLY

# METAL SHELL MICRO-D STRAIGHT THRU-HOLE (TYPE DD)

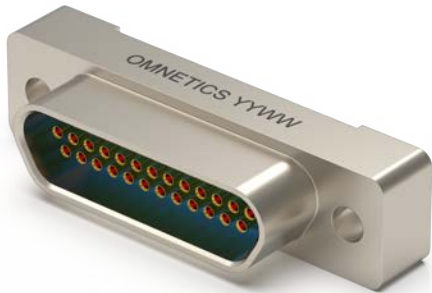

See page 160 for recommended board layout

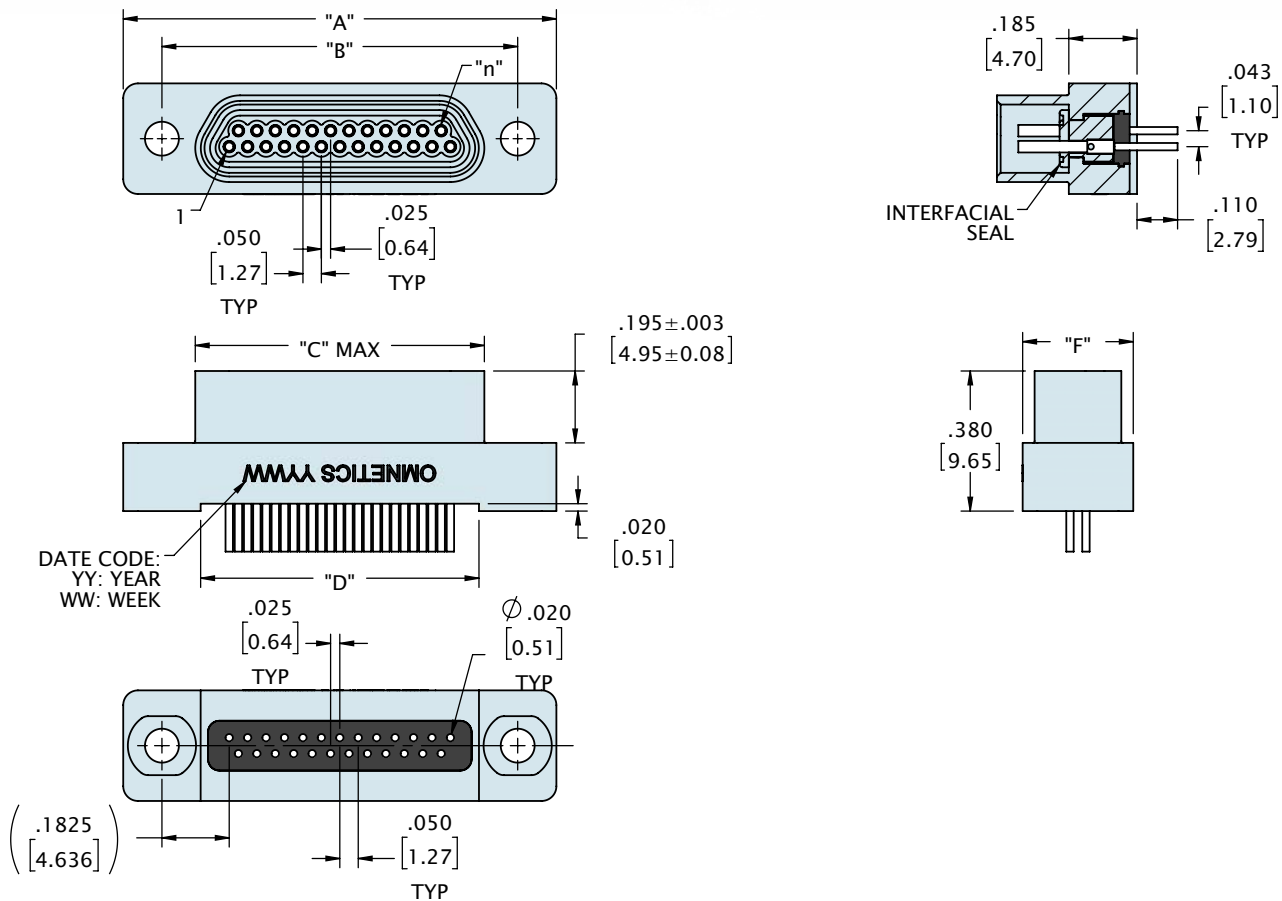

CONTACTS	ROWS	"A"	"B"	"C"	"D"	"E"
9	2	.775 [19.69]	.565 [14.35]	.400 [10.17]	.355 [9.02]	.300 [7.62]
15	2	.925 [23.50]	.715 [18.16]	.550 [13.98]	.505 [12.83]	.300 [7.62]
21	2	1.075 [27.31]	.865 [21.97]	.700 [17.79]	.655 [16.64]	.300 [7.62]
25	2	1.175 [29.85]	.965 [24.51]	.800 [20.33]	.755 [19.18]	.300 [7.62]
31	2	1.325 [33.66]	1.115 [28.32]	.950 [24.14]	.905 [22.99]	.300 [7.62]
37	2	1.475 [37.47]	1.265 [32.13]	1.100 [27.95]	1.055 [26.80]	.300 [7.62]
51	2	1.825 [46.36]	1.615 [41.02]	1.450 [36.84]	1.405 [35.69]	.300 [7.62]
51	3	1.425 [36.20]	1.215 [30.86]	1.050 [26.67]	1.005 [25.53]	.343 [8.71]
69	3	1.725 [43.82]	1.515 [38.48]	1.350 [34.29]	1.305 [33.15]	.343 [8.71]
100	4	2.160 [54.86]	1.800 [45.72]	1.450 [36.83]	1.440 [36.58]	.386 [9.80]

DIMENSIONS IN [ ] ARE IN MILLIMETERS AND ARE FOR REFERENCE ONLY



## ORDERING GUIDE

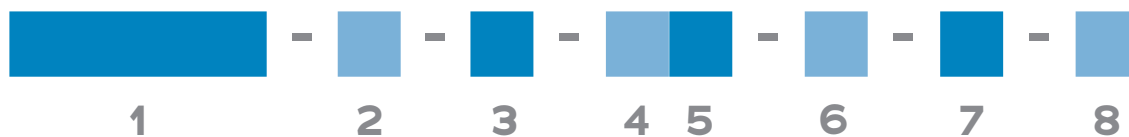

<b>1 Series</b>	<b>MMDP</b> Metal Micro-D Pin	<b>MMDS</b> Metal Micro-D Socket
<b>2 Number of Contacts</b>	<b>009</b> <b>015</b> <b>021</b> <b>025</b> <b>031</b> <b>037</b> <b>051*</b> <b>069</b> <b>100</b>	
	* Use <b>512</b> for Two Rows <b>051</b> and <b>513</b> for Three Rows <b>051</b>	
<b>3 Termination Type</b>	<b>DD</b> Straight Thru-Hole	
<b>4 Shell Material &amp; Finish</b>	<b>N</b> Aluminum Shell, Electroless Nickel Plated <b>B</b> Aluminium Shell, Black Anodized	<b>CD</b> Aluminium Shell, Cadmium Plated <b>P</b> Stainless Steel Shell, Passivated
<b>5 Hardware</b>	<b>00</b> None, Ø .092 Hole <b>02</b> Jackscrews, STD Length, Hex (MMDP - STD) <b>04</b> Jackscrews, Long Length, Hex <b>06</b> Float Mount, Front Mounted	<b>01</b> Fixed Jack-posts (MMDS - STD) <b>03</b> Jackscrews, STD Length, Slotted <b>05</b> Jackscrews, Long Length, Slotted <b>YY</b> Non Standard Hardware
<b>6 Common Options</b>	<b>PA</b> Panel Mount Rear, O-Ring <b>IBS</b> Integrated Backshell <b>RH</b> RoHS Compliant	<b>PB</b> Panel Mount, Rear <b>HT</b> High Temp Epoxy
<b>7 Mod Codes</b>	<b>M10</b> Keyed <b>M50</b> Space Grade Micro-D, SPT1	<b>M30</b> Ground Spring <b>M53</b> Space Grade Micro-D, SPT2
<b>8 Special Instructions</b>	<b>YYY</b> Describe anything that is not covered in standard options	

# METAL SHELL MICRO-D RIGHT ANGLE THRU-HOLE (TYPE H2)

Omnetics **Metal Shell Micro-D Right Angle Thru-Hole** Connectors enable designers to fit powerful connectivity into compressed electronic systems. They serve critical technologies in the military, medical, and aeronautics industries. These high-reliability connectors meet or exceed the rugged requirements of MIL-DTL-83513. They feature Omnetics' innovative one-piece flex pin design to protect the integrity of system that must provide exceptional performance even under conditions that include shock and vibration. The gold-plated flex pins are built to withstand more than 2,000 mating cycles. They play a key role in emerging product design for the most demanding environments.

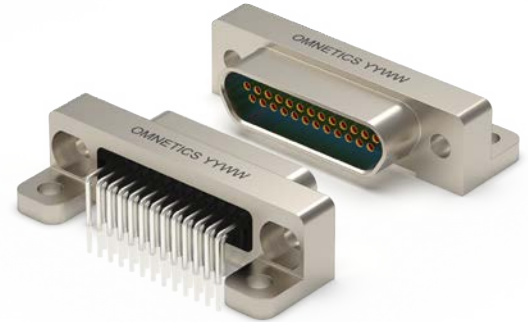

## Electro-Mechanical Specifications

TYPE	PERFORMANCE
Durability	> 2000 Mating Cycles min
Temperature	-55°C to +125°C (200 °C w/HTE)
Current rating	3 Amps per contact per MIL-DTL-83513
Voltage Rating (DWV)	600 VAC RMS Sea Level
Insulation Resistance	5,000 Megohms @ 500 VDC
Shock	50 g's with no discontinuities > 1 microsecond
Vibration	20 g's with no discontinuities > 1 microsecond
Thermal Vacuum Outgassing	1.0% max TML, 0.1% max CVCM - NASA SP-R-0022
Contact Resistance	26 milliohms (65 mV) max @ 2.5 Amps per MIL-DTL-83513
Mating/Unmating Force	3 oz. (.85g) typical per contact

## Material Specifications

TYPE	PERFORMANCE
Contact	Copper Alloy Per MIL-DTL-83513
Contact Finish	Gold per ASTM B488, Type II, Class 1.27, Code C Over Nickel Underplate
Insulator	Thermoplastic per MIL-DTL-83513
Interfacial Seal	Silicone Elastomer per A-A-59588
Hardware	Stainless Steel, 300 Series, Passivated per SAE AMS-2700

## Shell Options

MATERIAL	FINISH
Aluminum 6061	Electroless Nickel per SAE-AMS-2404
Stainless Steel, 300 Series	Passivated per SAE-AMS-2700

# METAL SHELL MICRO-D RIGHT ANGLE THRU-HOLE (TYPE H2)

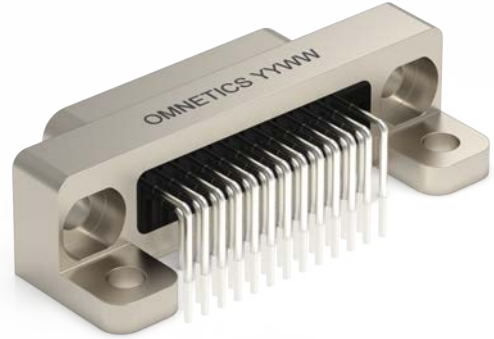

See page 161 for recommended board layout

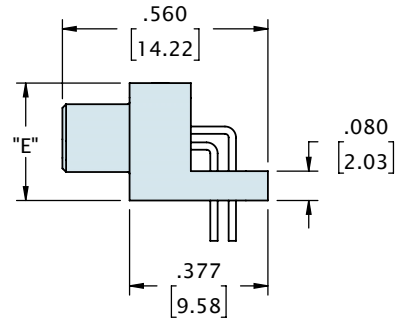
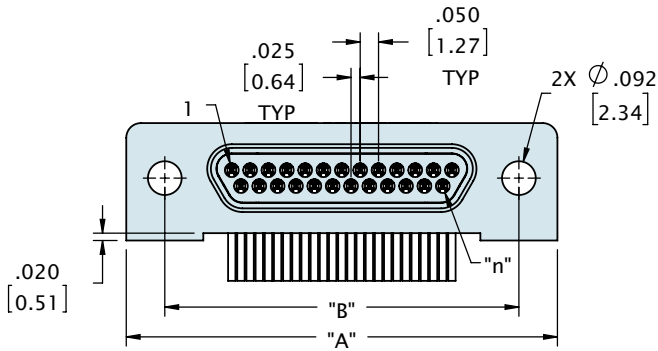
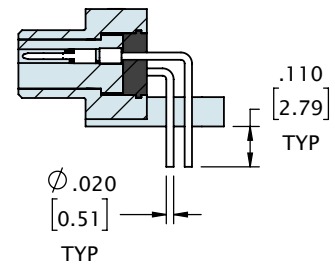
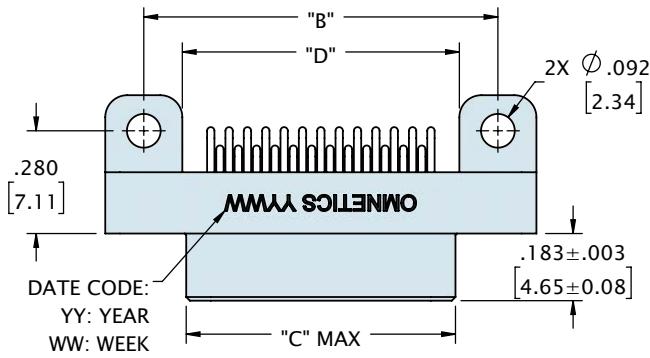

CONTACTS	ROWS	"A"	"B"	"C"	"D"	"E"
9	2	.775 [19.69]	.565 [14.35]	.334 [8.48]	.355 [9.02]	.320 [8.13]
15	2	.925 [23.50]	.715 [18.16]	.484 [12.29]	.505 [12.83]	.320 [8.13]
21	2	1.075 [27.31]	.865 [21.97]	.634 [16.10]	.655 [16.64]	.320 [8.13]
25	2	1.175 [29.85]	.965 [24.51]	.734 [18.64]	.755 [19.18]	.320 [8.13]
31	2	1.325 [33.66]	1.115 [28.32]	.884 [22.45]	.905 [22.99]	.320 [8.13]
37	2	1.475 [37.47]	1.265 [32.13]	1.034 [26.26]	1.055 [26.80]	.320 [8.13]
51	2	1.825 [46.36]	1.615 [41.02]	1.384 [35.15]	1.405 [35.69]	.320 [8.13]
51	3	1.425 [36.20]	1.215 [30.86]	.984 [24.99]	1.005 [25.53]	.361 [9.17]
69	3	1.725 [43.82]	1.515 [38.48]	1.284 [32.61]	1.305 [33.15]	.361 [9.17]
100	4	2.160 [54.86]	1.800 [45.72]	1.384 [35.15]	1.440 [36.58]	.406 [10.31]

DIMENSIONS IN [ ] ARE IN MILLIMETERS AND ARE FOR REFERENCE ONLY

# METAL SHELL MICRO-D RIGHT ANGLE THRU-HOLE (TYPE H2)

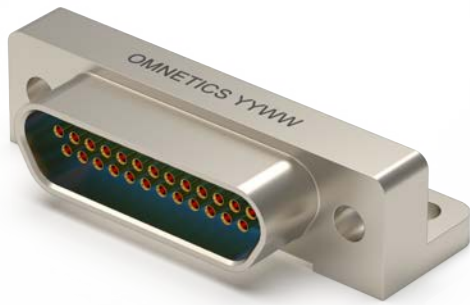

See page 161 for recommended board layout

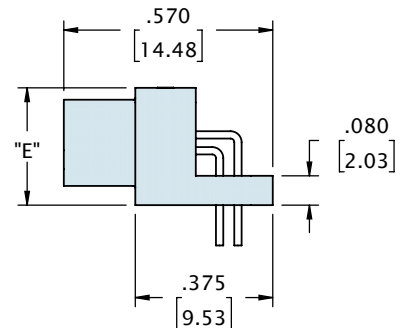
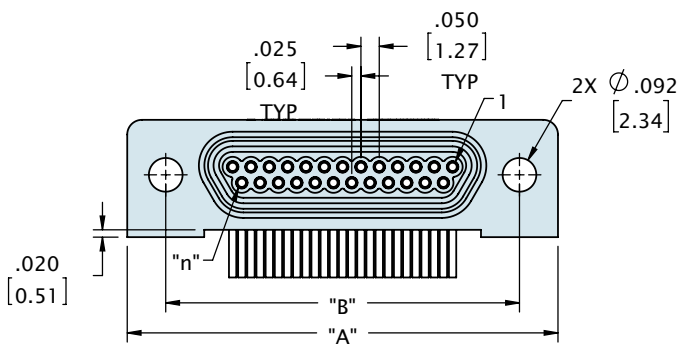
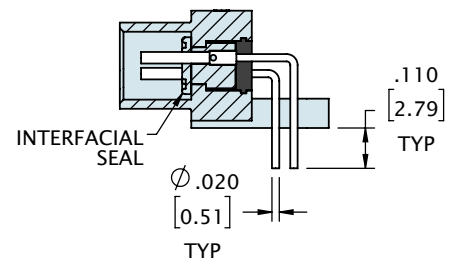
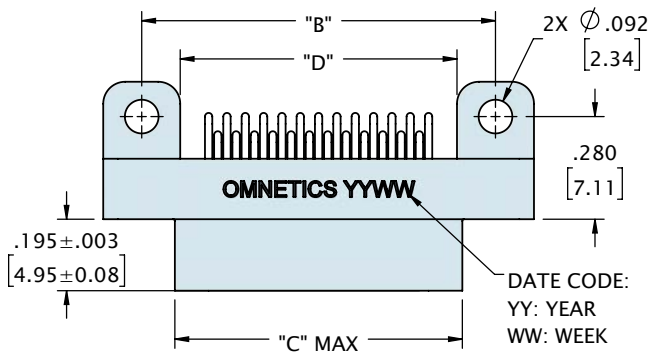

CONTACTS	ROWS	"A"	"B"	"C"	"D"	"E"
9	2	.775 [19.69]	.565 [14.35]	.400 [10.17]	.355 [9.02]	.320 [8.13]
15	2	.925 [23.50]	.715 [18.16]	.550 [13.98]	.505 [12.83]	.320 [8.13]
21	2	1.075 [27.31]	.865 [21.97]	.700 [17.79]	.655 [16.64]	.320 [8.13]
25	2	1.175 [29.85]	.965 [24.51]	.800 [20.33]	.755 [19.18]	.320 [8.13]
31	2	1.325 [33.66]	1.115 [28.32]	.950 [24.14]	.905 [22.99]	.320 [8.13]
37	2	1.475 [37.47]	1.265 [32.13]	1.100 [27.95]	1.055 [26.80]	.320 [8.13]
51	2	1.825 [46.36]	1.615 [41.02]	1.450 [36.84]	1.405 [35.69]	.320 [8.13]
51	3	1.425 [36.20]	1.215 [30.86]	1.050 [26.67]	1.005 [25.53]	.361 [9.17]
69	3	1.725 [43.82]	1.515 [38.48]	1.350 [34.29]	1.305 [33.15]	.361 [9.17]
100	4	2.160 [54.86]	1.800 [45.72]	1.450 [36.83]	1.440 [36.58]	.406 [10.31]

DIMENSIONS IN [ ] ARE IN MILLIMETERS AND ARE FOR REFERENCE ONLY

## ORDERING GUIDE

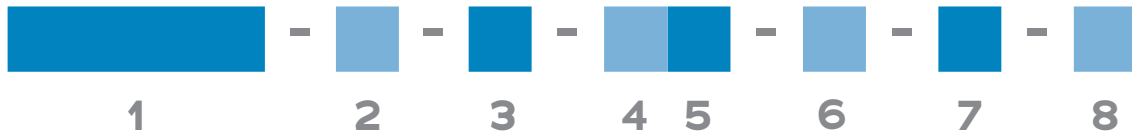

<b>1 Series</b>	<b>MMDP</b> Metal Micro-D Pin	<b>MMDS</b> Metal Micro-D Socket
<b>2 Number of Contacts</b>	<b>009</b> <b>015</b> <b>021</b> <b>025</b> <b>031</b> <b>037</b> <b>051*</b> <b>069</b> <b>100</b>	
* Use <b>512</b> for Two Rows <b>051</b> and <b>513</b> for Three Rows <b>051</b>		
<b>3 Termination Type</b>	<b>H2</b> Right Angle Thru-Hole	
<b>4 Shell Material &amp; Finish</b>	<b>N</b> Aluminum Shell, Electroless Nickel Plated <b>B</b> Aluminium Shell, Black Anodized	<b>CD</b> Aluminium Shell, Cadmium Plated <b>P</b> Stainless Steel Shell, Passivated
<b>5 Hardware</b>	<b>00</b> None, Ø .092 Hole <b>002</b> Jackscrews, STD Length, Hex (MMDP - STD) <b>04</b> Jackscrews, Long Length, Hex <b>YY</b> Non Standard Hardware	<b>01</b> Fixed Jack-posts (MMDS - STD) <b>03</b> Jackscrews, STD Length, Slotted <b>05</b> Jackscrews, Long Length, Slotted
<b>6 Common Options</b>	<b>PA</b> Panel Mount Rear, O-Ring <b>HT</b> High Temp Epoxy	<b>PB</b> Panel Mount, Rear <b>RH</b> RoHS Compliant
<b>7 Mod Codes</b>	<b>M10</b> Keyed <b>M50</b> Space Grade Micro-D, SPT1	<b>M30</b> Ground Spring <b>M53</b> Space Grade Micro-D, SPT2
<b>8 Special Instructions</b>	<b>YYY</b> Describe anything that is not covered in standard options	

# METAL SHELL MICRO-D NARROW RIGHT ANGLE .100 (TYPE SR1)

Omnetics **Micro-D Narrow Right Angle Thru-Hole board mount connectors** offer the traditional .100 inch pitch. These high-reliability connectors provide excellent shock and vibration performance and meet or exceed the requirements of MIL-DTL-83513 utilizing the rugged Omnetics flex pin contact.

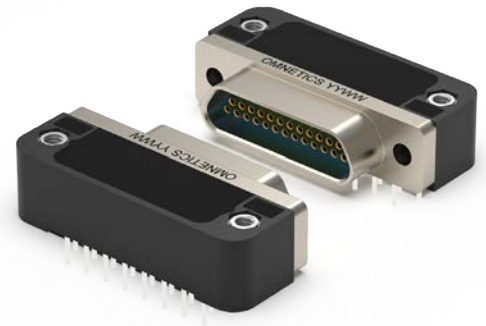

## Electro-Mechanical Specifications

TYPE	PERFORMANCE
Durability	> 2000 Mating Cycles min
Temperature	-55°C to +125°C (200 °C w/HTE)
Current rating	3 Amps per contact per MIL-DTL-83513
Voltage Rating (DWV)	600 VAC RMS Sea Level
Insulation Resistance	5,000 Megohms @ 500 VDC
Shock	50 g's with no discontinuities > 1 microsecond
Vibration	20 g's with no discontinuities > 1 microsecond
Thermal Vacuum Outgassing	1.0% max TML, 0.1% max CVCM - NASA SP-R-0022
Contact Resistance	26 milliohms (65 mV) max @ 2.5 Amps per MIL-DTL-83513
Mating/Unmating Force	3 oz. (.85g) typical per contact

## Material Specifications

TYPE	PERFORMANCE
Contact	Copper Alloy Per MIL-DTL-83513
Contact Finish	Gold per ASTM B488, Type II, Class 1.27, Code C Over Nickel Underplate
Insulator	Thermoplastic per MIL-DTL-83513
Interfacial Seal	Silicone Elastomer per A-A-59588
Hardware	Stainless Steel, 300 Series, Passivated per SAE AMS-2700

## Shell Options

MATERIAL	FINISH
Aluminum 6061	Electroless Nickel per SAE-AMS-2404
Stainless Steel, 300 Series	Passivated per SAE-AMS-2700

# METAL SHELL MICRO-D NARROW RIGHT ANGLE .100 (TYPE SR1)



See page 162 for recommended board layout

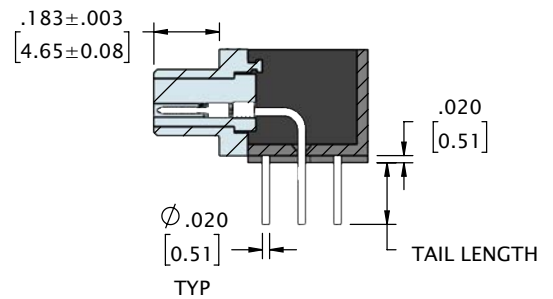
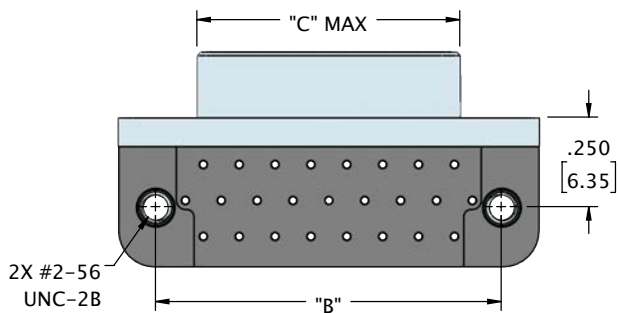
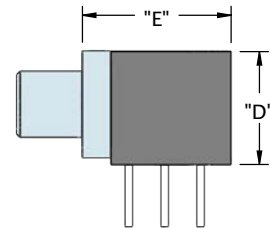
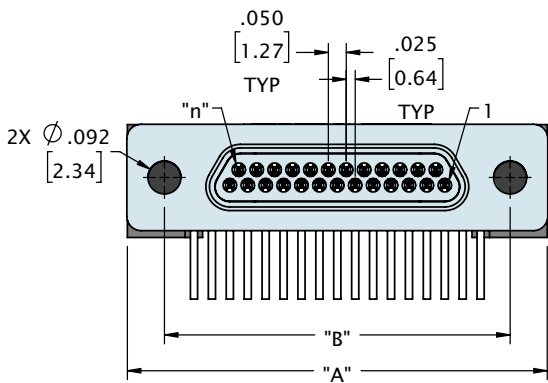

CONTACTS	ROWS	"A"	"B"	"C"	"D"	"E"
9	2	.775 [19.69]	.565 [14.35]	.334 [8.48]	.315 [8.00]	.415 [10.54]
15	2	.925 [23.50]	.715 [18.16]	.484 [12.29]	.315 [8.00]	.415 [10.54]
21	2	1.075 [27.31]	.865 [21.97]	.634 [16.10]	.315 [8.00]	.415 [10.54]
25	2	1.175 [29.85]	.965 [24.51]	.734 [18.64]	.315 [8.00]	.415 [10.54]
31	2	1.325 [33.66]	1.115 [28.32]	.884 [22.45]	.315 [8.00]	.515 [13.08]
37	2	1.475 [37.47]	1.265 [32.13]	1.034 [26.26]	.315 [8.00]	.515 [13.08]
51	3	1.425 [36.20]	1.215 [30.86]	.984 [24.99]	.350 [8.89]	.650 [16.51]

DIMENSIONS IN [ ] ARE IN MILLIMETERS AND ARE FOR REFERENCE ONLY

# METAL SHELL MICRO-D NARROW RIGHT ANGLE .100 (TYPE SR1)



See page 162 for recommended board layout

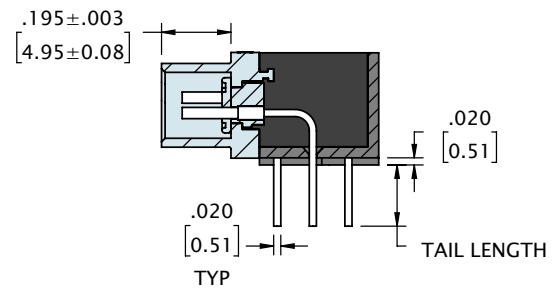
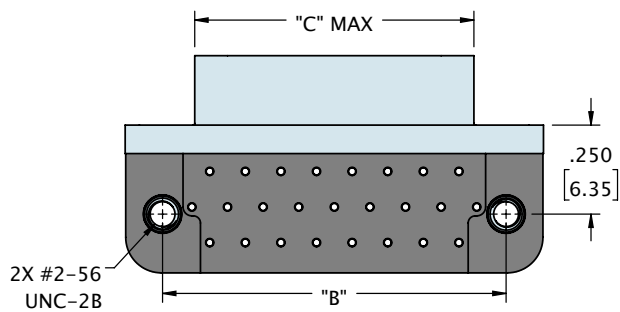
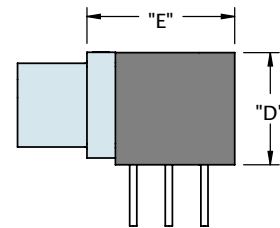
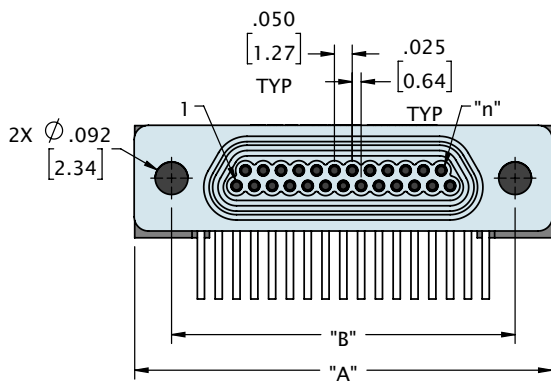

CONTACTS	ROWS	"A"	"B"	"C"	"D"	"E"
9	2	.775 [19.69]	.565 [14.35]	.400 [10.16]	.315 [8.00]	.415 [10.54]
15	2	.925 [23.50]	.715 [18.16]	.550 [13.97]	.315 [8.00]	.415 [10.54]
21	2	1.075 [27.31]	.865 [21.97]	.700 [17.78]	.315 [8.00]	.415 [10.54]
25	2	1.175 [29.85]	.965 [24.51]	.800 [20.32]	.315 [8.00]	.415 [10.54]
31	2	1.325 [33.66]	1.115 [28.32]	.950 [24.13]	.315 [8.00]	.515 [13.08]
37	2	1.475 [37.47]	1.265 [32.13]	1.100 [27.94]	.315 [8.00]	.515 [13.08]
51	3	1.425 [36.20]	1.215 [30.86]	1.100 [27.94]	.350 [8.89]	.650 [16.51]

DIMENSIONS IN [ ] ARE IN MILLIMETERS AND ARE FOR REFERENCE ONLY



## ORDERING GUIDE

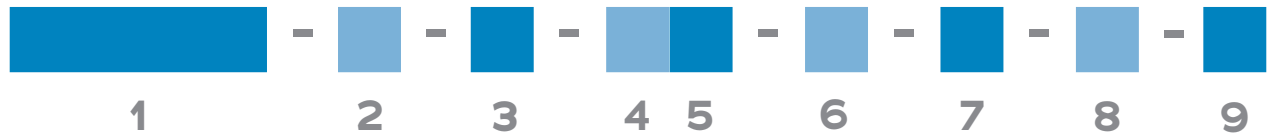

<b>1 Series</b>	<b>MMDP</b> Metal Micro-D Pin	<b>MMDS</b> Metal Micro-D Socket
<b>2 Number of Contacts</b>	<b>O09</b> <b>O15</b> <b>O21</b> <b>O25</b> <b>O31</b> <b>O37</b> <b>O51</b> *	
	* Use <b>513</b> for Three Rows O51	
<b>3 Termination Type</b>	<b>SR1</b> Narrow Right Angle .100	
<b>4 Shell Material &amp; Finish</b>	<b>N</b> Aluminum Shell, Electroless Nickel Plated <b>B</b> Aluminium Shell, Black Anodized	<b>CD</b> Aluminium Shell, Cadmium Plated <b>P</b> Stainless Steel Shell, Passivated
<b>5 Hardware</b>	<b>O0</b> None, Ø .092 Hole	<b>O1</b> Fixed Jack-posts (STD)
<b>6 Common Options</b>	<b>ETH</b> End Threaded Holes (#2-56 UNC-2B) <b>HT</b> High Temp Epoxy	<b>M</b> Plain Mounting Holes <b>RH</b> RoHS Compliant
<b>7 Mod Codes</b>	<b>M10</b> Keyed <b>M50</b> Space Grade Micro-D, SPT1	<b>M30</b> Ground Spring <b>M53</b> Space Grade Micro-D, SPT2
<b>8 Tail Length</b>	<b>.109</b> <b>.140</b> <b>.172</b>	
<b>9 Special Instructions</b>	<b>YYY</b> Describe anything that is not covered in standard options	

# METAL SHELL MICRO-D STANDARD VERTICAL BOARD MOUNT .075 (TYPE SV7)

Omnetics **Micro-D Standard Vertical Board Mount connectors** offer the traditional .075 inch terminal spacing design. These high-reliability connectors meet or exceed the shock and vibration requirements of MIL-DTL-83513 and utilize the rugged Omnetics flex pin contact.



## Electro-Mechanical Specifications

TYPE	PERFORMANCE
Durability	> 2000 Mating Cycles min
Temperature	-55°C to +125°C (200 °C w/HTE)
Current rating	3 Amps per contact per MIL-DTL-83513
Voltage Rating (DWV)	600 VAC RMS Sea Level
Insulation Resistance	5,000 Megohms @ 500 VDC
Shock	50 g's with no discontinuities > 1 microsecond
Vibration	20 g's with no discontinuities > 1 microsecond
Thermal Vacuum Outgassing	1.0% max TML, 0.1% max CVCM - NASA SP-R-0022
Contact Resistance	26 milliohms (65 mV) max @ 2.5 Amps per MIL-DTL-83513
Mating/Unmating Force	3 oz. (.85g) typical per contact

## Material Specifications

TYPE	PERFORMANCE
Contact	Copper Alloy Per MIL-DTL-83513
Contact Finish	Gold per ASTM B488, Type II, Class 1.27, Code C Over Nickel Underplate
Insulator	Thermoplastic per MIL-DTL-83513
Interfacial Seal	Silicone Elastomer per A-A-59588
Hardware	Stainless Steel, 300 Series, Passivated per SAE AMS-2700

## Shell Options

MATERIAL	FINISH
Aluminum 6061	Electroless Nickel per SAE-AMS-2404
Stainless Steel, 300 Series	Passivated per SAE-AMS-2700

# METAL SHELL MICRO-D STANDARD VERTICAL BOARD MOUNT .075 (TYPE SV7)

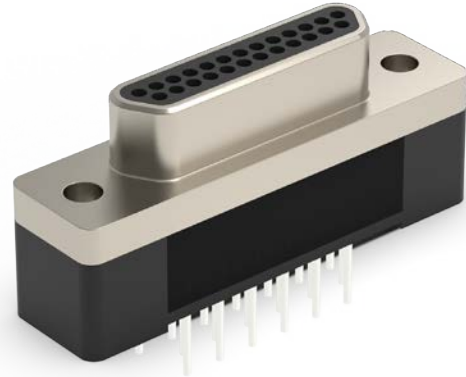

See page 163 for recommended board layout

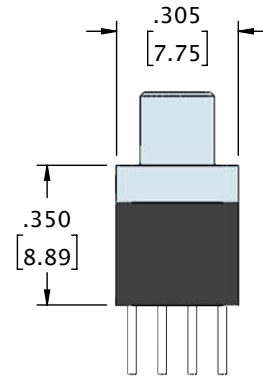
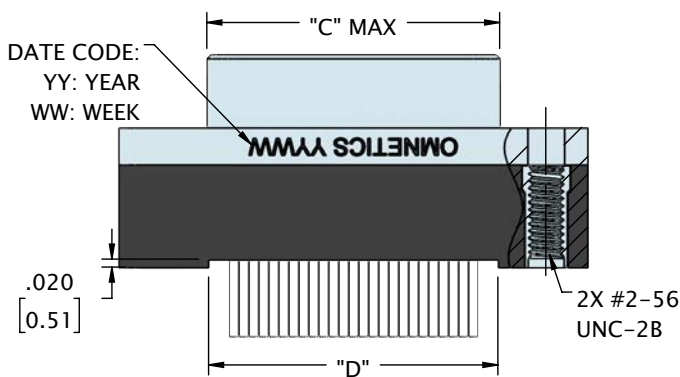
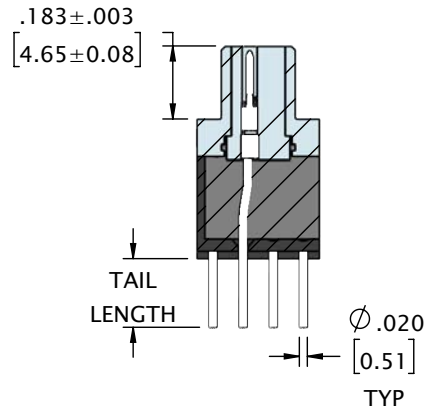
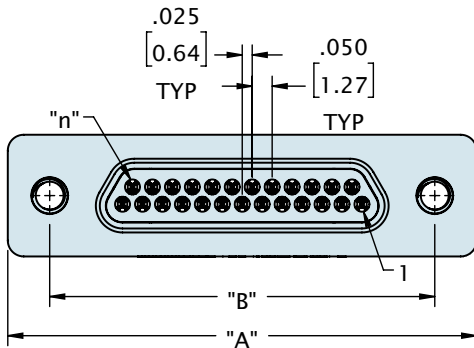

CONTACTS	ROWS	"A"	"B"	"C"	"D"
9	2	.775 [19.69]	.565 [14.35]	.334 [8.48]	.325 [8.26]
15	2	.925 [23.50]	.715 [18.16]	.484 [12.29]	.475 [12.07]
21	2	1.075 [27.31]	.865 [21.97]	.634 [16.10]	.625 [15.88]
25	2	1.175 [29.85]	.965 [24.51]	.734 [18.64]	.725 [18.42]
31	2	1.325 [33.66]	1.115 [28.32]	.884 [22.45]	.875 [22.23]
37	2	1.475 [37.47]	1.265 [32.13]	1.034 [26.26]	1.025 [26.04]

DIMENSIONS IN [ ] ARE IN MILLIMETERS AND ARE FOR REFERENCE ONLY

# METAL SHELL MICRO-D STANDARD VERTICAL BOARD MOUNT .075 (TYPE SV7)

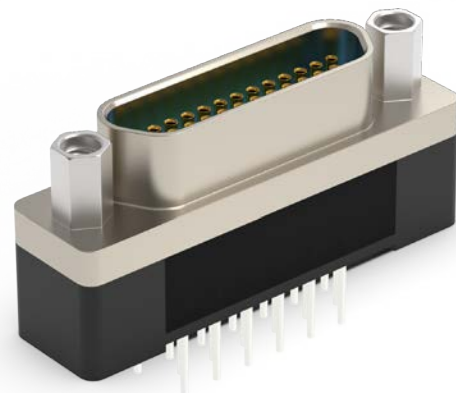
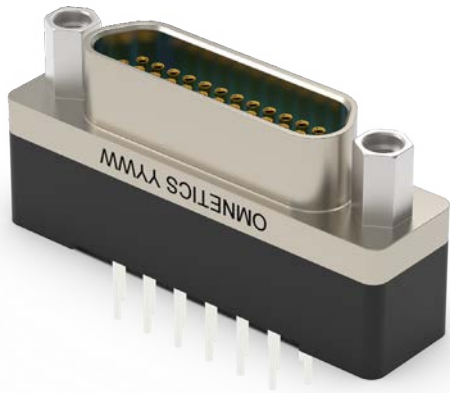

See page 163 for recommended board layout

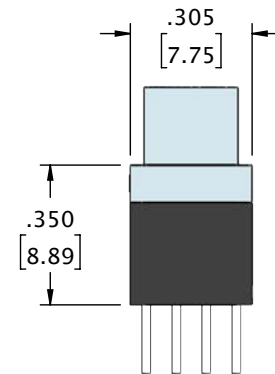
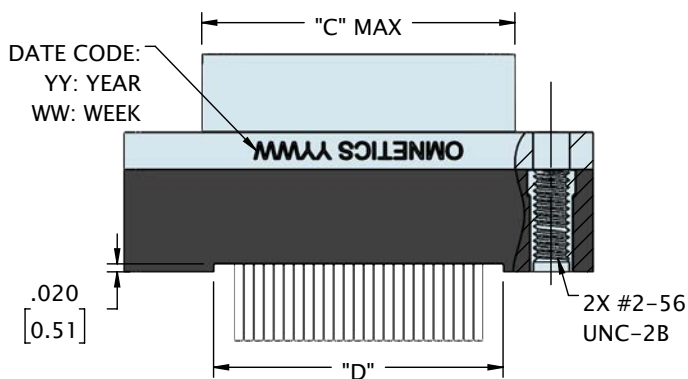
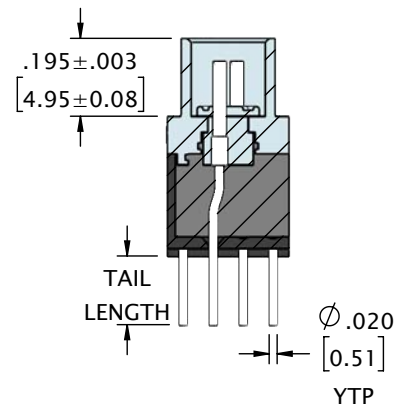
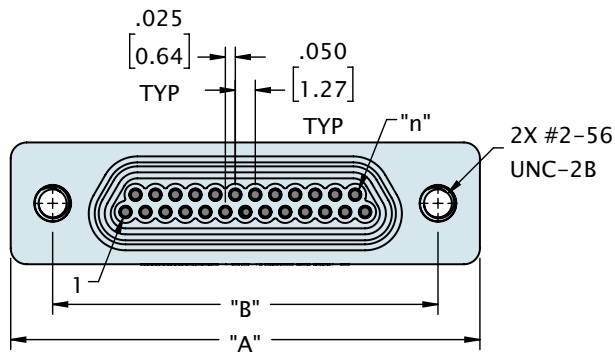

CONTACTS	ROWS	"A"	"B"	"C"	"D"
9	2	.775 [19.69]	.565 [14.35]	.400 [10.16]	.325 [8.26]
15	2	.925 [23.50]	.715 [18.16]	.550 [13.97]	.475 [12.07]
21	2	1.075 [27.31]	.865 [21.97]	.700 [17.78]	.625 [15.88]
25	2	1.175 [29.85]	.965 [24.51]	.800 [20.32]	.725 [18.42]
31	2	1.325 [33.66]	1.115 [28.32]	.950 [24.13]	.875 [22.23]
37	2	1.475 [37.47]	1.265 [32.13]	1.100 [27.94]	1.025 [26.04]

DIMENSIONS IN [ ] ARE IN MILLIMETERS AND ARE FOR REFERENCE ONLY

### ORDERING GUIDE

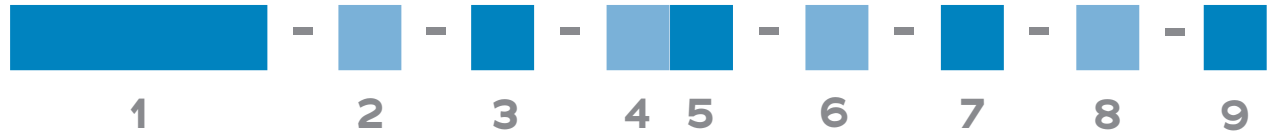

<b>1 Series</b>	<b>MMDP</b> Metal Micro-D Pin	<b>MMDS</b> Metal Micro-D Socket
<b>2 Number of Contacts</b>	<b>009</b> <b>015</b> <b>021</b> <b>025</b> <b>031</b> <b>037</b>	
<b>3 Termination Type</b>	<b>SV7</b> Standard Vertical Board Mount .075	
<b>4 Shell Material &amp; Finish</b>	<b>N</b> Aluminium Shell, Electroless Nickel Plated <b>B</b> Aluminium Shell, Black Anodized	<b>CD</b> Aluminium Shell, Cadmium Plated <b>P</b> Stainless Steel Shell, Passivated
<b>5 Hardware</b>	<b>00</b> None, Ø .092 Hole	<b>01</b> Fixed Jack-posts (STD)
<b>6 Common Options</b>	<b>ETH</b> End Threaded Holes (#2-56 UNC-2B) <b>HT</b> High Temp Epoxy	<b>M</b> Plain Mounting Holes <b>RH</b> RoHS Compliant
<b>7 Mod Codes</b>	<b>M10</b> Keyed <b>M50</b> Space Grade Micro-D, SPT1	<b>M30</b> Ground Spring <b>M53</b> Space Grade Micro-D, SPT2
<b>8 Tail Length</b>	<b>.109</b> <b>.140</b> <b>.172</b>	
<b>9 Special Instructions</b>	<b>YYY</b> Describe anything that is not covered in standard options	

# LOW PROFILE MICRO-D DISCRETE LEADWIRE (TYPE WD)

Omnetics' **Low-Profile Micro-D Discrete Leadwire connectors** measure 2.34 mm thinner than a standard Micro-D, and feature flexible leadwire cabling to give designers the flexibility to create streamlined systems. These powerful connectors are ideal for small devices for the military, aerospace, oil and gas, and medical industries, such as optics, guidance systems, and on-board equipment. They can endure more than 2,000 mating cycles in operating conditions that include temperate extremes ranging from -55° to 200°C. Available in a range of shell, plating, and pin options to meet your system requirements.



## Electro-Mechanical Specifications

TYPE	PERFORMANCE
Durability	> 2000 Mating Cycles min
Temperature	-55°C to +125°C (200 °C w/HTE)
Current rating	3 Amps per contact per MIL-DTL-83513
Voltage Rating (DWV)	600 VAC RMS Sea Level
Insulation Resistance	5,000 Megohms @ 500 VDC
Shock	50 g's with no discontinuities > 1 microsecond
Vibration	20 g's with no discontinuities > 1 microsecond
Thermal Vacuum Outgassing	1.0% max TML, 0.1% max CVCM - NASA SP-R-0022
Contact Resistance	26 milliohms (65 mV) max @ 2.5 Amps per MIL-DTL-83513
Mating/Unmating Force	3 oz. (.85g) typical per contact

## Material Specifications

TYPE	PERFORMANCE
Contact	Copper Alloy Per MIL-DTL-83513
Contact Finish	Gold per ASTM B488, Type II, Class 1.27, Code C Over Nickel Underplate
Insulator	Thermoplastic per MIL-DTL-83513
Interfacial Seal	Silicone Elastomer per A-A-59588
Hardware	Stainless Steel, 300 Series, Passivated per SAE AMS-2700

## Shell Options

MATERIAL	FINISH
Aluminum 6061	Electroless Nickel per SAE-AMS-2404
Stainless Steel, 300 Series	Passivated per SAE-AMS-2700

# LOW PROFILE MICRO-D DISCRETE LEADWIRE (TYPE WD)

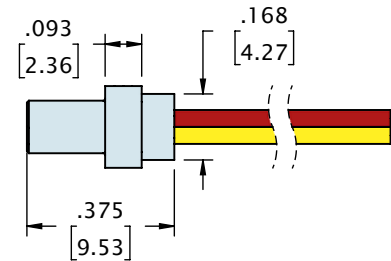
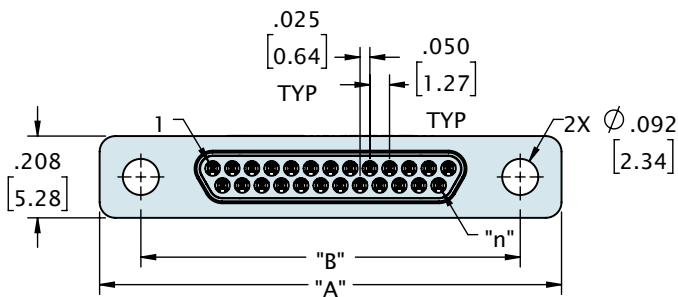
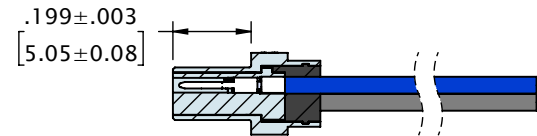
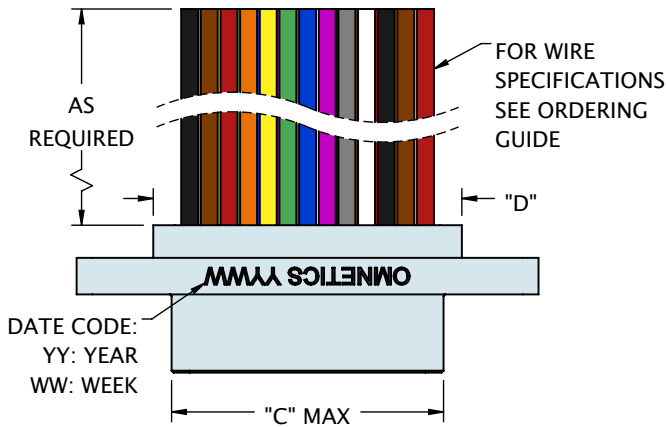

CONTACTS	ROWS	"A"	"B"	"C"	"D"
9	2	.775 [19.69]	.565 [14.35]	.292 [7.42]	.385 [9.78]
15	2	.925 [23.50]	.715 [18.16]	.442 [11.23]	.535 [13.59]
21	2	1.075 [27.31]	.865 [21.97]	.592 [15.04]	.685 [17.40]
25	2	1.175 [29.85]	.965 [24.51]	.692 [17.58]	.785 [19.94]
31	2	1.325 [33.66]	1.115 [28.32]	.842 [21.39]	.935 [23.75]
37	2	1.475 [37.47]	1.265 [32.13]	.992 [25.20]	1.085 [27.56]

DIMENSIONS IN [ ] ARE IN MILLIMETERS AND ARE FOR REFERENCE ONLY

# LOW PROFILE MICRO-D DISCRETE LEADWIRE (TYPE WD)

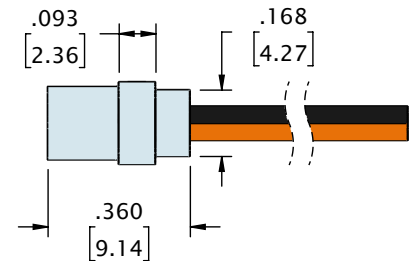
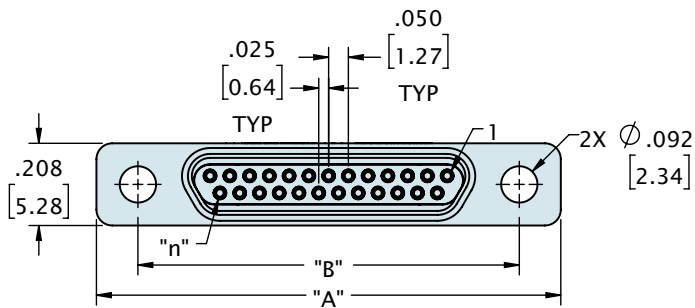
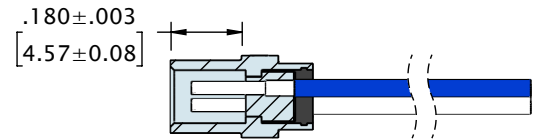
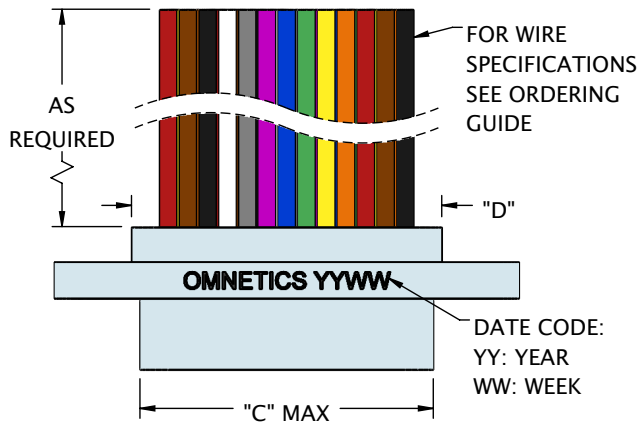
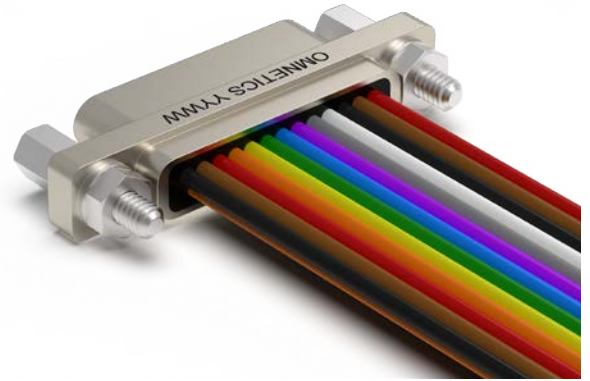
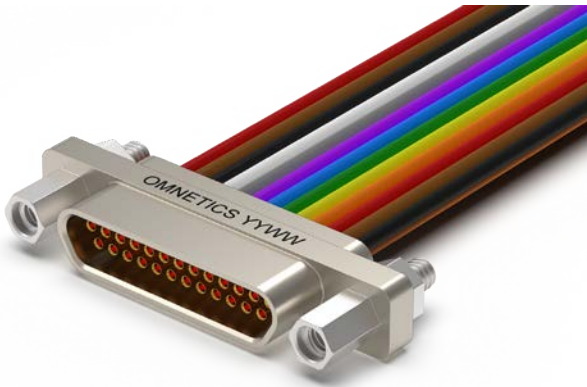

CONTACTS	ROWS	"A"	"B"	"C"	"D"
9	2	.775 [19.69]	.565 [14.35]	.358 [9.09]	.385 [9.78]
15	2	.925 [23.50]	.715 [18.16]	.508 [12.90]	.535 [13.59]
21	2	1.075 [27.31]	.865 [21.97]	.658 [16.71]	.685 [17.40]
25	2	1.175 [29.85]	.965 [24.51]	.758 [19.25]	.785 [19.94]
31	2	1.325 [33.66]	1.115 [28.32]	.908 [23.06]	.935 [23.75]
37	2	1.475 [37.47]	1.265 [32.13]	1.058 [26.87]	1.085 [27.56]

DIMENSIONS IN [ ] ARE IN MILLIMETERS AND ARE FOR REFERENCE ONLY



## ORDERING GUIDE



<b>1 Series</b>	<b>MDLP</b> Low Profile Micro-D Pin	<b>MDLS</b> Low Profile Micro-D Socket
<b>2 Number of Contacts</b>	<b>009</b> <b>015</b> <b>021</b> <b>025</b> <b>031</b>	<b>037</b>
<b>3 Termination Type</b>	<b>WD</b> Discrete Leadwire	
<b>4 Wire AWG</b>	<b>4</b> 24 AWG	<b>6</b> 26 AWG (STD) <b>8</b> 28 AWG <b>0</b> 30 AWG
<b>5 Wire Type</b>	<b>Q</b> Nema HP3 (STD) <b>R</b> M22759/11	<b>S</b> M22759/33 <b>X</b> Other
<b>6 Wire Length (inches)</b>	<b>18.0</b> 18.00 (STD)	<b>XX.X</b> Custom length
<b>7 Color Scheme</b>	<b>1</b> 10 Repeating <b>2</b> Blue <b>3</b> White	<b>4</b> Non Repeating <b>5</b> Yellow
<b>8 Shell Material &amp; Finish</b>	<b>N</b> Aluminum Shell, Electroless Nickel Plated <b>B</b> Aluminium Shell, Black Anodized	<b>CD</b> Aluminium Shell, Cadmium Plated <b>P</b> Stainless Steel Shell, Passivated
<b>9 Hardware</b>	<b>00</b> None, Ø .092 Hole <b>02</b> Jackscrews, STD Length, Hex (MMDP - STD) <b>04</b> Jackscrews, Long Length, Hex <b>06</b> Float Mount, Front Mounted <b>08</b> Non-Removable	<b>01</b> Fixed Jack-posts (MMDS - STD) <b>03</b> Jackscrews, STD Length, Slotted <b>05</b> Jackscrews, Long Length, Slotted <b>07</b> Float Mount, Rear Mounted <b>YY</b> Non Standard Hardware
<b>10 Common Options</b>	<b>PA</b> Panel Mount Rear, O-Ring <b>IBS</b> Integrated Backshell <b>HT</b> High Temp Epoxy	<b>PB</b> Panel Mount, Rear <b>BSY</b> Custom Backshell <b>RH</b> RoHS Compliant
<b>11 Shield / Jacket</b>	<b>D</b> Slip On Metal Braid <b>E</b> Machine Braid <b>F</b> Flexo Braid <b>J</b> Nomex Braid <b>ST</b> Shrink Tube	
<b>12 Mod Codes</b>	<b>M10</b> Keyed <b>M30</b> Ground Spring <b>M50</b> Space Grade Micro-D, SPT1 <b>M53</b> Space Grade Micro-D, SPT2	
<b>13 Special Instructions</b>	<b>YYY</b> Describe anything that is not covered in standard options	

# LOW PROFILE MICRO-D SOLDER CUP (TYPE SS)

Omnetics' **Low Profile Micro-D Solder Cup connectors** serve rugged designs that require highly stable and secure connections. Our gold-plated one-piece Flex Pin system helps this tiny connector absorb the shock and vibration that small electronics routinely endure in the field. We engineered our solder cup shell configuration to provide exceptional reliability for critical applications in the aerospace, military, oil and gas, medical, and other industries. Omnetics builds these rugged connectors to meet or exceed the demanding requirements of MIL-DTL-83513. They can endure more than 2,000 mating cycles in operating conditions that include temperate extremes ranging from -55° to 200°C.



## Electro-Mechanical Specifications

TYPE	PERFORMANCE
Durability	> 2000 Mating Cycles min
Temperature	-55°C to +125°C (200 °C w/HTE)
Current rating	3 Amps per contact per MIL-DTL-83513
Voltage Rating (DWV)	600 VAC RMS Sea Level
Insulation Resistance	5,000 Megohms @ 500 VDC
Shock	50 g's with no discontinuities > 1 microsecond
Vibration	20 g's with no discontinuities > 1 microsecond
Thermal Vacuum Outgassing	1.0% max TML, 0.1% max CVCM - NASA SP-R-0022
Contact Resistance	26 milliohms (65 mV) max @ 2.5 Amps per MIL-DTL-83513
Mating/Unmating Force	3 oz. (.85g) typical per contact

## Material Specifications

TYPE	PERFORMANCE
Contact	Copper Alloy Per MIL-DTL-83513
Contact Finish	Gold per ASTM B488, Type II, Class 1.27, Code C Over Nickel Underplate
Insulator	Thermoplastic per MIL-DTL-83513
Interfacial Seal	Silicone Elastomer per A-A-59588
Hardware	Stainless Steel, 300 Series, Passivated per SAE AMS-2700

## Shell Options

MATERIAL	FINISH
Aluminum 6061	Electroless Nickel per SAE-AMS-2404
Stainless Steel, 300 Series	Passivated per SAE-AMS-2700

# LOW PROFILE MICRO-D SOLDER CUP (TYPE SS)

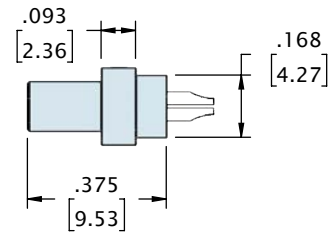
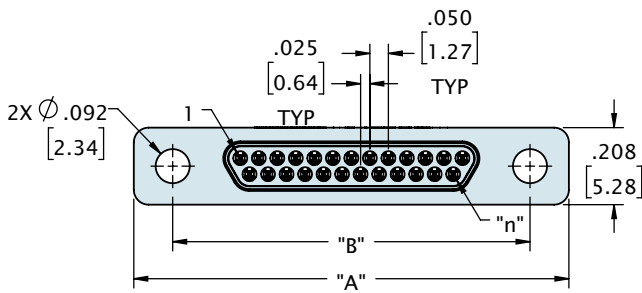
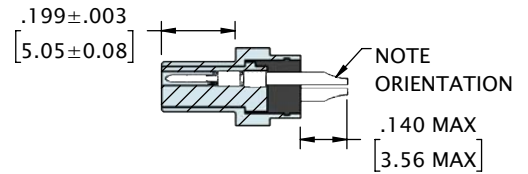
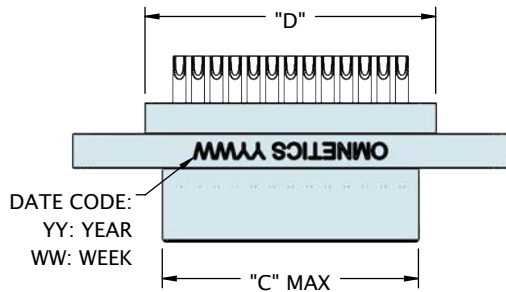

CONTACTS	ROWS	"A"	"B"	"C"	"D"
9	2	.775 [19.69]	.565 [14.35]	.292 [7.42]	.385 [9.78]
15	2	.925 [23.50]	.715 [18.16]	.442 [11.23]	.535 [13.59]
21	2	1.075 [27.31]	.865 [21.97]	.592 [15.04]	.685 [17.40]
25	2	1.175 [29.85]	.965 [24.51]	.692 [17.58]	.785 [19.94]
31	2	1.325 [33.66]	1.115 [28.32]	.842 [21.39]	.935 [23.75]
37	2	1.475 [37.47]	1.265 [32.13]	.992 [25.20]	1.085 [27.56]

DIMENSIONS IN [ ] ARE IN MILLIMETERS AND ARE FOR REFERENCE ONLY

# LOW PROFILE MICRO-D SOLDER CUP (TYPE SS)

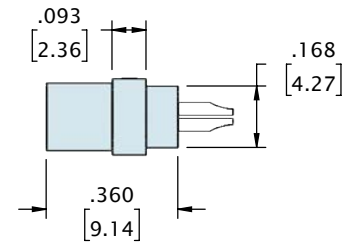
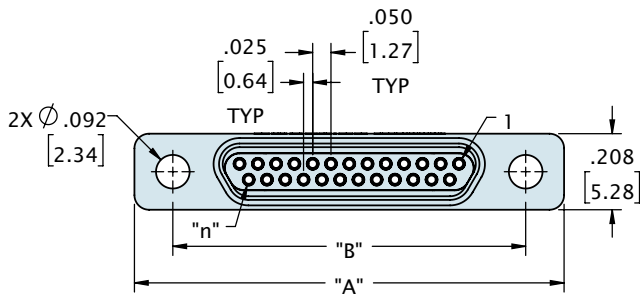
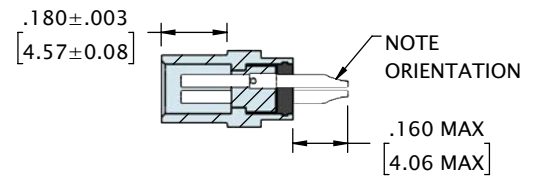
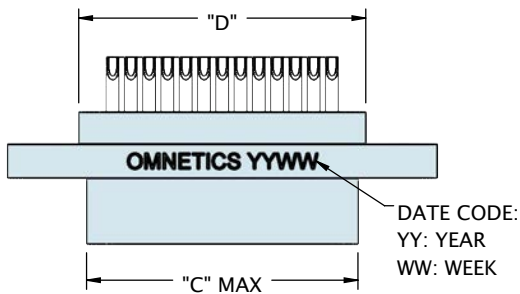

CONTACTS	ROWS	"A"	"B"	"C"	"D"
9	2	.775 [19.69]	.565 [14.35]	.358 [9.09]	.385 [9.78]
15	2	.925 [23.50]	.715 [18.16]	.508 [12.90]	.535 [13.59]
21	2	1.075 [27.31]	.865 [21.97]	.658 [16.71]	.685 [17.40]
25	2	1.175 [29.85]	.965 [24.51]	.758 [19.25]	.785 [19.94]
31	2	1.325 [33.66]	1.115 [28.32]	.908 [23.06]	.935 [23.75]
37	2	1.475 [37.47]	1.265 [32.13]	1.058 [26.87]	1.085 [27.56]

DIMENSIONS IN [ ] ARE IN MILLIMETERS AND ARE FOR REFERENCE ONLY

## ORDERING GUIDE

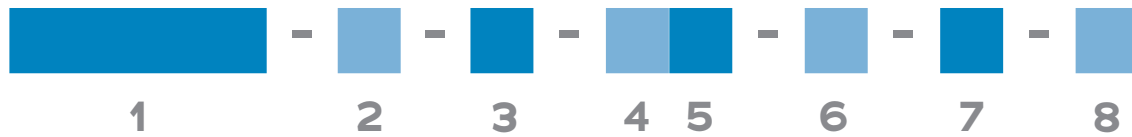

<b>1 Series</b>	<b>MDLP</b> Low Profile Micro-D Pin	<b>MDLS</b> Low Profile Micro-D Socket
<b>2 Number of Contacts</b>	<b>009</b> <b>015</b> <b>021</b> <b>025</b> <b>031</b> <b>037</b>	
<b>3 Termination Type</b>	<b>SS</b> Soldercup	
<b>4 Shell Material &amp; Finish</b>	<b>N</b> Aluminum Shell, Electroless Nickel Plated <b>B</b> Aluminium Shell, Black Anodized	<b>CD</b> Aluminium Shell, Cadmium Plated <b>P</b> Stainless Steel Shell, Passivated
<b>5 Hardware</b>	<b>00</b> None, Ø .092 Hole <b>02</b> Jackscrews, STD Length, Hex (MMDP - STD) <b>04</b> Jackscrews, Long Length, Hex <b>06</b> Float Mount, Front Mounted <b>08</b> Non-Removable	<b>01</b> Fixed Jack-posts (MMDS - STD) <b>03</b> Jackscrews, STD Length, Slotted <b>05</b> Jackscrews, Long Length, Slotted <b>07</b> Float Mount, Rear Mounted <b>YY</b> Non Standard Hardware
<b>6 Common Options</b>	<b>BSY</b> Custom Backshell <b>RH</b> RoHS Compliant	<b>HT</b> High Temp Epoxy
<b>7 Mod Codes</b>	<b>M10</b> Keyed <b>M50</b> Space Grade Micro-D, SPT1	<b>M30</b> Ground Spring <b>M53</b> Space Grade Micro-D, SPT2
<b>8 Special Instructions</b>	<b>YYY</b> Describe anything that is not covered in standard options	

# LOW PROFILE MICRO-D HORIZONTAL SURFACE MOUNT (TYPE HO)

Omnetrics **Low Profile Micro-D Horizontal Surface Mount connectors** offer a compact design for high-reliability application. These connector are highly rugged and feature a .050 inch row spacing board footprint. Built to meet or exceed the specifications of MIL-DTL-83513 and feature Omnetrics flex pin design.



## Electro-Mechanical Specifications

TYPE	PERFORMANCE
Durability	> 2000 Mating Cycles min
Temperature	-55°C to +125°C (200 °C w/HTE)
Current rating	3 Amps per contact per MIL-DTL-83513
Voltage Rating (DWV)	600 VAC RMS Sea Level
Insulation Resistance	5,000 Megohms @ 500 VDC
Shock	50 g's with no discontinuities > 1 microsecond
Vibration	20 g's with no discontinuities > 1 microsecond
Thermal Vacuum Outgassing	1.0% max TML, 0.1% max CVCM - NASA SP-R-0022
Contact Resistance	26 milliohms (65 mV) max @ 2.5 Amps per MIL-DTL-83513
Mating/Unmating Force	3 oz. (.85g) typical per contact

## Material Specifications

TYPE	PERFORMANCE
Contact	Copper Alloy Per MIL-DTL-83513
Contact Finish	Gold per ASTM B488, Type II, Class 1.27, Code C Over Nickel Underplate
Insulator	Thermoplastic per MIL-DTL-83513
Interfacial Seal	Silicone Elastomer per A-A-59588
Hardware	Stainless Steel, 300 Series, Passivated per SAE AMS-2700

## Shell Options

MATERIAL	FINISH
Aluminum 6061	Electroless Nickel per SAE-AMS-2404
Stainless Steel, 300 Series	Passivated per SAE-AMS-2700

# LOW PROFILE MICRO-D HORIZONTAL SURFACE MOUNT (TYPE HO)

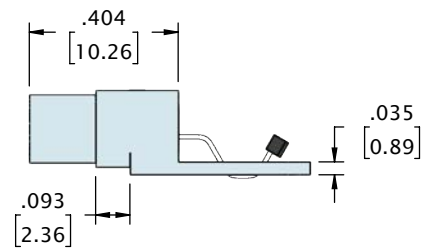
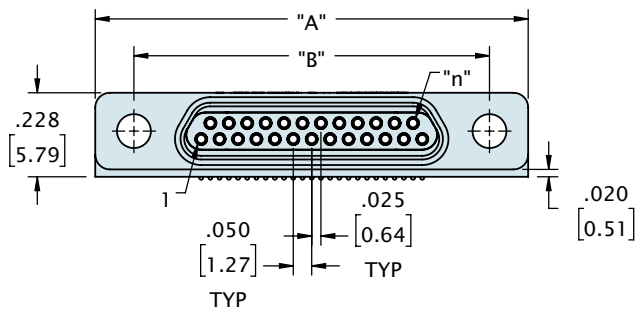
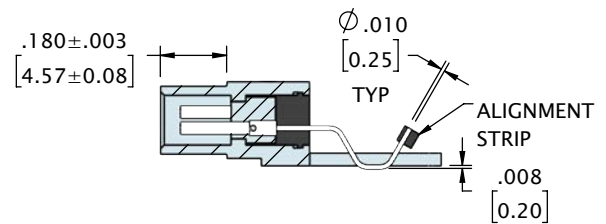
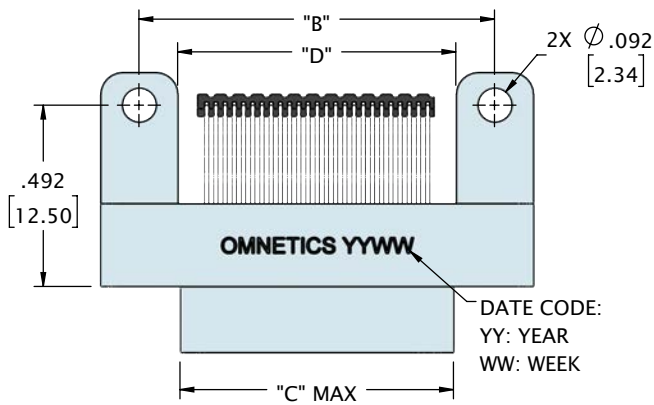

CONTACTS	ROWS	"A"	"B"	"C"	"D"
9	2	.775 [19.69]	.565 [14.35]	.292 [7.42]	.355 [9.02]
15	2	.925 [23.50]	.715 [18.16]	.442 [11.23]	.505 [12.83]
21	2	1.075 [27.31]	.865 [21.97]	.592 [15.04]	.655 [16.64]
25	2	1.175 [29.85]	.965 [24.51]	.692 [17.58]	.755 [19.18]
31	2	1.325 [33.66]	1.115 [28.32]	.842 [21.39]	.905 [22.99]
37	2	1.475 [37.47]	1.265 [32.13]	.992 [25.20]	1.055 [26.80]

DIMENSIONS IN [ ] ARE IN MILLIMETERS AND ARE FOR REFERENCE ONLY

*This page intentionally left blank.*



## ORDERING GUIDE

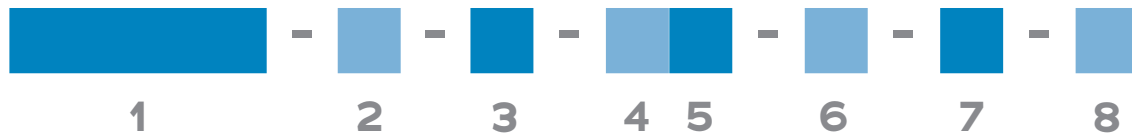

<b>1 Series</b>	MDLS Low Profile Micro-D Socket	
<b>2 Number of Contacts</b>	O09	O15 O21 O25 O31 O37
<b>3 Termination Type</b>	HO Horizontal Surface Mount	
<b>4 Shell Material &amp; Finish</b>	N Aluminium Shell, Electroless Nickel Plated B Aluminium Shell, Black Anodized	CD Aluminium Shell, Cadmium Plated P Stainless Steel Shell, Passivated
<b>5 Hardware</b>	O0 None, Ø .092 Hole O2 Jackscrews, STD Length, Hex O4 Jackscrews, Long Length, Hex	O1 Fixed Jack-posts (STD) O3 Jackscrews, STD Length, Slotted O5 Jackscrews, Long Length, Slotted
<b>6 Common Options</b>	HT High Temp Epoxy	RH RoHS Compliant
<b>7 Mod Codes</b>	M10 Keyed M50 Space Grade Micro-D, SPT1	M30 Ground Spring M53 Space Grade Micro-D, SPT2
<b>8 Special Instructions</b>	YYY Describe anything that is not covered in standard options	

# LOW PROFILE MICRO-D VERTICAL SURFACE MOUNT (TYPE VV)

Omnetics **Low Profile Micro-D Vertical Surface Mount connectors** feature a .050 inch row spacing compact board footprint design. These high-reliability connectors meet or exceed the shock and vibration requirements of MIL-DTL-83513 and utilize the rugged Omnetics flex pin contact.



## Electro-Mechanical Specifications

TYPE	PERFORMANCE
Durability	> 2000 Mating Cycles min
Temperature	-55°C to +125°C (200 °C w/HTE)
Current rating	3 Amps per contact per MIL-DTL-83513
Voltage Rating (DWV)	600 VAC RMS Sea Level
Insulation Resistance	5,000 Megohms @ 500 VDC
Shock	50 g's with no discontinuities > 1 microsecond
Vibration	20 g's with no discontinuities > 1 microsecond
Thermal Vacuum Outgassing	1.0% max TML, 0.1% max CVCM - NASA SP-R-0022
Contact Resistance	26 milliohms (65 mV) max @ 2.5 Amps per MIL-DTL-83513
Mating/Unmating Force	3 oz. (.85g) typical per contact

## Material Specifications

TYPE	PERFORMANCE
Contact	Copper Alloy Per MIL-DTL-83513
Contact Finish	Gold per ASTM B488, Type II, Class 1.27, Code C Over Nickel Underplate
Insulator	Thermoplastic per MIL-DTL-83513
Interfacial Seal	Silicone Elastomer per A-A-59588
Hardware	Stainless Steel, 300 Series, Passivated per SAE AMS-2700

## Shell Options

MATERIAL	FINISH
Aluminum 6061	Electroless Nickel per SAE-AMS-2404
Stainless Steel, 300 Series	Passivated per SAE-AMS-2700

# LOW PROFILE MICRO-D VERTICAL SURFACE MOUNT (TYPE VV)

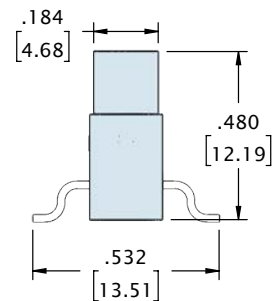
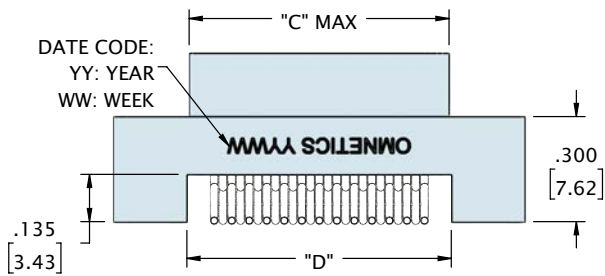
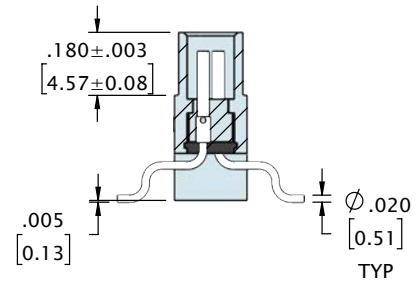
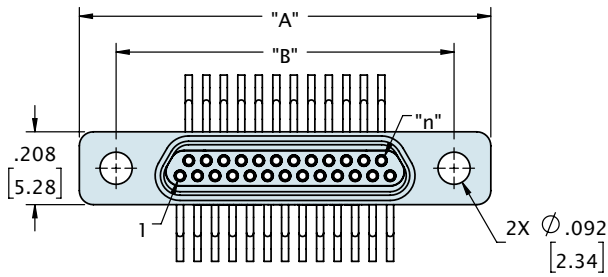
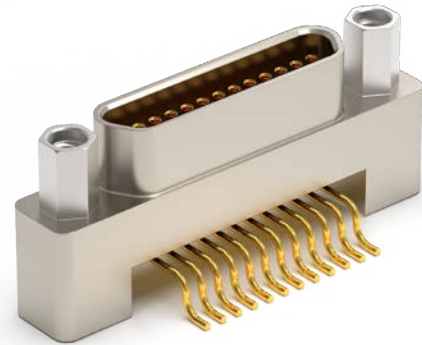

CONTACTS	ROWS	"A"	"B"	"C"	"D"
9	2	.775 [19.69]	.565 [14.35]	.358 [9.09]	.355 [9.02]
15	2	.925 [23.50]	.715 [18.16]	.508 [12.90]	.505 [12.83]
21	2	1.075 [27.31]	.865 [21.97]	.658 [16.71]	.655 [16.64]
25	2	1.175 [29.85]	.965 [24.51]	.758 [19.25]	.755 [19.18]
31	2	1.325 [33.66]	1.115 [28.32]	.908 [23.06]	.905 [22.99]
37	2	1.475 [37.47]	1.265 [32.13]	1.058 [26.87]	1.055 [26.80]

DIMENSIONS IN [ ] ARE IN MILLIMETERS AND ARE FOR REFERENCE ONLY

*This page intentionally left blank.*

## ORDERING GUIDE

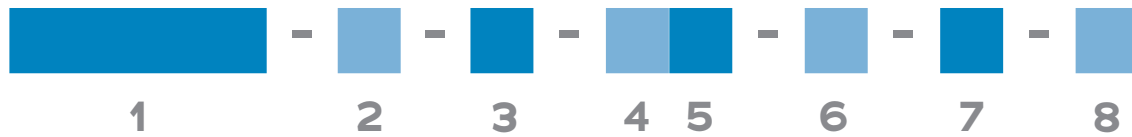

<b>1 Series</b>	MDLS Low Profile Micro-D Socket	
<b>2 Number of Contacts</b>	O09	O15 O21 O25 O31 O37
<b>3 Termination Type</b>	VV Vertical Surface Mount	
<b>4 Shell Material &amp; Finish</b>	N Aluminium Shell, Electroless Nickel Plated B Aluminium Shell, Black Anodized	CD Aluminium Shell, Cadmium Plated P Stainless Steel Shell, Passivated
<b>5 Hardware</b>	OO None, Ø .092 Hole	O1 Fixed Jack-posts (STD)
<b>6 Common Options</b>	HT High Temp Epoxy	RH RoHS Compliant
<b>7 Mod Codes</b>	M10 Keyed M50 Space Grade Micro-D, SPT1	M30 Ground Spring M53 Space Grade Micro-D, SPT2
<b>8 Special Instructions</b>	YYY Describe anything that is not covered in standard options	

# LOW PROFILE MICRO-D STRAIGHT THRU-HOLE (TYPE DD)

Make a precise, secure connection with Omnetics' streamlined **Low Profile Micro-D Straight Thru-Hole connectors**. These connectors serve the size, weight, and power (SWaP) priorities of today's compact device designs, while offering the additional reliability of a thru-hole connection. They are 2.34 mm thinner than a standard Micro-D. They are ideal for small military, aerospace, oil and gas, and medical applications, such as optics, guidance systems, and on-board equipment. Omnetics builds these connectors to meet or exceed the demanding requirements of MIL-DTL-83513. They can endure more than 2,000 mating cycles in operating conditions that include temperate extremes ranging from -55° to 200°C.



## Electro-Mechanical Specifications

TYPE	PERFORMANCE
Durability	> 2000 Mating Cycles min
Temperature	-55°C to +125°C (200 °C w/HTE)
Current rating	3 Amps per contact per MIL-DTL-83513
Voltage Rating (DWV)	600 VAC RMS Sea Level
Insulation Resistance	5,000 Megohms @ 500 VDC
Shock	50 g's with no discontinuities > 1 microsecond
Vibration	20 g's with no discontinuities > 1 microsecond
Thermal Vacuum Outgassing	1.0% max TML, 0.1% max CVCM - NASA SP-R-0022
Contact Resistance	26 milliohms (65 mV) max @ 2.5 Amps per MIL-DTL-83513
Mating/Unmating Force	3 oz. (.85g) typical per contact

## Material Specifications

TYPE	PERFORMANCE
Contact	Copper Alloy Per MIL-DTL-83513
Contact Finish	Gold per ASTM B488, Type II, Class 1.27, Code C Over Nickel Underplate
Insulator	Thermoplastic per MIL-DTL-83513
Interfacial Seal	Silicone Elastomer per A-A-59588
Hardware	Stainless Steel, 300 Series, Passivated per SAE AMS-2700

## Shell Options

MATERIAL	FINISH
Aluminum 6061	Electroless Nickel per SAE-AMS-2404
Stainless Steel, 300 Series	Passivated per SAE-AMS-2700

# LOW PROFILE MICRO-D STRAIGHT THRU-HOLE (TYPE DD)

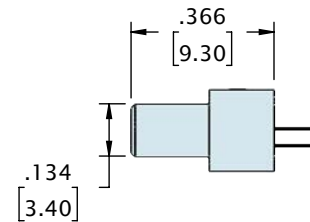
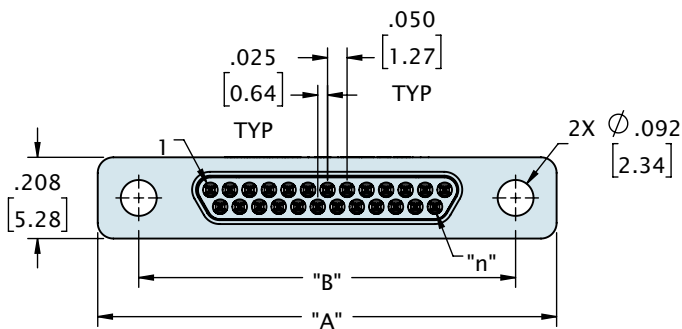
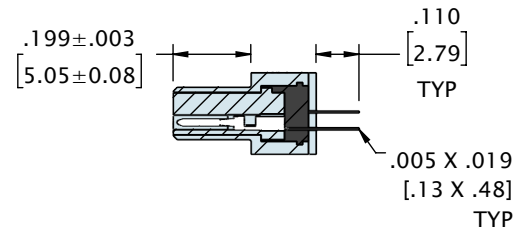
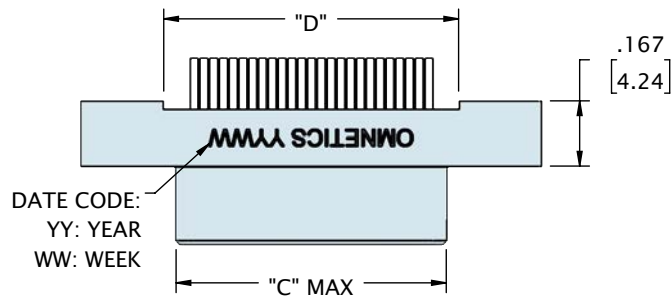

CONTACTS	ROWS	"A"	"B"	"C"	"D"
9	2	.775 [19.69]	.565 [14.35]	.292 [7.42]	.355 [9.02]
15	2	.925 [23.50]	.715 [18.16]	.442 [11.23]	.505 [12.83]
21	2	1.075 [27.31]	.865 [21.97]	.592 [15.04]	.655 [16.64]
25	2	1.175 [29.85]	.965 [24.51]	.692 [17.58]	.755 [19.18]
31	2	1.325 [33.66]	1.115 [28.32]	.842 [21.39]	.905 [22.99]
37	2	1.475 [37.47]	1.265 [32.13]	.992 [25.20]	1.055 [26.80]

DIMENSIONS IN [ ] ARE IN MILLIMETERS AND ARE FOR REFERENCE ONLY

# LOW PROFILE MICRO-D STRAIGHT THRU-HOLE (TYPE DD)

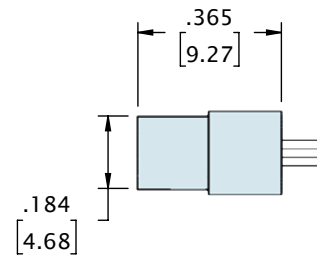
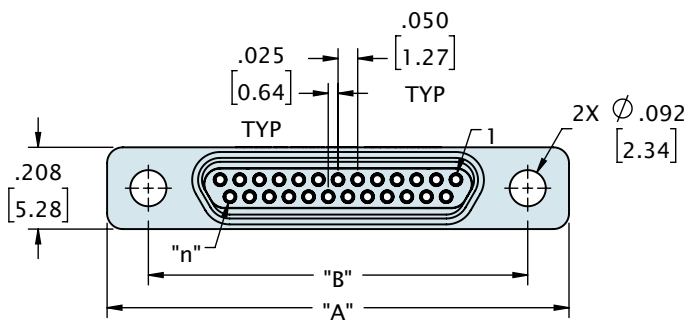
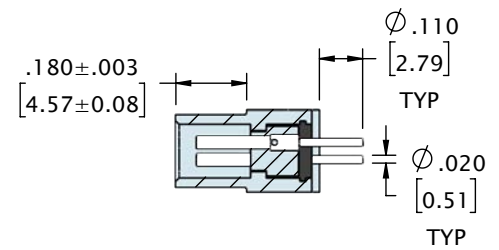
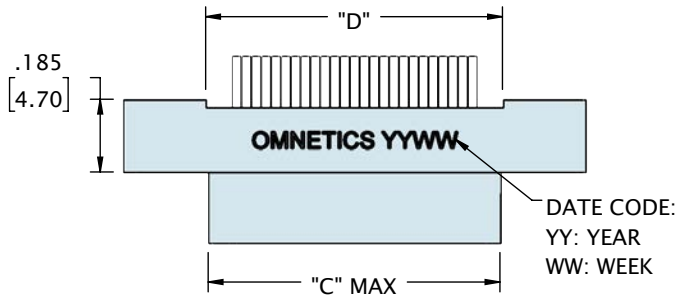

CONTACTS	ROWS	"A"	"B"	"C"	"D"
9	2	.775 [19.69]	.565 [14.35]	.358 [9.09]	.355 [9.02]
15	2	.925 [23.50]	.715 [18.16]	.508 [12.90]	.505 [12.83]
21	2	1.075 [27.31]	.865 [21.97]	.658 [16.71]	.655 [16.64]
25	2	1.175 [29.85]	.965 [24.51]	.758 [19.25]	.755 [19.18]
31	2	1.325 [33.66]	1.115 [28.32]	.908 [23.06]	.905 [22.99]
37	2	1.475 [37.47]	1.265 [32.13]	1.058 [26.87]	1.055 [26.80]

DIMENSIONS IN [ ] ARE IN MILLIMETERS AND ARE FOR REFERENCE ONLY



## ORDERING GUIDE

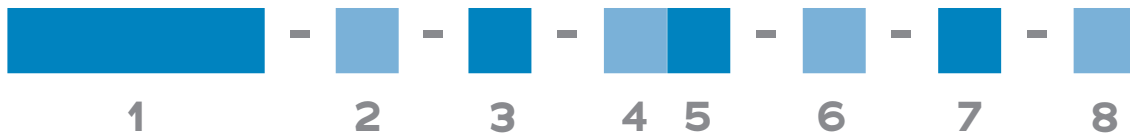

<b>1 Series</b>	<b>MDLP</b> Low Profile Micro-D Pin	<b>MDLS</b> Low Profile Micro-D Socket
<b>2 Number of Contacts</b>	<b>O09</b> <b>O15</b> <b>O21</b> <b>O25</b> <b>O31</b> <b>O37</b>	
<b>3 Termination Type</b>	<b>DD</b> Straight Thru-Hole	
<b>4 Shell Material &amp; Finish</b>	<b>N</b> Aluminum Shell, Electroless Nickel Plated	<b>CD</b> Aluminium Shell, Cadmium Plated
	<b>B</b> Aluminium Shell, Black Anodized	<b>P</b> Stainless Steel Shell, Passivated
<b>5 Hardware</b>	<b>O0</b> None, Ø .092 Hole	<b>O1</b> Fixed Jack-posts (STD)
	<b>O2</b> Jackscrews, STD Length, Hex	<b>O3</b> Jackscrews, STD Length, Slotted
	<b>O4</b> Jackscrews, Long Length, Hex	<b>O5</b> Jackscrews, Long Length, Slotted
<b>6 Common Options</b>	<b>HT</b> High Temp Epoxy	<b>RH</b> RoHS Compliant
<b>7 Mod Codes</b>	<b>M10</b> Keyed	<b>M30</b> Ground Spring
	<b>M50</b> Space Grade Micro-D, SPT1	<b>M53</b> Space Grade Micro-D, SPT2
<b>8 Special Instructions</b>	<b>YYY</b> Describe anything that is not covered in standard options	

# LOW PROFILE MICRO-D RIGHT ANGLE THRU-HOLE (TYPE H2)

Omnetics **Low Profile Micro-D Right Angle Thru-Hole** connectors feature a compact .050 inch row spacing reducing the board footprint. These connectors are highly rugged and offer compact board termination designs. Built to meet or exceed the specifications of MIL-DTL-83513.

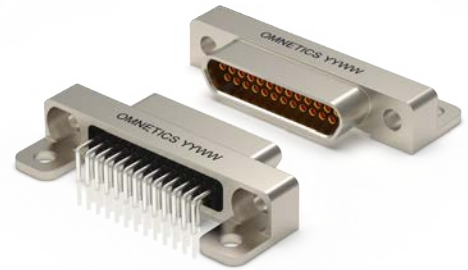

## Electro-Mechanical Specifications

TYPE	PERFORMANCE
Durability	> 2000 Mating Cycles min
Temperature	-55°C to +125°C (200 °C w/HTE)
Current rating	3 Amps per contact per MIL-DTL-83513
Voltage Rating (DWV)	600 VAC RMS Sea Level
Insulation Resistance	5,000 Megohms @ 500 VDC
Shock	50 g's with no discontinuities > 1 microsecond
Vibration	20 g's with no discontinuities > 1 microsecond
Thermal Vacuum Outgassing	1.0% max TML, 0.1% max CVCM - NASA SP-R-0022
Contact Resistance	26 milliohms (65 mV) max @ 2.5 Amps per MIL-DTL-83513
Mating/Unmating Force	3 oz. (.85g) typical per contact

## Material Specifications

TYPE	PERFORMANCE
Contact	Copper Alloy Per MIL-DTL-83513
Contact Finish	Gold per ASTM B488, Type II, Class 1.27, Code C Over Nickel Underplate
Insulator	Thermoplastic per MIL-DTL-83513
Interfacial Seal	Silicone Elastomer per A-A-59588
Hardware	Stainless Steel, 300 Series, Passivated per SAE AMS-2700

## Shell Options

MATERIAL	FINISH
Aluminum 6061	Electroless Nickel per SAE-AMS-2404
Stainless Steel, 300 Series	Passivated per SAE-AMS-2700

# LOW PROFILE MICRO-D RIGHT ANGLE THRU-HOLE (TYPE H2)

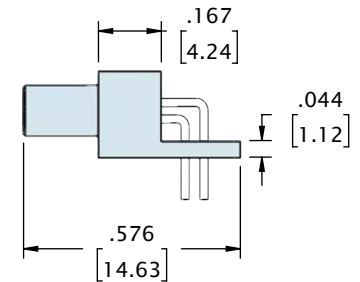
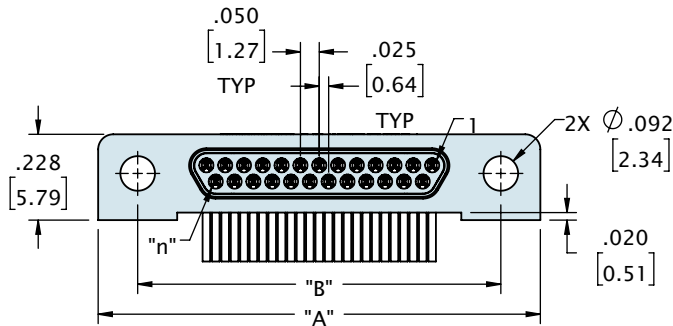
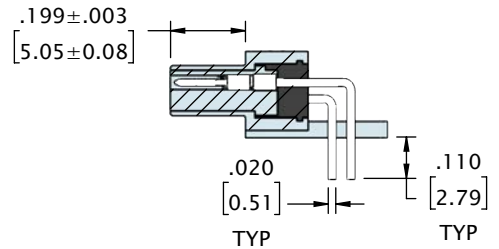
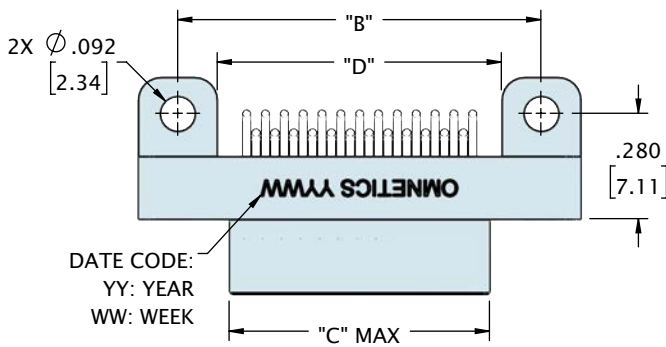

CONTACTS	ROWS	"A"	"B"	"C"	"D"
9	2	.775 [19.69]	.565 [14.35]	.292 [7.42]	.355 [9.02]
15	2	.925 [23.50]	.715 [18.16]	.442 [11.23]	.505 [12.83]
21	2	1.075 [27.31]	.865 [21.97]	.592 [15.04]	.655 [16.64]
25	2	1.175 [29.85]	.965 [24.51]	.692 [17.58]	.755 [19.18]
31	2	1.325 [33.66]	1.115 [28.32]	.842 [21.39]	.905 [22.99]
37	2	1.475 [37.47]	1.265 [32.13]	.992 [25.20]	1.055 [26.80]

DIMENSIONS IN [ ] ARE IN MILLIMETERS AND ARE FOR REFERENCE ONLY

# LOW PROFILE MICRO-D RIGHT ANGLE THRU-HOLE (TYPE H2)

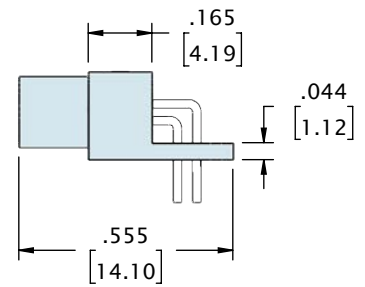
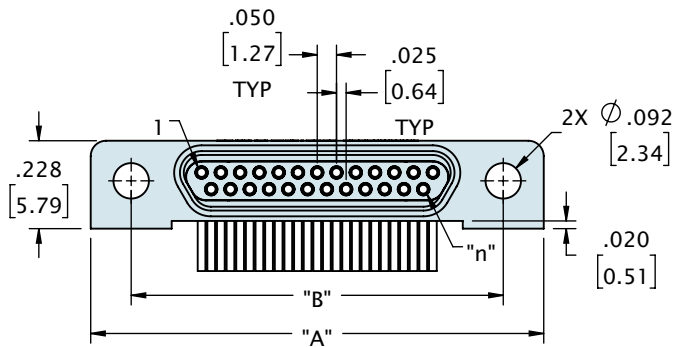
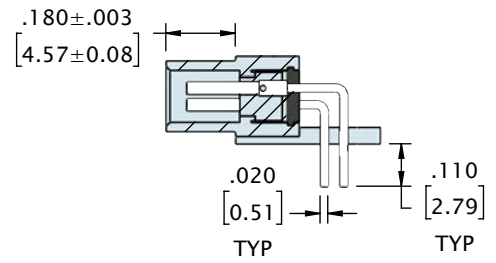
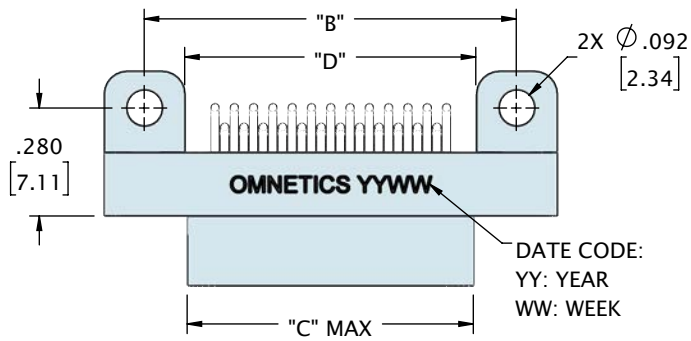

CONTACTS	ROWS	"A"	"B"	"C"	"D"
9	2	.775 [19.69]	.565 [14.35]	.358 [9.09]	.355 [9.02]
15	2	.925 [23.50]	.715 [18.16]	.508 [12.90]	.505 [12.83]
21	2	1.075 [27.31]	.865 [21.97]	.658 [16.71]	.655 [16.64]
25	2	1.175 [29.85]	.965 [24.51]	.758 [19.25]	.755 [19.18]
31	2	1.325 [33.66]	1.115 [28.32]	.908 [23.06]	.905 [22.99]
37	2	1.475 [37.47]	1.265 [32.13]	1.058 [26.87]	1.055 [26.80]

DIMENSIONS IN [ ] ARE IN MILLIMETERS AND ARE FOR REFERENCE ONLY

## ORDERING GUIDE

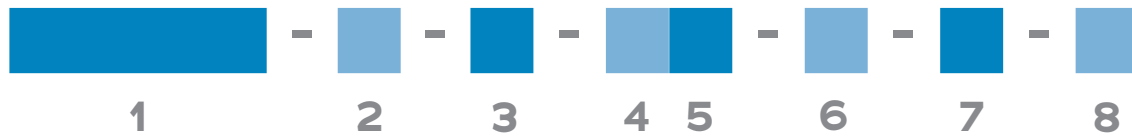

<b>1 Series</b>	<b>MDLP</b> Low Profile Micro-D Pin	<b>MDLS</b> Low Profile Micro-D Socket
<b>2 Number of Contacts</b>	<b>009</b> <b>015</b> <b>021</b> <b>025</b> <b>031</b> <b>037</b>	
<b>3 Termination Type</b>	<b>H2</b> Right Angle Thru-Hole	
<b>4 Shell Material &amp; Finish</b>	<b>N</b> Aluminum Shell, Electroless Nickel Plated	<b>CD</b> Aluminium Shell, Cadmium Plated
	<b>B</b> Aluminium Shell, Black Anodized	<b>P</b> Stainless Steel Shell, Passivated
<b>5 Hardware</b>	<b>00</b> None, Ø .092 Hole	<b>01</b> Fixed Jack-posts (STD)
	<b>02</b> Jackscrews, STD Length, Hex Head	<b>03</b> Jackscrews, STD Length, Slotted
	<b>04</b> Jackscrews, Long Length, Hex	<b>05</b> Jackscrews, Long Length, Slotted
	<b>YY</b> Non Standard Hardware	
<b>6 Common Options</b>	<b>HT</b> High Temp Epoxy	<b>RH</b> RoHS Compliant
<b>7 Mod Codes</b>	<b>M10</b> Keyed	<b>M30</b> Ground Spring
	<b>M50</b> Space Grade Micro-D, SPT1	<b>M53</b> Space Grade Micro-D, SPT2
<b>8 Special Instructions</b>	<b>YYY</b> Describe anything that is not covered in standard options	

# LOW PROFILE MICRO-D RIGHT ANGLE THRU-HOLE (TYPE SR1)

Omnetics helps designers achieve the size, weight, and power (SWaP) priorities of today's compact device design with streamlined **Low Profile Micro-D Right Angle Thru-Hole connectors**. These powerful yet trim connectors are 2.34 mm thinner than a standard Micro-D. Omnetics builds these connectors to meet or exceed the demanding requirements of MIL-DTL-83513. They can endure more than 2,000 mating cycles in operating conditions that include temperate extremes ranging from -55° to 200°C. Available in a range of shell, plating, and pin options to meet an extensive range of harsh-environment systems.



## Electro-Mechanical Specifications

TYPE	PERFORMANCE
Durability	> 2000 Mating Cycles min
Temperature	-55°C to +125°C (200 °C w/HTE)
Current rating	3 Amps per contact per MIL-DTL-83513
Voltage Rating (DWV)	600 VAC RMS Sea Level
Insulation Resistance	5,000 Megohms @ 500 VDC
Shock	50 g's with no discontinuities > 1 microsecond
Vibration	20 g's with no discontinuities > 1 microsecond
Thermal Vacuum Outgassing	1.0% max TML, 0.1% max CVCM - NASA SP-R-0022
Contact Resistance	26 milliohms (65 mV) max @ 2.5 Amps per MIL-DTL-83513
Mating/Unmating Force	3 oz. (.85g) typical per contact

## Material Specifications

TYPE	PERFORMANCE
Contact	Copper Alloy Per MIL-DTL-83513
Contact Finish	Gold per ASTM B488, Type II, Class 1.27, Code C Over Nickel Underplate
Insulator	Thermoplastic per MIL-DTL-83513
Interfacial Seal	Silicone Elastomer per A-A-59588
Hardware	Stainless Steel, 300 Series, Passivated per SAE AMS-2700

## Shell Options

MATERIAL	FINISH
Aluminum 6061	Electroless Nickel per SAE-AMS-2404
Stainless Steel, 300 Series	Passivated per SAE-AMS-2700

# LOW PROFILE MICRO-D RIGHT ANGLE THRU-HOLE (TYPE SR1)

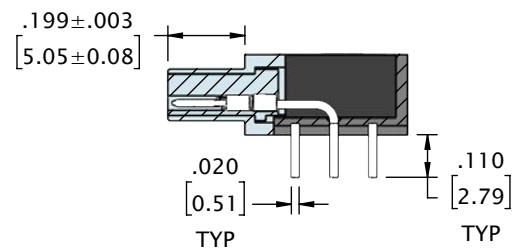
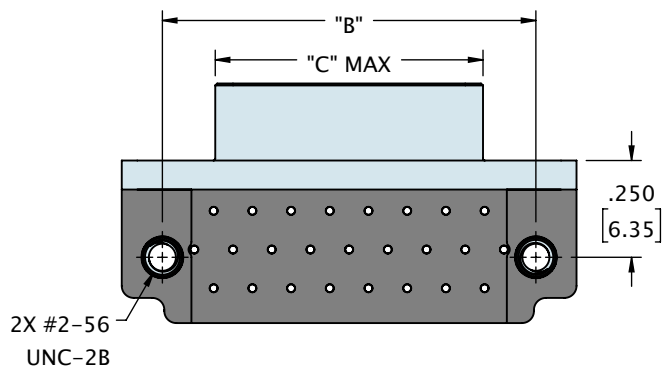
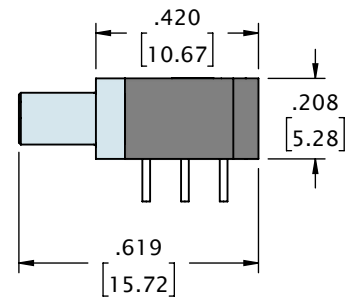
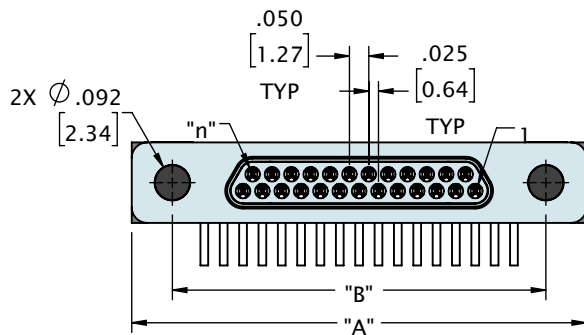
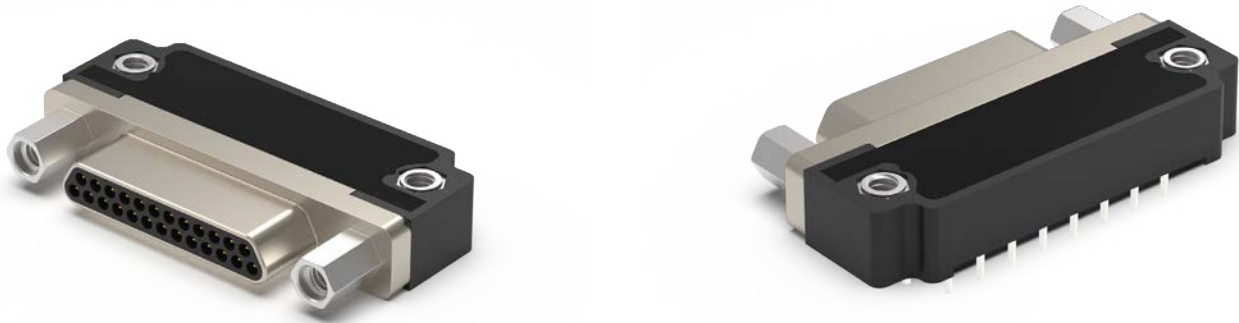

CONTACTS	ROWS	"A"	"B"	"C"
9	2	.775 [19.69]	.565 [14.35]	.292 [7.42]
15	2	.925 [23.50]	.715 [18.16]	.442 [11.23]
21	2	1.075 [27.31]	.865 [21.97]	.592 [15.04]
25	2	1.175 [29.85]	.965 [24.51]	.692 [17.58]
31	2	1.325 [33.66]	1.115 [28.32]	.842 [21.39]
37	2	1.475 [37.47]	1.265 [32.13]	.992 [25.20]

DIMENSIONS IN [ ] ARE IN MILLIMETERS AND ARE FOR REFERENCE ONLY

# LOW PROFILE MICRO-D RIGHT ANGLE THRU-HOLE (TYPE SR1)

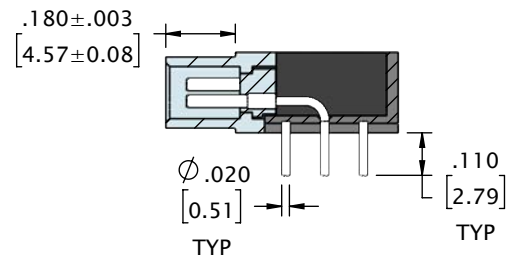
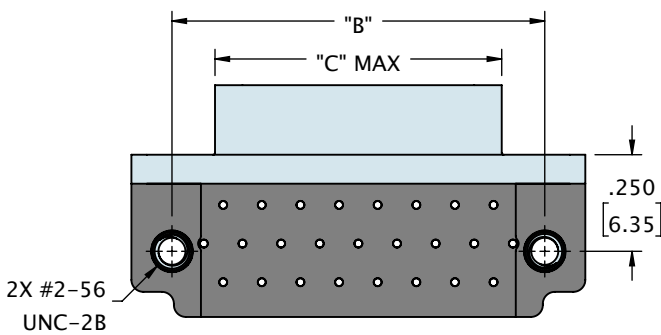
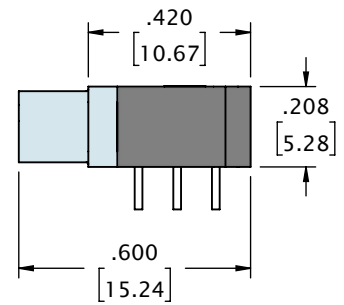
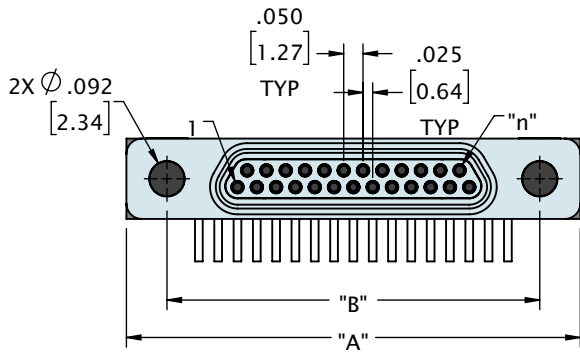
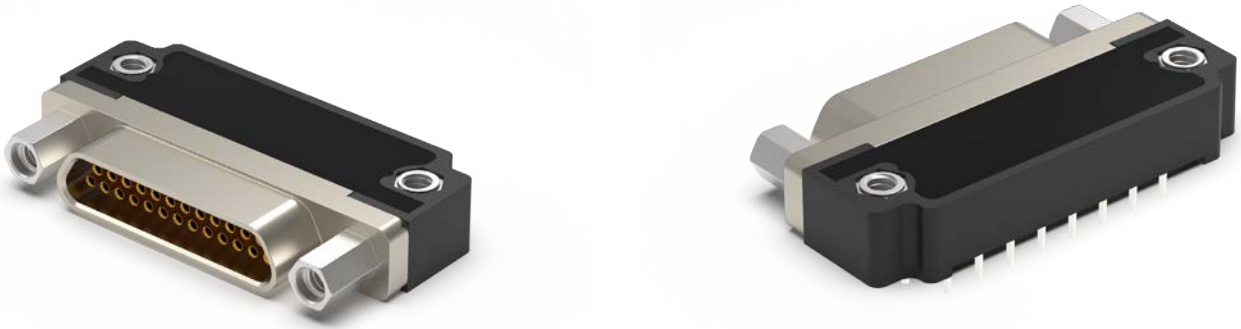

CONTACTS	ROWS	"A"	"B"	"C"
9	2	.775 [19.69]	.565 [14.35]	.358 [9.09]
15	2	.925 [23.50]	.715 [18.16]	.508 [12.90]
21	2	1.075 [27.31]	.865 [21.97]	.658 [16.71]
25	2	1.175 [29.85]	.965 [24.51]	.758 [19.25]
31	2	1.325 [33.66]	1.115 [28.32]	.908 [23.06]
37	2	1.475 [37.47]	1.265 [32.13]	1.058 [26.87]

DIMENSIONS IN [ ] ARE IN MILLIMETERS AND ARE FOR REFERENCE ONLY



## ORDERING GUIDE

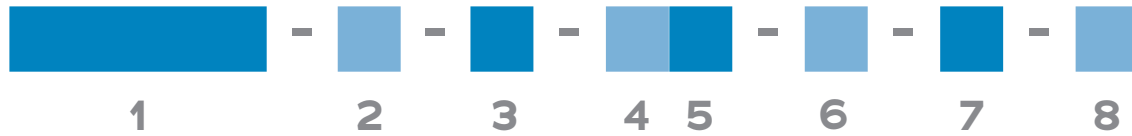

<b>1 Series</b>	<b>MDLP</b> Low Profile Micro-D Pin	<b>MDLS</b> Low Profile Micro-D Socket
<b>2 Number of Contacts</b>	<b>009</b> <b>015</b> <b>021</b> <b>025</b> <b>031</b> <b>037</b>	
<b>3 Termination Type</b>	<b>SR1</b> Right Angle Thru-Hole (spacing at .100)	
<b>4 Shell Material &amp; Finish</b>	<b>N</b> Aluminium Shell, Electroless Nickel Plated <b>B</b> Aluminium Shell, Black Anodized	<b>CD</b> Aluminium Shell, Cadmium Plated <b>P</b> Stainless Steel Shell, Passivated
<b>5 Hardware</b>	<b>00</b> None, Ø .092 Hole	<b>01</b> Fixed Jack-posts (STD)
<b>6 Common Options</b>	<b>ETH</b> End Threaded Hole/Threaded Insert <b>HT</b> High Temp Epoxy	<b>M</b> Plain Mounting Hole <b>RH</b> RoHS Compliant
<b>7 Mod Codes</b>	<b>M10</b> Keyed <b>M50</b> Space Grade Micro-D, SPT1	<b>M30</b> Ground Spring <b>M53</b> Space Grade Micro-D, SPT2
<b>8 Special Instructions</b>	<b>YYY</b> Describe anything that is not covered in standard options	

# SINGLE ROW MICRO-D DISCRETE WIRED (TYPE WD)

Omnetics' **Single Row Micro-D Discrete Leadwire connectors** serve slim and compact applications destined for rugged operating environments. Available with 4 to 37 contacts in a streamlined single row, this tiny connector offers the flexibility of a leadwire cable and the durability needed for the military, aerospace, oil and gas, and medical industries. Omnetics builds these trim, rugged connectors to meet or exceed the demanding requirements of MIL-DTL-83513. They can endure more than 2,000 mating cycles in operating conditions that include temperate extremes ranging from -55° to 200°C. Available in a range of shell, plating, and pin options to meet an extensive range of systems.

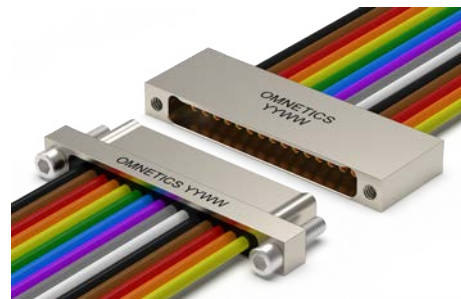

## Electro-Mechanical Specifications

TYPE	PERFORMANCE
Durability	> 2000 Mating Cycles min
Temperature	-55°C to +125°C (200 °C w/HTE)
Current rating	3 Amps per contact per MIL-DTL-83513
Voltage Rating (DWV)	600 VAC RMS Sea Level
Insulation Resistance	5,000 Megohms @ 500 VDC
Shock	50 g's with no discontinuities > 1 microsecond
Vibration	20 g's with no discontinuities > 1 microsecond
Thermal Vacuum Outgassing	1.0% max TML, 0.1% max CVCM - NASA SP-R-0022
Contact Resistance	26 milliohms (65 mV) max @ 2.5 Amps per MIL-DTL-83513
Mating/Unmating Force	3 oz. (.85g) typical per contact

## Material Specifications

TYPE	PERFORMANCE
Contact	Copper Alloy Per MIL-DTL-83513
Contact Finish	Gold per ASTM B488, Type II, Class 1.27, Code C Over Nickel Underplate
Insulator	Thermoplastic per MIL-DTL-83513
Interfacial Seal	Silicone Elastomer per A-A-59588
Hardware	Stainless Steel, 300 Series, Passivated per SAE AMS-2700

## Shell Options

MATERIAL	FINISH
Aluminum 6061	Electroless Nickel per SAE-AMS-2404
Stainless Steel, 300 Series	Passivated per SAE-AMS-2700

# SINGLE ROW MICRO-D DISCRETE WIRED (TYPE WD)

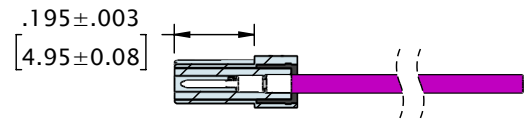
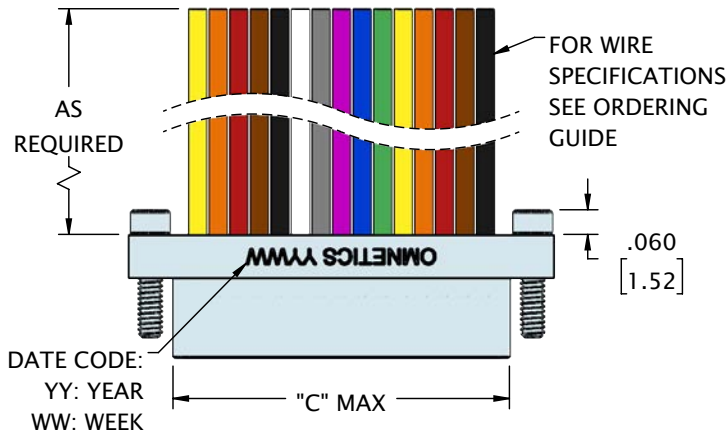
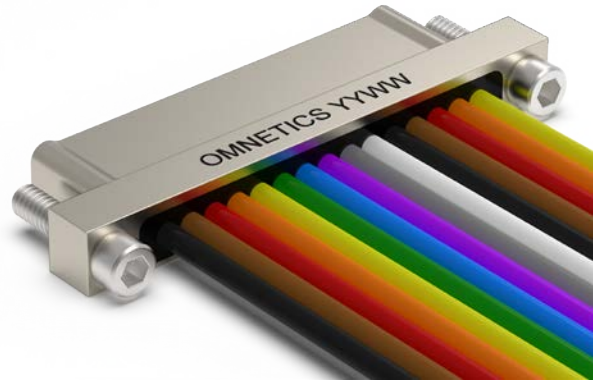

HARDWARE HIDDEN FOR CLARITY

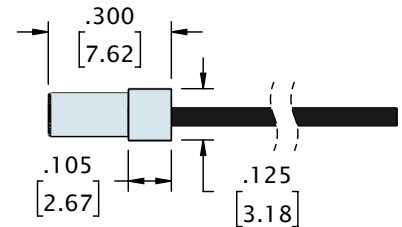
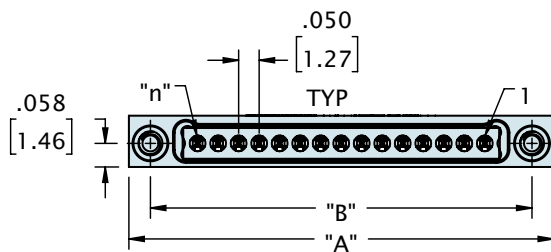

HARDWARE HIDDEN FOR CLARITY

CONTACTS	ROWS	"A"	"B"	"C"
4	1	.485 [12.32]	.380 [9.65]	.270 [6.86]
9	1	.735 [18.67]	.630 [16.00]	.520 [13.21]
15	1	1.035 [26.29]	.930 [23.62]	.820 [20.83]
21	1	1.335 [33.91]	1.230 [31.24]	1.120 [28.45]
25	1	1.535 [38.99]	1.430 [36.32]	1.320 [33.53]
31	1	1.835 [46.61]	1.730 [43.94]	1.620 [41.15]
37	1	2.135 [54.23]	2.030 [51.56]	1.920 [48.77]

DIMENSIONS IN [ ] ARE IN MILLIMETERS AND ARE FOR REFERENCE ONLY

# SINGLE ROW MICRO-D DISCRETE WIRED (TYPE WD)

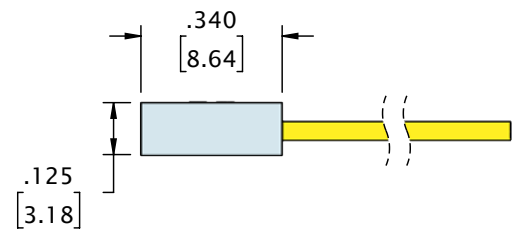
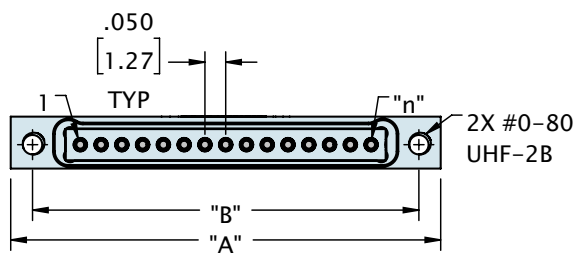
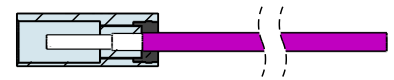
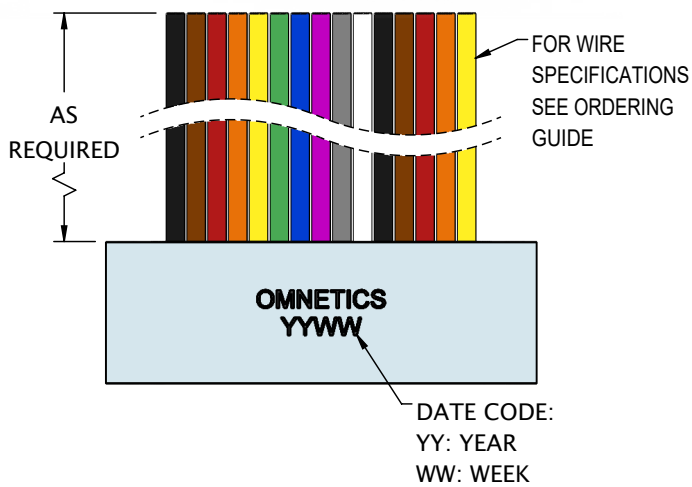

CONTACTS	ROWS	"A"	"B"
4	1	.485 [12.32]	.380 [9.65]
9	1	.735 [18.67]	.630 [16.00]
15	1	1.035 [26.29]	.930 [23.62]
21	1	1.335 [33.91]	1.230 [31.24]
25	1	1.535 [38.99]	1.430 [36.32]
31	1	1.835 [46.61]	1.730 [43.94]
37	1	2.135 [54.23]	2.030 [51.56]

DIMENSIONS IN [ ] ARE IN MILLIMETERS AND ARE FOR REFERENCE ONLY

## ORDERING GUIDE



<b>1 Series</b>	<b>MMSP</b> Metal Micro-D Single Row Pin	<b>MMSS</b> Metal Micro-D Single Row Socket
<b>2 Number of Contacts</b>	<b>04</b> <b>09</b> <b>15</b> <b>21</b> <b>25</b> <b>31</b> <b>37</b>	
<b>3 Termination Type</b>	<b>WD</b> Discrete Leadwire	
<b>4 Wire AWG</b>	<b>4</b> 24 AWG	<b>6</b> 26 AWG (STD) <b>8</b> 28 AWG <b>0</b> 30 AWG
<b>5 Wire Type</b>	<b>Q</b> Nema HP3 (STD)	<b>R</b> M22759/11 <b>S</b> M22759/33 <b>X</b> Other
<b>6 Wire Length (inches)</b>	<b>18.0</b> 18.00 (STD)	<b>XX.X</b> Custom length
<b>7 Color Scheme</b>	<b>1</b> 10 Repeating <b>2</b> Blue <b>3</b> White	<b>4</b> Non Repeating <b>5</b> Yellow
<b>8 Shell Material &amp; Finish</b>	<b>N</b> Aluminum Shell, Electroless Nickel Plated	<b>CD</b> Aluminium Shell, Cadmium Plated
	<b>B</b> Aluminium Shell, Black Anodized	<b>P</b> Stainless Steel Shell, Passivated
<b>9 Hardware</b>	<b>EJS</b> End Jack Screw (MMSP only)	<b>ETH</b> End Threaded Hole (MMSS only)
<b>10 Common Options</b>	<b>HT</b> High Temp Epoxy	<b>RH</b> RoHS Compliant
<b>11 Shield / Jacket</b>	<b>D</b> Slip On Metal Braid <b>E</b> Machine Braid <b>F</b> Flexo Braid	<b>J</b> Nomex Braid <b>ST</b> Shrink Tube
<b>12 Mod Codes</b>	<b>M10</b> Keyed	<b>M30</b> Ground Spring
	<b>M50</b> Space Grade Micro-D, SPT1	<b>M53</b> Space Grade Micro-D, SPT2
<b>13 Special Instructions</b>	<b>YYY</b> Describe anything that is not covered in standard options	

# SINGLE ROW MICRO-D SOLDER CUP (TYPE SS)

Omnetics' Ultra Low Profile Micro-D Solder Cup connectors serve the slim and compact package designs needed for today's rugged applications. They feature Omnetics' gold-plated Flex Pin to protect against shock and vibration in the field. The solder cup option delivers an added element of durability and protection devices designed for the military, aerospace, oil and gas. Omnetics builds these trim, rugged connectors to meet or exceed the demanding requirements of MIL-DTL-83513. Our connectors are designed to endure more than 2,000 mating cycles in operating conditions that include temperate extremes ranging from -55° to 200°C.



## Electro-Mechanical Specifications

TYPE	PERFORMANCE
Durability	> 2000 Mating Cycles min
Temperature	-55°C to +125°C (200 °C w/HTE)
Current rating	3 Amps per contact per MIL-DTL-83513
Voltage Rating (DWV)	600 VAC RMS Sea Level
Insulation Resistance	5,000 Megohms @ 500 VDC
Shock	50 g's with no discontinuities > 1 microsecond
Vibration	20 g's with no discontinuities > 1 microsecond
Thermal Vacuum Outgassing	1.0% max TML, 0.1% max CVCM - NASA SP-R-0022
Contact Resistance	26 milliohms (65 mV) max @ 2.5 Amps per MIL-DTL-83513
Mating/Unmating Force	3 oz. (.85g) typical per contact

## Material Specifications

TYPE	PERFORMANCE
Contact	Copper Alloy Per MIL-DTL-83513
Contact Finish	Gold per ASTM B488, Type II, Class 1.27, Code C Over Nickel Underplate
Insulator	Thermoplastic per MIL-DTL-83513
Interfacial Seal	Silicone Elastomer per A-A-59588
Hardware	Stainless Steel, 300 Series, Passivated per SAE AMS-2700

## Shell Options

MATERIAL	FINISH
Aluminum 6061	Electroless Nickel per SAE-AMS-2404
Stainless Steel, 300 Series	Passivated per SAE-AMS-2700

# SINGLE ROW MICRO-D SOLDER CUP (TYPE SS)

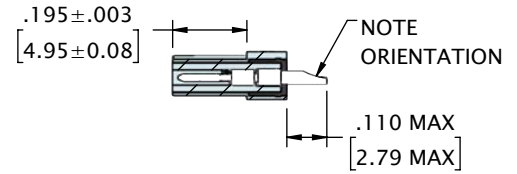
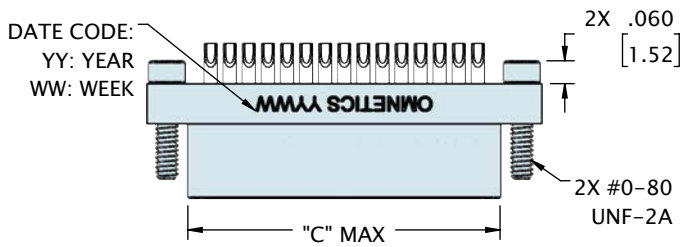

HARDWARE HIDDEN FOR CLARITY

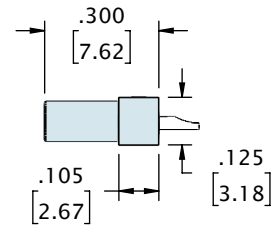
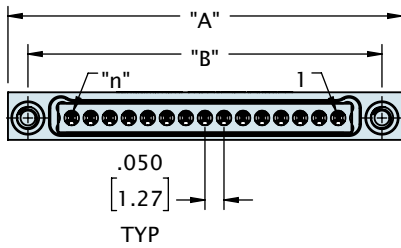

HARDWARE HIDDEN FOR CLARITY

CONTACTS	ROWS	"A"	"B"	"C"
4	1	.485 [12.32]	.380 [9.65]	.270 [6.86]
9	1	.735 [18.67]	.630 [16.00]	.520 [13.21]
15	1	1.035 [26.29]	.930 [23.62]	.820 [20.83]
21	1	1.335 [33.91]	1.230 [31.24]	1.120 [28.45]
25	1	1.535 [38.99]	1.430 [36.32]	1.320 [33.53]
31	1	1.835 [46.61]	1.730 [43.94]	1.620 [41.15]
37	1	2.135 [54.23]	2.030 [51.56]	1.920 [48.77]

DIMENSIONS IN [ ] ARE IN MILLIMETERS AND ARE FOR REFERENCE ONLY

# SINGLE ROW MICRO-D SOLDER CUP (TYPE SS)

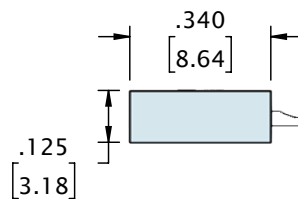
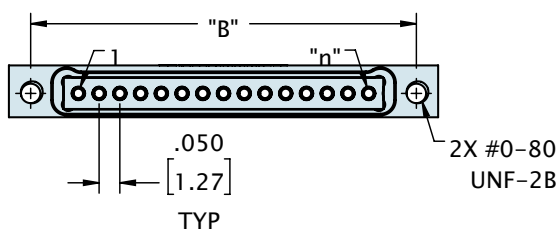
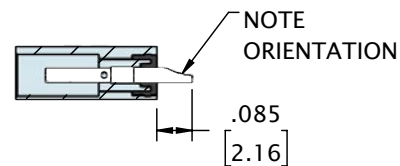
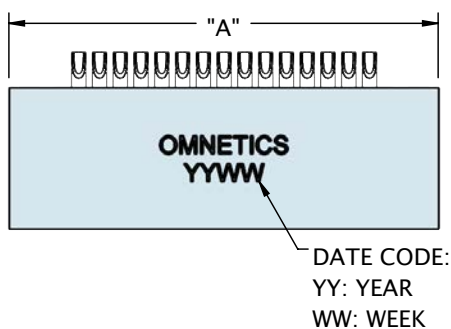
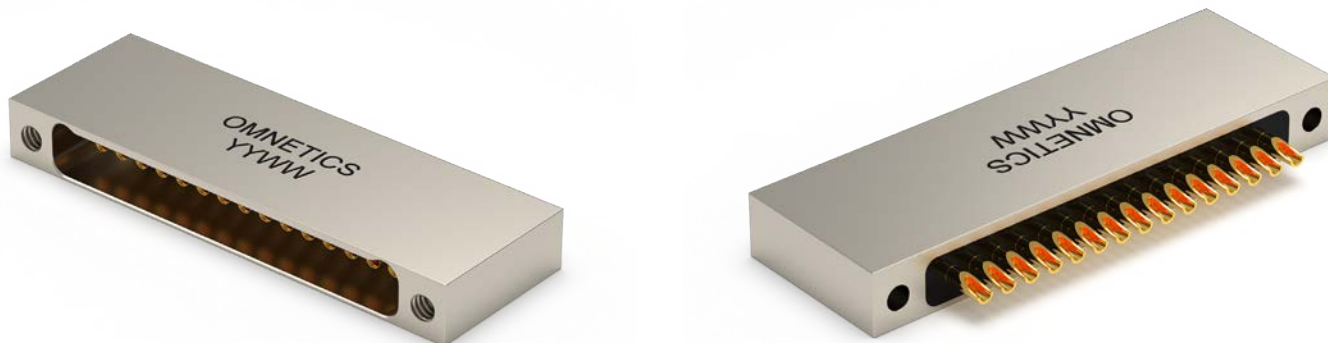

CONTACTS	ROWS	"A"	"B"
4	1	.485 [12.32]	.380 [9.65]
9	1	.735 [18.67]	.630 [16.00]
15	1	1.035 [26.29]	.930 [23.62]
21	1	1.335 [33.91]	1.230 [31.24]
25	1	1.535 [38.99]	1.430 [36.32]
31	1	1.835 [46.61]	1.730 [43.94]
37	1	2.135 [54.23]	2.030 [51.56]

DIMENSIONS IN [ ] ARE IN MILLIMETERS AND ARE FOR REFERENCE ONLY



## ORDERING GUIDE

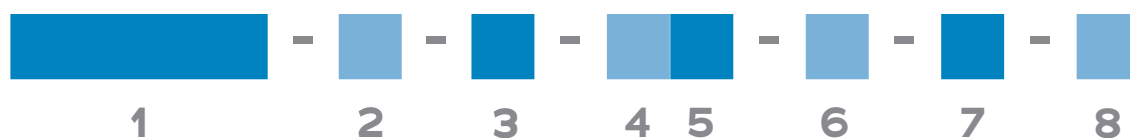

<b>1 Series</b>	<b>MMSP</b> Metal Micro-D Single Row Pin	<b>MMSS</b> Metal Micro-D Single Row Socket
<b>2 Number of Contacts</b>	<b>04</b> <b>09</b> <b>15</b> <b>21</b> <b>25</b> <b>31</b> <b>37</b>	
<b>3 Termination Type</b>	<b>SS</b> Soldercup	
<b>4 Wire AWG</b>	<b>4</b> 24 AWG	<b>6</b> 26 AWG (STD) <b>8</b> 28 AWG <b>0</b> 30 AWG
<b>5 Wire Type</b>	<b>Q</b> Nema HP3 (STD)	<b>R</b> M22759/11 <b>S</b> M22759/33 <b>X</b> Other
<b>6 Wire Length</b>	<b>18.0</b> 18.00 (STD)	<b>XX.X</b> Custom length
<b>7 Color Scheme</b>	<b>1</b> 10 Repeating <b>2</b> Blue <b>3</b> White	<b>4</b> Non Repeating <b>5</b> Yellow
<b>8 Shell Material &amp; Finish</b>	<b>N</b> Aluminum Shell, Electroless Nickel Plated	<b>CD</b> Aluminium Shell, Cadmium Plated
	<b>B</b> Aluminium Shell, Black Anodized	<b>P</b> Stainless Steel Shell, Passivated
<b>9 Hardware</b>	<b>EJS</b> End Jack Screw (MMSP only)	<b>ETH</b> End Threaded Hole (MMSS only)
<b>10 Common Options</b>	<b>HT</b> High Temp Epoxy	<b>RH</b> RoHS Compliant
<b>11 Shield / Jacket</b>	<b>D</b> Slip On Metal Braid <b>E</b> Machine Braid <b>F</b> Flexo Braid	
	<b>J</b> Nomex Braid <b>ST</b> Shrink Tube	
<b>12 Mod Codes</b>	<b>M10</b> Keyed	<b>M30</b> Ground Spring
	<b>M50</b> Space Grade Micro-D, SPT1	<b>M53</b> Space Grade Micro-D, SPT2
<b>13 Special Instructions</b>	<b>YYY</b> Describe anything that is not covered in standard options	

# SINGLE ROW MICRO-D 90° BOARD MOUNT (TYPE AA)

Omnetics' Ultra Low Profile **Micro-D 90° Board Mount connectors** provide precision mating directly on the board in small device designs. This rugged connector serves high-reliability markets such as the military, aerospace, oil and gas, and medical industries. Omnetics' Flex Pin design delivers additional protection against shock and vibration in harsh operating environments. Our connectors meet or exceed the demanding requirements of MIL-DTL-83513. Omnetics engineers this product to endure more than 2,000 mating cycles in operating conditions that include temperate extremes ranging from -55° to 200°C.



## Electro-Mechanical Specifications

TYPE	PERFORMANCE
Durability	> 2000 Mating Cycles min
Temperature	-55°C to +125°C (200 °C w/HTE)
Current rating	3 Amps per contact per MIL-DTL-83513
Voltage Rating (DWV)	600 VAC RMS Sea Level
Insulation Resistance	5,000 Megohms @ 500 VDC
Shock	50 g's with no discontinuities > 1 microsecond
Vibration	20 g's with no discontinuities > 1 microsecond
Thermal Vacuum Outgassing	1.0% max TML, 0.1% max CVCM - NASA SP-R-0022
Contact Resistance	26 milliohms (65 mV) max @ 2.5 Amps per MIL-DTL-83513
Mating/Unmating Force	3 oz. (.85g) typical per contact

## Material Specifications

TYPE	PERFORMANCE
Contact	Copper Alloy Per MIL-DTL-83513
Contact Finish	Gold per ASTM B488, Type II, Class 1.27, Code C Over Nickel Underplate
Insulator	Thermoplastic per MIL-DTL-83513
Interfacial Seal	Silicone Elastomer per A-A-59588
Hardware	Stainless Steel, 300 Series, Passivated per SAE AMS-2700

## Shell Options

MATERIAL	FINISH
Aluminum 6061	Electroless Nickel per SAE-AMS-2404
Stainless Steel, 300 Series	Passivated per SAE-AMS-2700

# SINGLE ROW MICRO-D 90° BOARD MOUNT (TYPE AA)

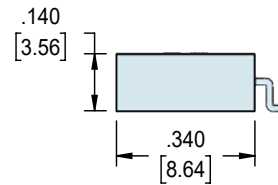
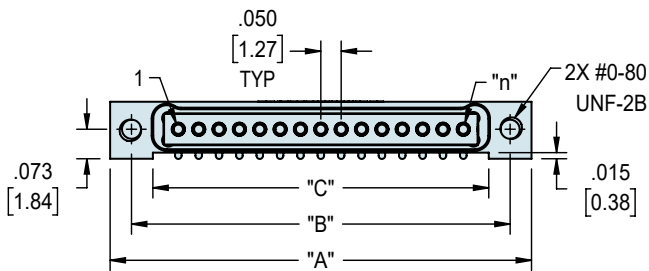
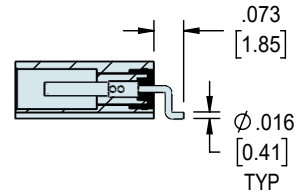
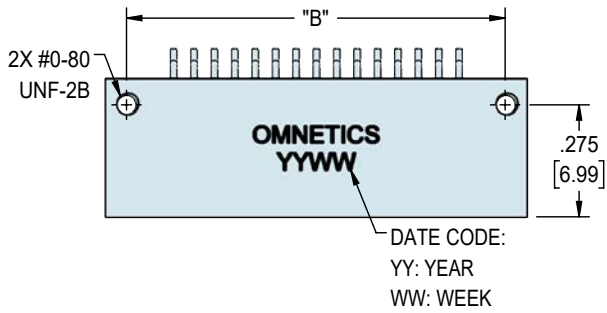

CONTACTS	ROWS	"A"	"B"	"C"
4	1	.485 [12.32]	.380 [9.65]	.275 [6.99]
9	1	.735 [18.67]	.630 [16.00]	.525 [13.34]
15	1	1.035 [26.29]	.930 [23.62]	.825 [20.96]
21	1	1.335 [33.91]	1.230 [31.24]	1.125 [28.58]
25	1	1.535 [38.99]	1.430 [36.32]	1.325 [33.66]
31	1	1.835 [46.61]	1.730 [43.94]	1.625 [41.28]
37	1	2.135 [54.23]	2.030 [51.56]	1.925 [48.90]

DIMENSIONS IN [ ] ARE IN MILLIMETERS AND ARE FOR REFERENCE ONLY

*This page intentionally left blank.*

## ORDERING GUIDE

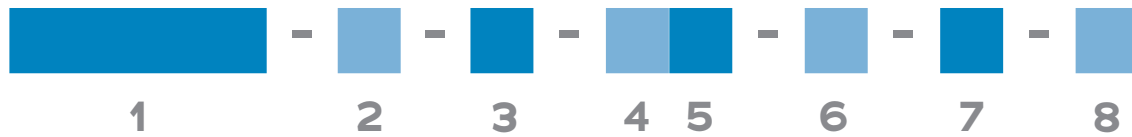

<b>1 Series</b>	MMSS Metal Micro-D Single Row Socket				
<b>2 Number of Contacts</b>	O4	O9	15	21	25 31 37
<b>3 Termination Type</b>	AA 90° Board Mount				
<b>4 Wire AWG</b>	4 24 AWG		6 26 AWG (STD)		8 28 AWG    O 30 AWG
<b>5 Wire Type</b>	Q Nema HP3 (STD)		R M22759/11		S M22759/33    X Other
<b>6 Wire Length</b>	18.O 18.00 (STD)			XX.X Custom length	
<b>7 Color Scheme</b>	1 10 Repeating		2 Blue	3 White	4 Non Repeating    5 Yellow
<b>8 Shell Material &amp; Finish</b>	N Aluminum Shell, Electroless Nickel Plated			CD Aluminium Shell, Cadmium Plated	
	B Aluminium Shell, Black Anodized			P Stainless Steel Shell, Passivated	
<b>9 Hardware</b>	EJS End Jack Screw (MMSP only)			ETH End Threaded Hole (MMSS only)	
<b>10 Common Options</b>	HT High Temp Epoxy			RH RoHS Compliant	
<b>11 Shield / Jacket</b>	D Slip On Metal Braid		E Machine Braid	F Flexo Braid	
	J Nomex Braid		ST Shrink Tube		
<b>12 Mod Codes</b>	M10 Keyed			M30 Ground Spring	
	M50 Space Grade Micro-D, SPT1			M53 Space Grade Micro-D, SPT2	
<b>13 Special Instructions</b>	YYY Describe anything that is not covered in standard options				

# SINGLE ROW MICRO-D STRAIGHT THRU-HOLE (TYPE DD)

Omnetics' **Single Row Micro-D Straight Tail connectors** provide a trim and streamlined interconnect for rugged, low-profile system designs. Omnetics' Flex Pin design absorbs shock and vibration, enabling small devices to endure the rigors of the field without loss of integrity. Our trim, rugged connectors meet or exceed the demanding requirements of MIL-DTL-83513. They can endure more than 2,000 mating cycles in operating conditions that include temperate extremes ranging from -55° to 200°C. Available in a range of shell, plating, and pin options to meet an extensive range of systems.



## Electro-Mechanical Specifications

TYPE	PERFORMANCE
Durability	> 2000 Mating Cycles min
Temperature	-55°C to +125°C (200 °C w/HTE)
Current rating	3 Amps per contact per MIL-DTL-83513
Voltage Rating (DWV)	600 VAC RMS Sea Level
Insulation Resistance	5,000 Megohms @ 500 VDC
Shock	50 g's with no discontinuities > 1 microsecond
Vibration	20 g's with no discontinuities > 1 microsecond
Thermal Vacuum Outgassing	1.0% max TML, 0.1% max CVCM - NASA SP-R-0022
Contact Resistance	26 milliohms (65 mV) max @ 2.5 Amps per MIL-DTL-83513
Mating/Unmating Force	3 oz. (.85g) typical per contact

## Material Specifications

TYPE	PERFORMANCE
Contact	Copper Alloy Per MIL-DTL-83513
Contact Finish	Gold per ASTM B488, Type II, Class 1.27, Code C Over Nickel Underplate
Insulator	Thermoplastic per MIL-DTL-83513
Interfacial Seal	Silicone Elastomer per A-A-59588
Hardware	Stainless Steel, 300 Series, Passivated per SAE AMS-2700

## Shell Options

MATERIAL	FINISH
Aluminum 6061	Electroless Nickel per SAE-AMS-2404
Stainless Steel, 300 Series	Passivated per SAE-AMS-2700

# SINGLE ROW MICRO-D STRAIGHT THRU-HOLE (TYPE DD)

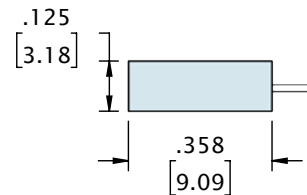
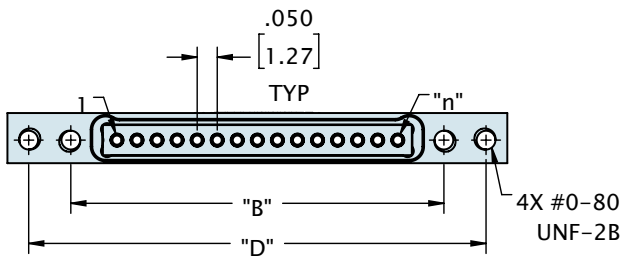
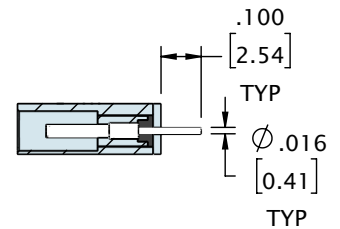
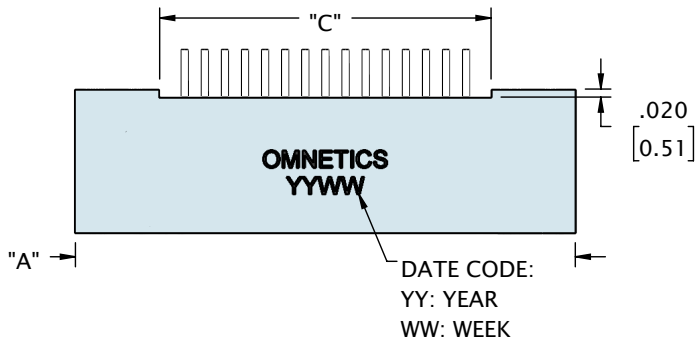
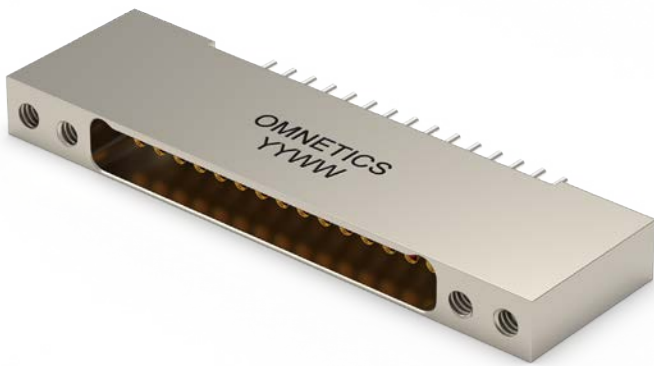

CONTACTS	ROWS	"A"	"B"	"C"	"D"
4	1	.696 [17.68]	.380 [9.65]	.276 [7.01]	.590 [14.99]
9	1	.946 [24.03]	.630 [16.00]	.526 [13.36]	.840 [21.34]
15	1	1.246 [31.65]	.930 [23.62]	.826 [20.98]	1.140 [28.96]
21	1	1.546 [39.27]	1.230 [31.24]	1.126 [28.60]	1.440 [36.58]
25	1	1.746 [44.35]	1.430 [36.32]	1.326 [33.68]	1.640 [41.66]
31	1	2.046 [51.97]	1.730 [43.94]	1.626 [41.30]	1.940 [49.28]
37	1	2.346 [59.59]	2.030 [51.56]	1.926 [48.92]	2.240 [56.90]

DIMENSIONS IN [ ] ARE IN MILLIMETERS AND ARE FOR REFERENCE ONLY

*This page intentionally left blank.*



## ORDERING GUIDE

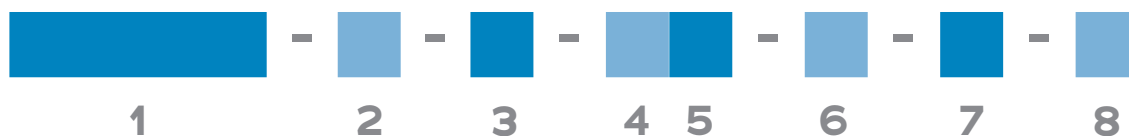

<b>1 Series</b>	MMSS Metal Micro-D Single Row Socket						
<b>2 Number of Contacts</b>	O4	O9	15	21	25	31	37
<b>3 Termination Type</b>	DD Straight Thru-Hole						
<b>4 Wire AWG</b>	4 24 AWG		6 26 AWG (STD)		8 28 AWG		O 30 AWG
<b>5 Wire Type</b>	Q Nema HP3 (STD)		R M22759/11		S M22759/33		X Other
<b>6 Wire Length</b>	18.0 18.00 (STD)			XX.X Custom length			
<b>7 Color Scheme</b>	1 10 Repeating		2 Blue	3 White	4 Non Repeating		5 Yellow
<b>8 Shell Material &amp; Finish</b>	N Aluminum Shell, Electroless Nickel Plated			CD Aluminium Shell, Cadmium Plated			
	B Aluminium Shell, Black Anodized			P Stainless Steel Shell, Passivated			
<b>9 Hardware</b>	EJS End Jack Screw (MMSP only)			ETH End Threaded Hole (MMSS only)			
<b>10 Common Options</b>	HT High Temp Epoxy			RH RoHS Compliant			
<b>11 Shield / Jacket</b>	D Slip On Metal Braid	E Machine Braid		F Flexo Braid			
	J Nomex Braid		ST Shrink Tube				
<b>12 Mod Codes</b>	M10 Keyed			M30 Ground Spring			
	M50 Space Grade Micro-D, SPT1			M53 Space Grade Micro-D, SPT2			
<b>13 Special Instructions</b>	YYY Describe anything that is not covered in standard options						

# SINGLE ROW MICRO-D THRU-HOLE HORIZONTAL (TYPE H2)

Omnetics' **Single Row Micro-D Thru-Hole Horizontal connectors** are a very slim interconnect for small and low-profile system designs. Our thru-hole connector serves high-reliability applications for the military, aerospace, oil and gas, and medical industries. Omnetics' integrated Flex Pin design helps small devices absorb shock and vibration without loss of integrity in rugged field conditions. Our connectors meet or exceed the demanding requirements of MIL-DTL-83513. They can endure more than 2,000 mating cycles in operating conditions that include temperate extremes ranging from -55° to 200°C. Available in a range of shell, plating, and pin options to meet an extensive range of systems.



## Electro-Mechanical Specifications

TYPE	PERFORMANCE
Durability	> 2000 Mating Cycles min
Temperature	-55°C to +125°C (200 °C w/HTE)
Current rating	3 Amps per contact per MIL-DTL-83513
Voltage Rating (DWV)	600 VAC RMS Sea Level
Insulation Resistance	5,000 Megohms @ 500 VDC
Shock	50 g's with no discontinuities > 1 microsecond
Vibration	20 g's with no discontinuities > 1 microsecond
Thermal Vacuum Outgassing	1.0% max TML, 0.1% max CVCM - NASA SP-R-0022
Contact Resistance	26 milliohms (65 mV) max @ 2.5 Amps per MIL-DTL-83513
Mating/Unmating Force	3 oz. (.85g) typical per contact

## Material Specifications

TYPE	PERFORMANCE
Contact	Copper Alloy Per MIL-DTL-83513
Contact Finish	Gold per ASTM B488, Type II, Class 1.27, Code C Over Nickel Underplate
Insulator	Thermoplastic per MIL-DTL-83513
Interfacial Seal	Silicone Elastomer per A-A-59588
Hardware	Stainless Steel, 300 Series, Passivated per SAE AMS-2700

## Shell Options

MATERIAL	FINISH
Aluminum 6061	Electroless Nickel per SAE-AMS-2404
Stainless Steel, 300 Series	Passivated per SAE-AMS-2700

# SINGLE ROW MICRO-D THRU-HOLE HORIZONTAL (TYPE H2)

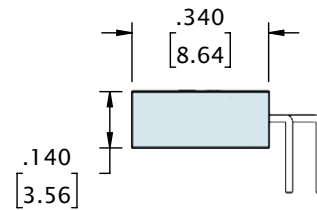
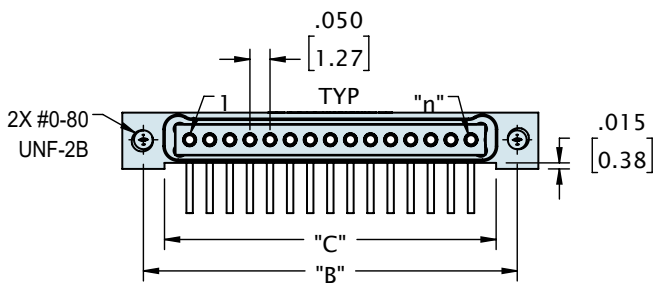
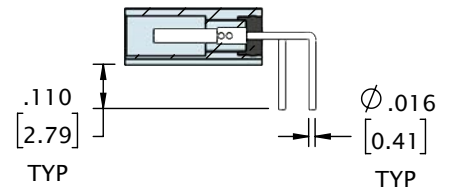
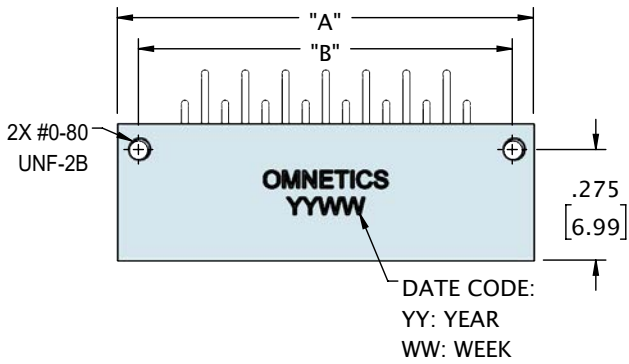
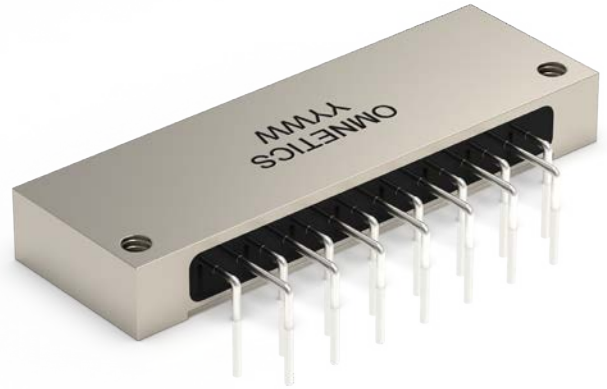

CONTACTS	ROWS	"A"	"B"	"C"
4	1	.485 [12.32]	.380 [9.65]	.275 [6.99]
9	1	.735 [18.67]	.630 [16.00]	.525 [13.34]
15	1	1.035 [26.29]	.930 [23.62]	.825 [20.96]
21	1	1.335 [33.91]	1.230 [31.24]	1.125 [28.58]
25	1	1.535 [38.99]	1.430 [36.32]	1.325 [33.66]
31	1	1.835 [46.61]	1.730 [43.94]	1.625 [41.28]
37	1	2.135 [54.23]	2.030 [51.56]	1.925 [48.90]

DIMENSIONS IN [ ] ARE IN MILLIMETERS AND ARE FOR REFERENCE ONLY

*This page intentionally left blank.*

## ORDERING GUIDE

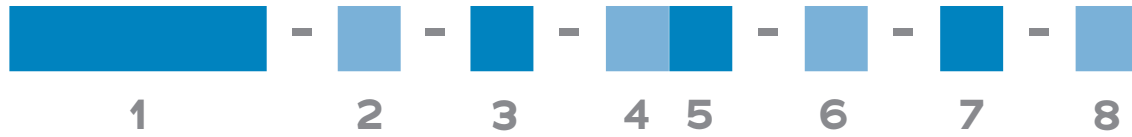

<b>1 Series</b>	MMSS Metal Micro-D Single Row Socket				
<b>2 Number of Contacts</b>	04	09	15	21	25 31 37
<b>3 Termination Type</b>	H2 Thru-Hole Horizontal				
<b>4 Wire AWG</b>	4 24 AWG		6 26 AWG (STD)		8 28 AWG 0 30 AWG
<b>5 Wire Type</b>	Q Nema HP3 (STD)		R M22759/11		S M22759/33 X Other
<b>6 Wire Length</b>	18.0 18.00 (STD)			XX.X Custom length	
<b>7 Color Scheme</b>	1 10 Repeating		2 Blue	3 White	4 Non Repeating 5 Yellow
<b>8 Shell Material &amp; Finish</b>	N Aluminum Shell, Electroless Nickel Plated			CD Aluminium Shell, Cadmium Plated	
	B Aluminium Shell, Black Anodized			P Stainless Steel Shell, Passivated	
<b>9 Hardware</b>	EJS End Jack Screw (MMSP only)			ETH End Threaded Hole (MMSS only)	
<b>10 Common Options</b>	HT High Temp Epoxy			RH RoHS Compliant	
<b>11 Shield / Jacket</b>	D Slip On Metal Braid		E Machine Braid	F Flexo Braid	
	J Nomex Braid		ST Shrink Tube		
<b>12 Mod Codes</b>	M10 Keyed			M30 Ground Spring	
	M50 Space Grade Micro-D, SPT1			M53 Space Grade Micro-D, SPT2	
<b>13 Special Instructions</b>	YYY Describe anything that is not covered in standard options				

# LATCHING MICRO-D DISCRETE LEADWIRE (TYPE WD)

Omnetics' **Latching Micro-D connectors** offer a rugged quick latch system. The Latching Micro-D connectors are available in sizes 9-51 and use Omnetics' Flex Pin contact system, which meets all the standard performance requirements of MIL-DTL-83513, including shock and vibration. These connectors provide a secure connection without the need for tools and jacking hardware and are available in wired, board mount, panel mount configurations as well as with back shell options.



## Electro-Mechanical Specifications

TYPE	PERFORMANCE
Durability	> 2000 Mating Cycles min
Temperature	-55°C to +125°C (200 °C w/HTE)
Current rating	3 Amps per contact per MIL-DTL-83513
Voltage Rating (DWV)	600 VAC RMS Sea Level
Insulation Resistance	5,000 Megohms @ 500 VDC
Shock	50 g's with no discontinuities > 1 microsecond
Vibration	20 g's with no discontinuities > 1 microsecond
Thermal Vacuum Outgassing	1.0% max TML, 0.1% max CVCM - NASA SP-R-0022
Contact Resistance	26 milliohms (65 mV) max @ 2.5 Amps per MIL-DTL-83513
Mating/Unmating Force	3 oz. (.85g) typical per contact

## Material Specifications

TYPE	PERFORMANCE
Contact	Copper Alloy Per MIL-DTL-83513
Contact Finish	Gold per ASTM B488, Type II, Class 1.27, Code C Over Nickel Underplate
Insulator	Thermoplastic per MIL-DTL-83513
Interfacial Seal	Silicone Elastomer per A-A-59588
Hardware	Stainless Steel, 300 Series, Passivated per SAE AMS-2700

## Shell Options

MATERIAL	FINISH
Aluminum 6061	Electroless Nickel per SAE-AMS-2404
Stainless Steel, 300 Series	Passivated per SAE-AMS-2700

# LATCHING MICRO-D DISCRETE LEADWIRE (TYPE WD)

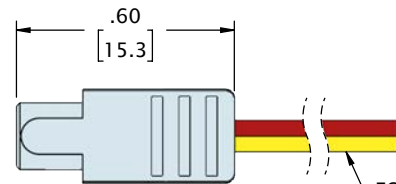
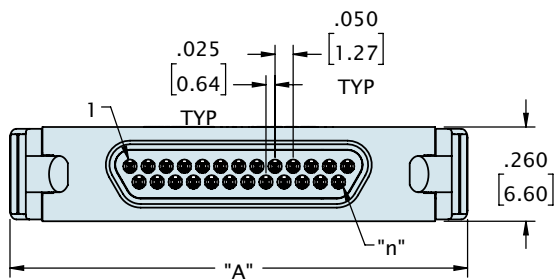
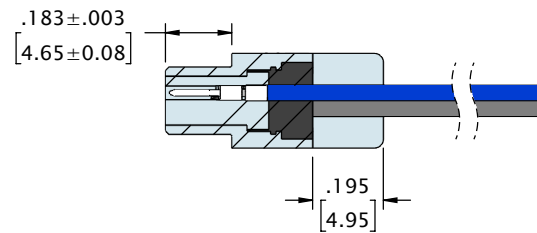
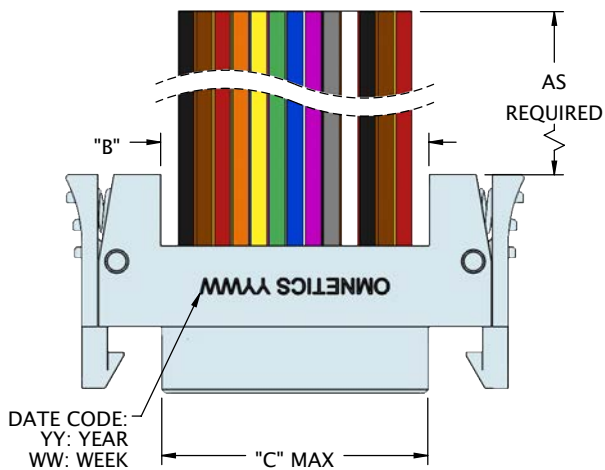
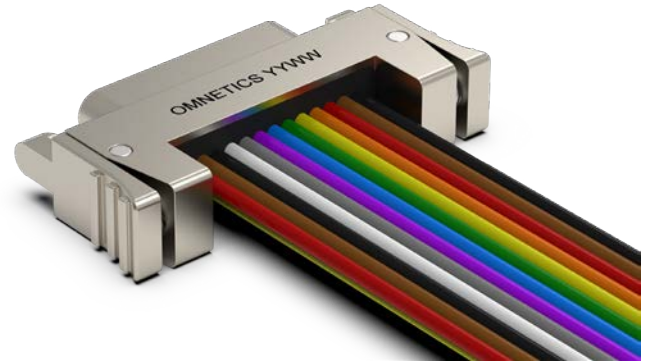

FOR WIRE SPECIFICATIONS, SEE ORDERING GUIDE

CONTACTS	ROWS	"A"	"B"	"C"
9	2	.86 [21.8]	.340 [8.64]	.334 [8.48]
15	2	1.01 [25.7]	.490 [12.45]	.484 [12.29]
21	2	1.16 [29.5]	.640 [16.26]	.634 [16.10]
25	2	1.26 [32.0]	.740 [18.80]	.734 [18.64]
31	2	1.41 [35.8]	.890 [22.61]	.884 [22.45]
37	2	1.56 [39.6]	1.040 [26.42]	1.034 [26.26]
51	2	1.91 [48.5]	1.390 [35.31]	1.384 [35.15]

DIMENSIONS IN [ ] ARE IN MILLIMETERS AND ARE FOR REFERENCE ONLY

# LATCHING MICRO-D DISCRETE LEADWIRE (TYPE WD)

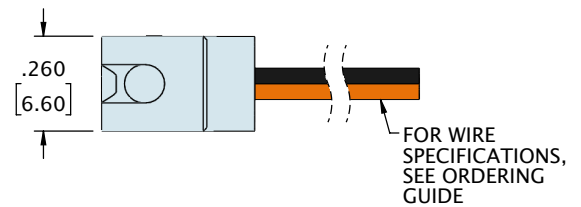
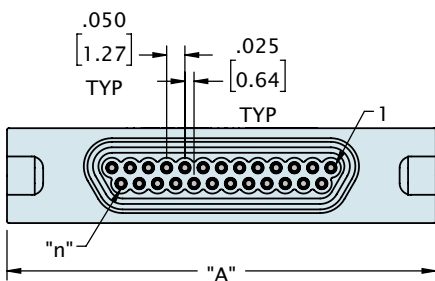
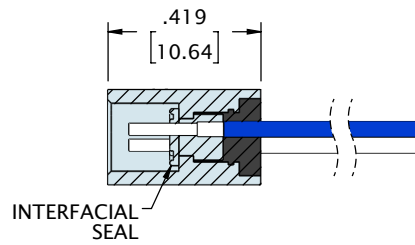
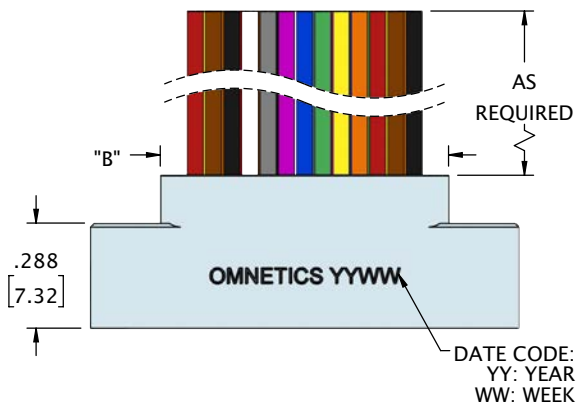
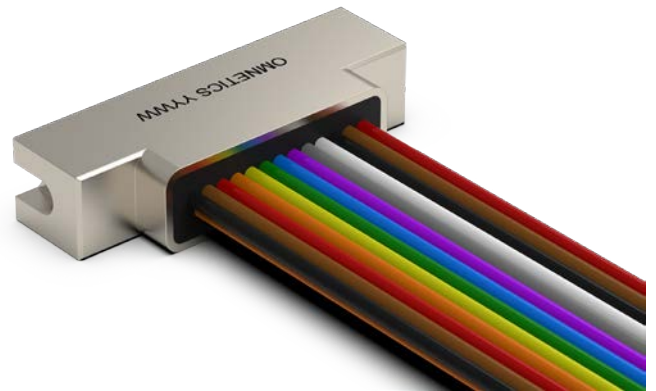
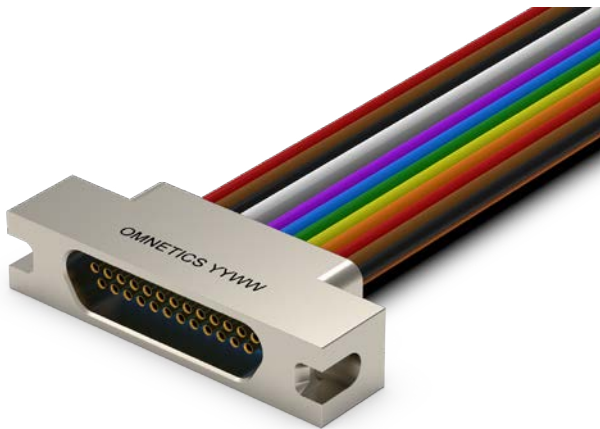

CONTACTS	ROWS	"A"	"B"
9	2	.775 [19.69]	.390 [9.91]
15	2	.925 [23.50]	.540 [13.72]
21	2	1.075 [27.31]	.690 [17.53]
25	2	1.175 [29.85]	.790 [20.07]
31	2	1.325 [33.66]	.940 [23.88]
37	2	1.475 [37.47]	1.090 [27.69]
51	2	1.825 [46.36]	1.440 [36.58]

DIMENSIONS IN [ ] ARE IN MILLIMETERS AND ARE FOR REFERENCE ONLY



## ORDERING GUIDE

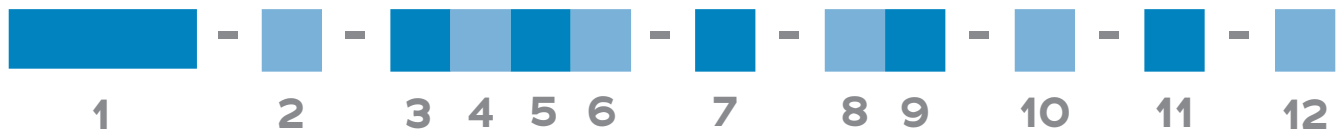

<b>1 Series</b>	<b>LMDP</b> Latching Metal Micro-D Pin LMDP - Latch Side (STD)	<b>LMDS</b> Latching Metal Micro-D Socket LMDS - Latch Receptacle side (STD)
<b>2 Number of Contacts</b>	<b>009</b> <b>015</b> <b>021</b> <b>025</b> <b>031</b> <b>037</b> <b>051</b> *	
* Use <b>512</b> for Two Rows <b>051</b>		
<b>3 Termination Type</b>	<b>WD</b> Discrete Leadwire	
<b>4 Wire AWG</b>	<b>4</b> 24 AWG <b>6</b> 26 AWG (STD)	<b>8</b> 28 AWG <b>0</b> 30 AWG
<b>5 Wire Type</b>	<b>Q</b> Nema HP3 (STD) <b>R</b> M22759/11	<b>S</b> M22759/33 <b>X</b> Other
<b>6 Wire Length (inches)</b>	<b>18.0</b> 18.00 (STD)	<b>XX.X</b> Custom length
<b>7 Color Scheme</b>	<b>1</b> 10 Repeating <b>2</b> Blue <b>3</b> White	<b>4</b> Non Repeating <b>5</b> Yellow
<b>8 Shell Material &amp; Finish</b>	<b>N</b> Aluminum Shell, Electroless Nickel Plated <b>B</b> Aluminium Shell, Black Anodized	<b>CD</b> Aluminium Shell, Cadmium Plated <b>P</b> Stainless Steel Shell, Passivated
<b>9 Common Options</b>	<b>PA</b> Panel Mount Rear, O-Ring <b>IBS</b> Integrated Backshel <b>HT</b> High Temp Epoxy	<b>PB</b> Panel Mount, Rear <b>BSY</b> Custom Backshell <b>RH</b> RoHS Compliant
<b>10 Shield / Jacket</b>	<b>D</b> Slip On Metal Braid <b>E</b> Machine Braid <b>F</b> Flexo Braid <b>J</b> Nomex Braid <b>ST</b> Shrink Tube	
<b>11 Mod Code</b>	<b>M10</b> Keyed <b>M30</b> Ground Spring <b>M50</b> Space Grade Micro-D, SPT1 <b>M53</b> Space Grade Micro-D, SPT2	
<b>12 Special Instructions</b>	<b>YYY</b> Describe anything that is not covered in standard options	

# LATCHING MICRO-D SOLDER CUP (TYPE SS)

Achieve a highly stable and secure connection for Micro-D terminations with Omnetics' rugged **Latching Solder Cup Micro-D connectors**. This shell configuration provides exceptional reliability for critical applications in the aerospace, military, oil and gas, medical, and other industries. Omnetics builds these rugged connectors to meet or exceed the demanding requirements of MIL-DTL-83513. They can endure more than 2,000 mating cycles in operating conditions that include temperate extremes ranging from -55° to 200°C. Available in a range of shell, plating, and pin options to serve an extensive range of systems.



## Electro-Mechanical Specifications

TYPE	PERFORMANCE
Durability	> 2000 Mating Cycles min
Temperature	-55°C to +125°C (200 °C w/HTE)
Current rating	3 Amps per contact per MIL-DTL-83513
Voltage Rating (DWV)	600 VAC RMS Sea Level
Insulation Resistance	5,000 Megohms @ 500 VDC
Shock	50 g's with no discontinuities > 1 microsecond
Vibration	20 g's with no discontinuities > 1 microsecond
Thermal Vacuum Outgassing	1.0% max TML, 0.1% max CVCM - NASA SP-R-0022
Contact Resistance	26 milliohms (65 mV) max @ 2.5 Amps per MIL-DTL-83513
Mating/Unmating Force	3 oz. (.85g) typical per contact

## Material Specifications

TYPE	PERFORMANCE
Contact	Copper Alloy Per MIL-DTL-83513
Contact Finish	Gold per ASTM B488, Type II, Class 1.27, Code C Over Nickel Underplate
Insulator	Thermoplastic per MIL-DTL-83513
Interfacial Seal	Silicone Elastomer per A-A-59588
Hardware	Stainless Steel, 300 Series, Passivated per SAE AMS-2700

## Shell Options

MATERIAL	FINISH
Aluminum 6061	Electroless Nickel per SAE-AMS-2404
Stainless Steel, 300 Series	Passivated per SAE-AMS-2700

# LATCHING MICRO-D SOLDER CUP (TYPE SS)

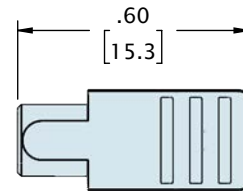
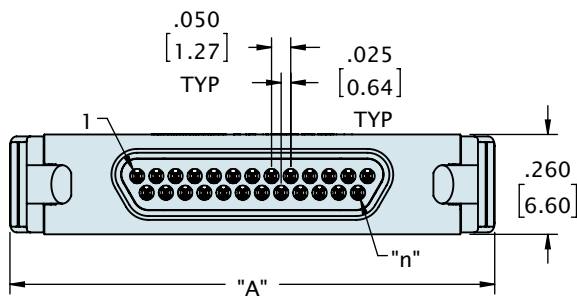
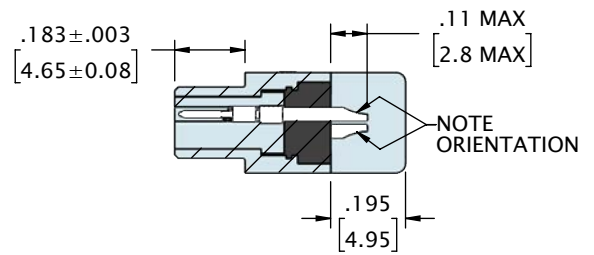
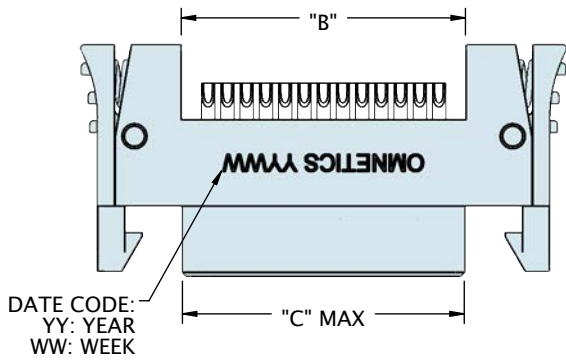
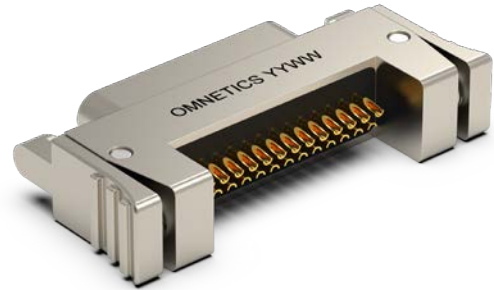

CONTACTS	ROWS	"A"	"B"	"C"
9	2	.86 [21.8]	.340 8.636	.334 [8.48]
15	2	1.01 [25.7]	.490 12.446	.484 [12.29]
21	2	1.16 [29.5]	.640 16.256	.634 [16.10]
25	2	1.26 [32.0]	.740 18.796	.734 [18.64]
31	2	1.41 [35.8]	.890 22.606	.884 [22.45]
37	2	1.56 [39.6]	1.040 26.416	1.034 [26.26]
51	2	1.91 [48.5]	1.390 35.306	1.384 [35.15]

DIMENSIONS IN [ ] ARE IN MILLIMETERS AND ARE FOR REFERENCE ONLY

# LATCHING MICRO-D SOLDER CUP (TYPE SS)

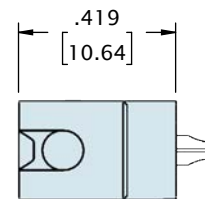
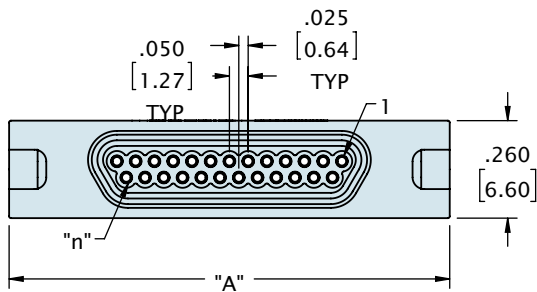
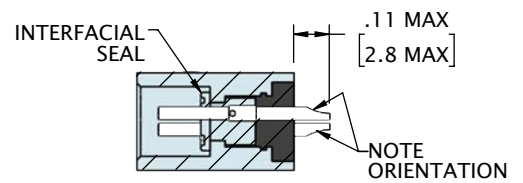
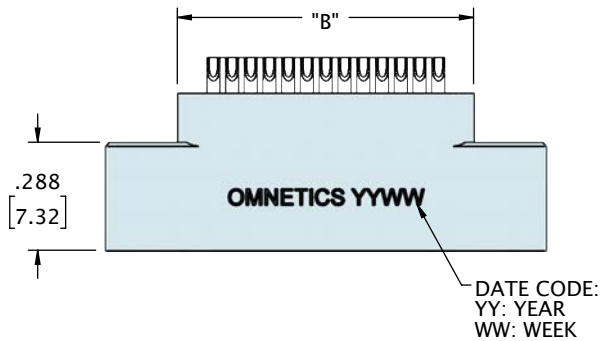

CONTACTS	ROWS	"A"	"B"
9	2	.775 [19.69]	.390 [9.91]
15	2	.925 [23.50]	.540 [13.72]
21	2	1.075 [27.31]	.690 [17.53]
25	2	1.175 [29.85]	.790 [20.07]
31	2	1.325 [33.66]	.940 [23.88]
37	2	1.475 [37.47]	1.090 [27.69]
51	2	1.825 [46.36]	1.440 [36.58]

DIMENSIONS IN [ ] ARE IN MILLIMETERS AND ARE FOR REFERENCE ONLY

## ORDERING GUIDE



<b>1 Series</b>	<b>LMDP</b> Latching Metal Micro-D Pin LMDP - Latch Side (STD)	<b>LMDS</b> Latching Metal Micro-D Socket LMDS - Latch Receptacle side (STD)
<b>2 Number of Contacts</b>	<b>O09</b> <b>O15</b> <b>O21</b> <b>O25</b> <b>O31</b> <b>O37</b> <b>O51*</b>	
<b>3 Termination Type</b>	<b>SS</b> Soldercup	
<b>4 Shell Material &amp; Finish</b>	<b>N</b> Aluminum Shell, Electroless Nickel Plated <b>B</b> Aluminium Shell, Black Anodized	<b>CD</b> Aluminium Shell, Cadmium Plated <b>P</b> Stainless Steel Shell, Passivated
<b>5 Common Options</b>	<b>PA</b> Panel Mount Rear, O-Ring (LMDS only) <b>BSY</b> Custom Backshell (LMDP only) <b>RH</b> RoHS Compliant	<b>PB</b> Panel Mount, Rear (LMDS only) <b>HT</b> High Temp Epoxy
<b>6 Mod Codes</b>	<b>M10</b> Keyed <b>M50</b> Space Grade Micro-D, SPT1	<b>M30</b> Ground Spring <b>M53</b> Space Grade Micro-D, SPT2
<b>7 Special Instructions</b>	<b>YYY</b> Describe anything that is not covered in standard options	

# LATCHING MICRO-D HORIZONTAL SURFACE MOUNT (TYPE HO)

Omnetics **Latching Micro-D Horizontal Surface Mount** Connectors feature our easy-to-use quick-latch mechanism. No tools are required to achieve a supremely secure connection that can endure the rigors of military, aeronautics, and space applications. These high-reliability connectors meet or exceed the shock and vibration requirements of MIL-DTL-83513. They are available in pin counts from 9 to 51 and can be configured to support the unique needs of every design, with discrete wires, overmolded cable, panel mount housings, or PCB-mounted versions. .



## Electro-Mechanical Specifications

TYPE	PERFORMANCE
Durability	> 2000 Mating Cycles min
Temperature	-55°C to +125°C (200 °C w/HTE)
Current rating	3 Amps per contact per MIL-DTL-83513
Voltage Rating (DWV)	600 VAC RMS Sea Level
Insulation Resistance	5,000 Megohms @ 500 VDC
Shock	50 g's with no discontinuities > 1 microsecond
Vibration	20 g's with no discontinuities > 1 microsecond
Thermal Vacuum Outgassing	1.0% max TML, 0.1% max CVCM - NASA SP-R-0022
Contact Resistance	26 milliohms (65 mV) max @ 2.5 Amps per MIL-DTL-83513
Mating/Unmating Force	3 oz. (.85g) typical per contact

## Material Specifications

TYPE	PERFORMANCE
Contact	Copper Alloy Per MIL-DTL-83513
Contact Finish	Gold per ASTM B488, Type II, Class 1.27, Code C Over Nickel Underplate
Insulator	Thermoplastic per MIL-DTL-83513
Interfacial Seal	Silicone Elastomer per A-A-59588
Hardware	Stainless Steel, 300 Series, Passivated per SAE AMS-2700

## Shell Options

MATERIAL	FINISH
Aluminum 6061	Electroless Nickel per SAE-AMS-2404
Stainless Steel, 300 Series	Passivated per SAE-AMS-2700

# LATCHING MICRO-D HORIZONTAL SURFACE MOUNT (TYPE HO)



See page 158 for recommended board layout

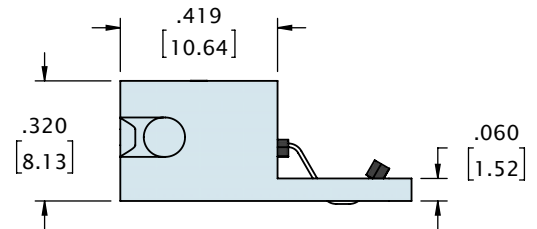
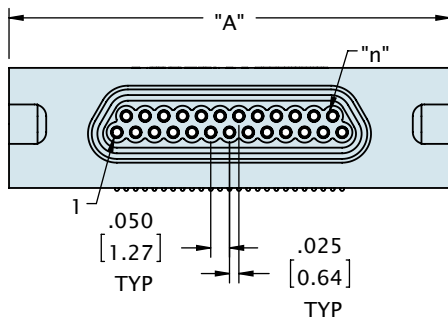
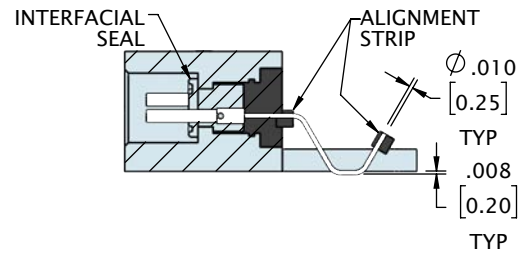
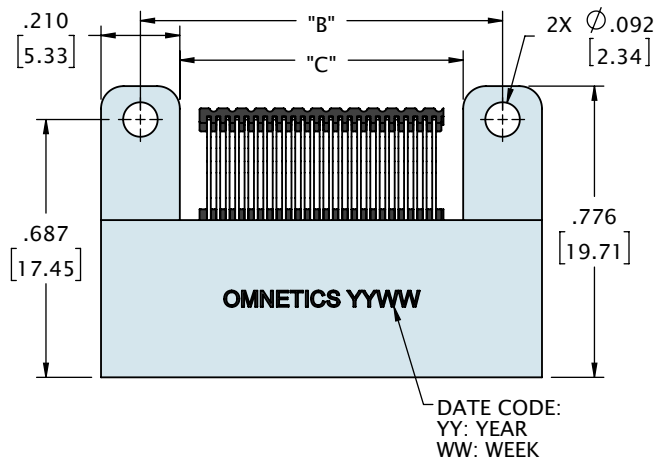

CONTACTS	ROWS	"A"	"B"	"C"
9	2	.775 [19.69]	.565 [14.35]	.355 [9.02]
15	2	.925 [23.50]	.715 [18.16]	.505 [12.83]
21	2	1.075 [27.31]	.865 [21.97]	.655 [16.64]
25	2	1.175 [29.85]	.965 [24.51]	.755 [19.18]
31	2	1.325 [33.66]	1.115 [28.32]	.905 [22.99]
37	2	1.475 [37.47]	1.265 [32.13]	1.055 [26.80]
51	2	1.825 [46.36]	1.615 [41.02]	1.405 [35.69]

DIMENSIONS IN [ ] ARE IN MILLIMETERS AND ARE FOR REFERENCE ONLY

# LATCHING MICRO-D HORIZONTAL SURFACE MOUNT (TYPE HO)

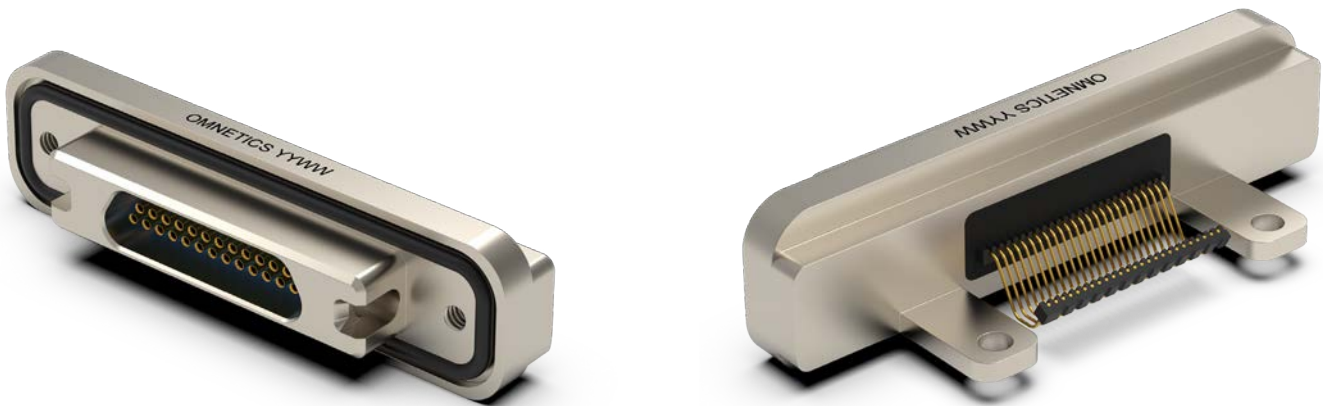

See page 158 for recommended board layout

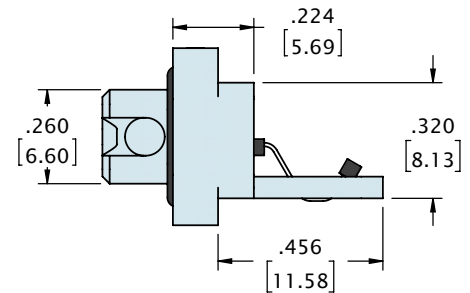
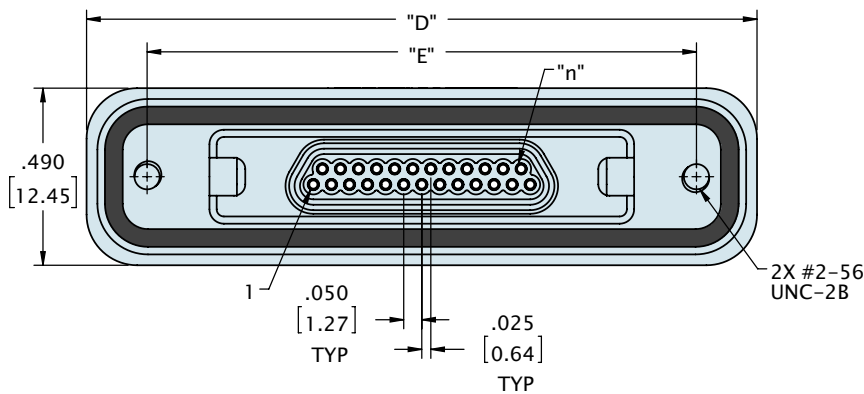
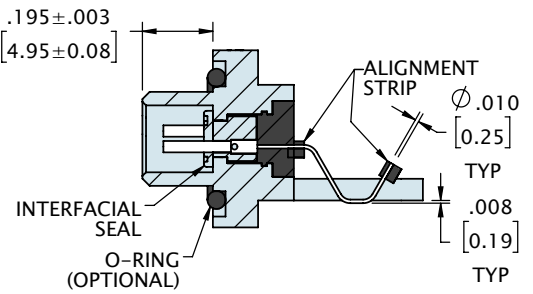
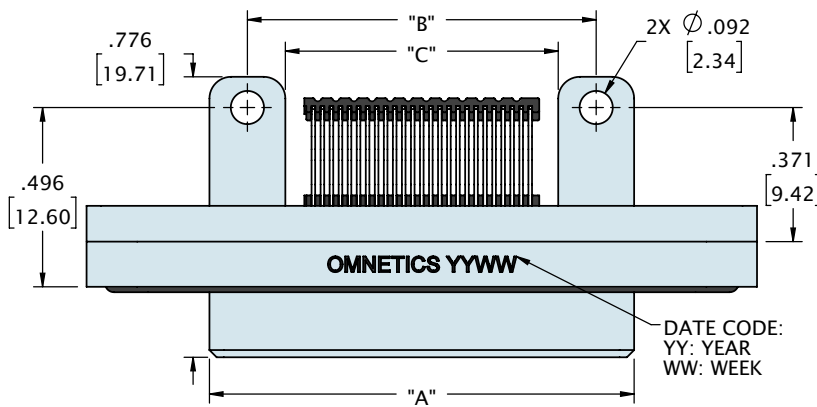

CONTACTS	ROWS	"A"	"B"	"C"	"D"	"E"
9	2	.775 [19.69]	.565 [14.35]	.355 [9.02]	1.455 [36.96]	1.120 [28.45]
15	2	.925 [23.50]	.715 [18.16]	.505 [12.83]	1.605 [40.77]	1.270 [32.26]
21	2	1.075 [27.31]	.865 [21.97]	.655 [16.64]	1.755 [44.58]	1.420 [36.07]
25	2	1.175 [29.85]	.965 [24.51]	.755 [19.18]	1.855 [47.12]	1.520 [38.61]
31	2	1.325 [33.66]	1.115 [28.32]	.905 [22.99]	2.005 [50.93]	1.670 [42.42]
37	2	1.475 [37.47]	1.265 [32.13]	1.055 [26.80]	2.155 [54.74]	1.820 [46.23]
51	2	1.825 [46.36]	1.615 [41.02]	1.405 [35.69]	2.505 [63.63]	2.170 [55.12]

DIMENSIONS IN [ ] ARE IN MILLIMETERS AND ARE FOR REFERENCE ONLY



## ORDERING GUIDE

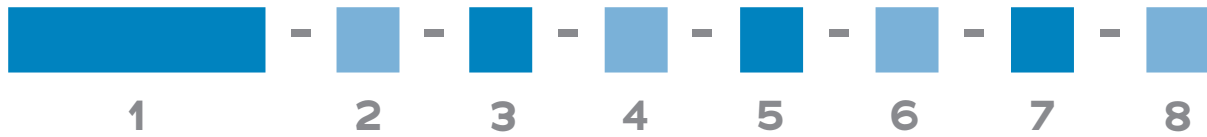

<b>1 Series</b>	<b>LMDS</b> Latching Metal Micro-D Socket	
<b>2 Number of Contacts</b>	<b>O09</b> <b>O15</b> <b>O21</b> <b>O25</b> <b>O31</b> <b>O37</b> <b>O51*</b>	
	* Use <b>512</b> for Two Rows <b>O51</b>	
<b>3 Termination Type</b>	<b>HO</b> Horizontal Surface Mount	
<b>4 Shell Material &amp; Finish</b>	<b>N</b> Aluminum Shell, Electroless Nickel Plated <b>B</b> Aluminium Shell, Black Anodized	<b>CD</b> Aluminium Shell, Cadmium Plated <b>P</b> Stainless Steel Shell, Passivated
<b>6 Common Options</b>	<b>PA</b> Panel Mount Rear, O-Ring <b>HT</b> High Temp Epoxy	<b>PB</b> Panel Mount, Rear <b>RH</b> RoHS Compliant
<b>7 Mod Codes</b>	<b>M10</b> Keyed <b>M50</b> Space Grade Micro-D, SPT1	<b>M30</b> Ground Spring <b>M53</b> Space Grade Micro-D, SPT2
<b>8 Special Instructions</b>	<b>YYY</b> Describe anything that is not covered in standard options	

# LATCHING MICRO-D VERTICAL SURFACE MOUNT (TYPE VV)

Omnetics **Latching Micro-D Vertical Surface Mount** Connectors feature our easy-to-use quick-latch mechanism. No threaded hardware is involved and no tools are required to achieve a supremely secure connection that can endure the rigors of military, aeronautics, and space applications. These high-reliability connectors meet or exceed the shock and vibration requirements of MIL-DTL-83513. They feature Omnetics' one-piece flex pin design to provide additional protection against shock and vibration. This is an ideal connector for applications that are in constant or unpredictable motion. We offer a wide range of configurations, including multiple plating options, and a panel mount version with discrete wire, cable, or solder cup.

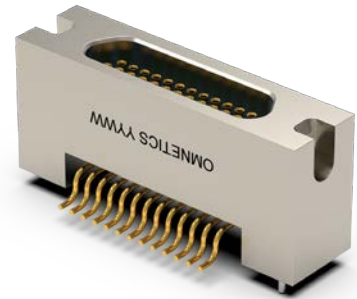

## Electro-Mechanical Specifications

TYPE	PERFORMANCE
Durability	> 2000 Mating Cycles min
Temperature	-55°C to +125°C (200 °C w/HTE)
Current rating	3 Amps per contact per MIL-DTL-83513
Voltage Rating (DWV)	600 VAC RMS Sea Level
Insulation Resistance	5,000 Megohms @ 500 VDC
Shock	50 g's with no discontinuities > 1 microsecond
Vibration	20 g's with no discontinuities > 1 microsecond
Thermal Vacuum Outgassing	1.0% max TML, 0.1% max CVCM - NASA SP-R-0022
Contact Resistance	26 milliohms (65 mV) max @ 2.5 Amps per MIL-DTL-83513
Mating/Unmating Force	3 oz. (.85g) typical per contact

## Material Specifications

TYPE	PERFORMANCE
Contact	Copper Alloy Per MIL-DTL-83513
Contact Finish	Gold per ASTM B488, Type II, Class 1.27, Code C Over Nickel Underplate
Insulator	Thermoplastic per MIL-DTL-83513
Interfacial Seal	Silicone Elastomer per A-A-59588
Hardware	Stainless Steel, 300 Series, Passivated per SAE AMS-2700

## Shell Options

MATERIAL	FINISH
Aluminum 6061	Electroless Nickel per SAE-AMS-2404
Stainless Steel, 300 Series	Passivated per SAE-AMS-2700

# LATCHING MICRO-D VERTICAL SURFACE MOUNT (TYPE VV)



See page 158 for recommended board layout

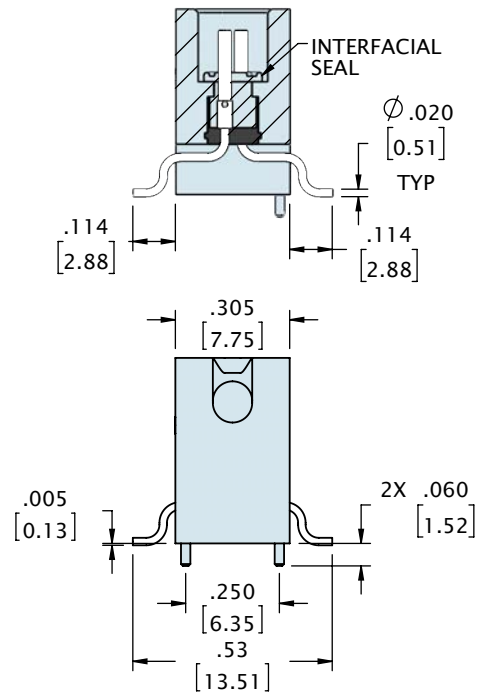
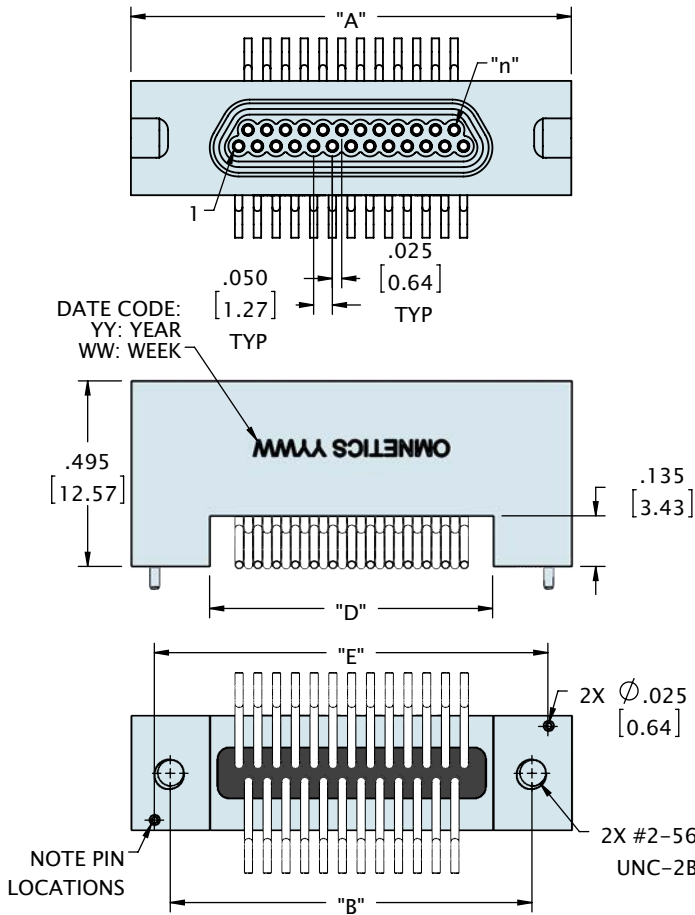

CONTACTS	ROWS	"A"	"B"	"D"	"E"
9	2	.775 [19.69]	.565 [14.35]	.355 [9.02]	.650 [16.51]
15	2	.925 [23.50]	.715 [18.16]	.505 [12.83]	.800 [20.32]
21	2	1.075 [27.31]	.865 [21.97]	.655 [16.64]	.950 [24.13]
25	2	1.175 [29.85]	.965 [24.51]	.755 [19.18]	1.050 [26.67]
31	2	1.325 [33.66]	1.115 [28.32]	.905 [22.99]	1.200 [30.48]
37	2	1.475 [37.47]	1.265 [32.13]	1.055 [26.80]	1.350 [34.29]
51	2	1.825 [46.36]	1.615 [41.02]	1.405 [35.69]	1.700 [43.18]

DIMENSIONS IN [ ] ARE IN MILLIMETERS AND ARE FOR REFERENCE ONLY

# LATCHING MICRO-D VERTICAL SURFACE MOUNT (TYPE VV)



See page 158 for recommended board layout

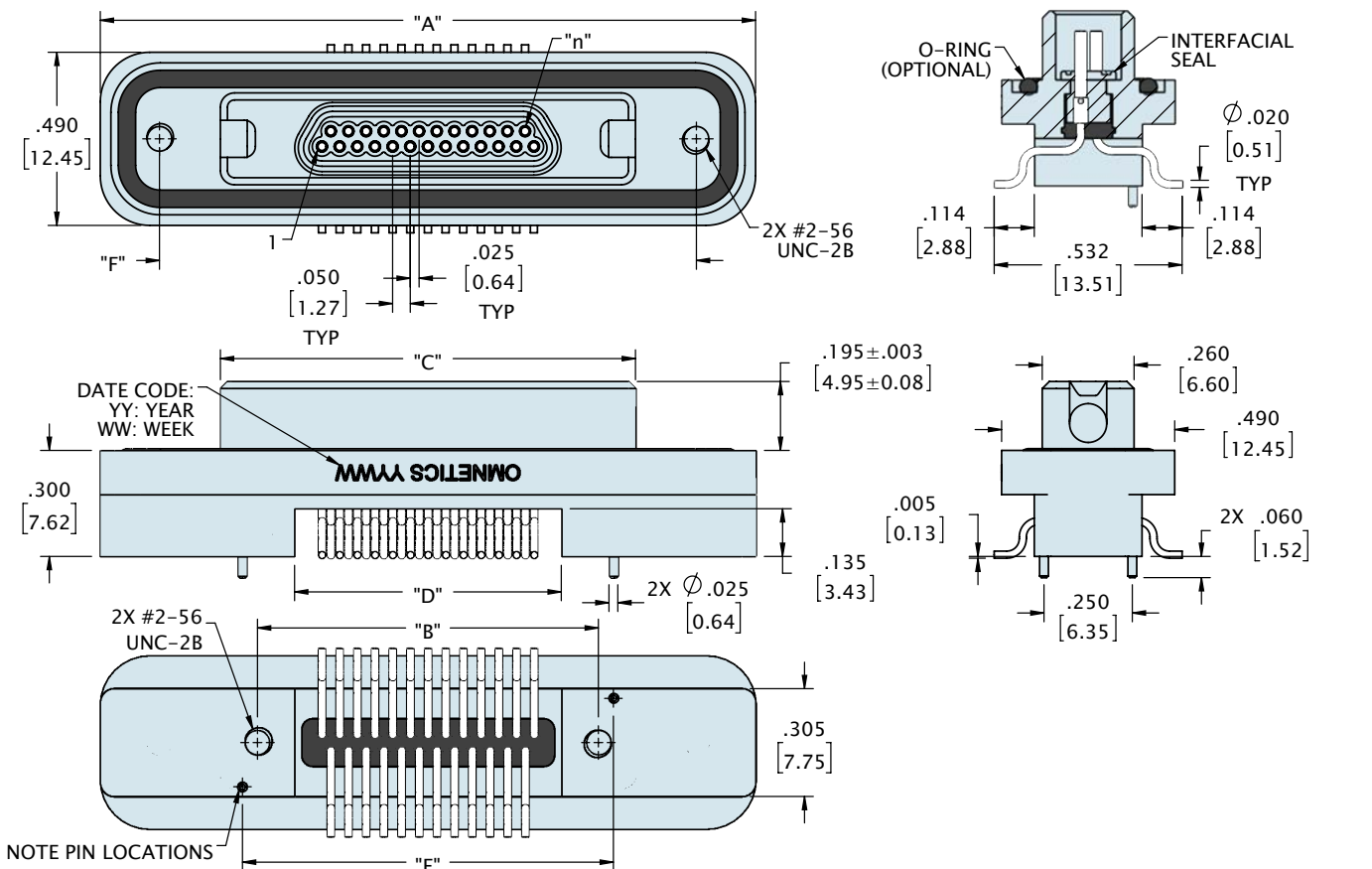

CONTACTS	ROWS	"A"	"B"	"C"	"D"	"E"	"F"
9	2	1.455 [36.96]	.565 [14.35]	.775 [19.69]	.355 [9.02]	.650 [16.51]	1.120 [28.45]
15	2	1.605 [40.77]	.715 [18.16]	.925 [23.50]	.505 [12.83]	.800 [20.32]	1.270 [32.26]
21	2	1.755 [44.58]	.865 [21.97]	1.075 [27.31]	.655 [16.64]	.950 [24.13]	1.420 [36.07]
25	2	1.855 [47.12]	.965 [24.51]	1.175 [29.85]	.755 [19.18]	1.050 [26.67]	1.520 [38.61]
31	2	2.005 [50.93]	1.115 [28.32]	1.325 [33.66]	.905 [22.99]	1.200 [30.48]	1.670 [42.42]
37	2	2.155 [54.74]	1.265 [32.13]	1.475 [37.47]	1.055 [26.80]	1.350 [34.29]	1.820 [46.23]
51	2	2.505 [63.63]	1.615 [41.02]	1.825 [46.36]	1.405 [35.69]	1.700 [43.18]	2.170 [55.12]

DIMENSIONS IN [ ] ARE IN MILLIMETERS AND ARE FOR REFERENCE ONLY

## ORDERING GUIDE

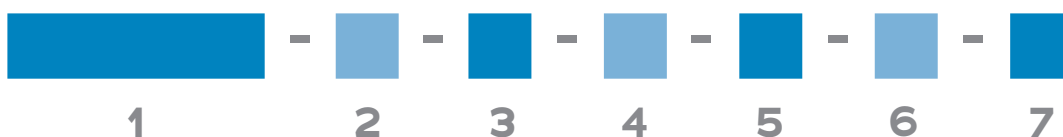

<b>1 Series</b>	LMDS Latching Metal Micro-D Socket						
<b>2 Number of Contacts</b>	009	015	021	025	031	037	051*
	* Use 512 for Two Rows 051						
<b>3 Termination Type</b>	VV Vertical Surface Mount						
<b>4 Shell Material &amp; Finish</b>	N Aluminum Shell, Electroless Nickel Plated			CD Aluminium Shell, Cadmium Plated			
	B Aluminium Shell, Black Anodized			P Stainless Steel Shell, Passivated			
<b>5 Common Options</b>	PA Panel Mount Rear, O-Ring			PB Panel Mount, Rear			
	HT High Temp Epoxy			RH RoHS Compliant			
<b>6 Mod Codes</b>	M10 Keyed			M30 Ground Spring			
	M50 Space Grade Micro-D, SPT1			M53 Space Grade Micro-D, SPT2			
<b>7 Special Instructions</b>	YYY Describe anything that is not covered in standard options						

# LATCHING MICRO-D CARD EDGE SURFACE MOUNT (TYPE CO)

Omnetics **Latching Micro-D Card Edge Surface Mount** Connectors save space on the board while providing exceptional security through our easy-to-use quick-latch mechanism. No threaded hardware is involved and no tools are required to achieve a supremely secure connection that can endure the rigors of military, aeronautics, and space applications. These high-reliability connectors meet or exceed the shock and vibration requirements of MIL-DTL-83513. They feature our one-piece flex pin design to provide additional protection against shock and vibration. We offer this connector in a wide range of configurations to suit your specifications, including shell sizes from 9 to 51 contacts, multiple plating options, and a panel mount version with discrete wire, cable, or solder cup.



## Electro-Mechanical Specifications

TYPE	PERFORMANCE
Durability	> 2000 Mating Cycles min
Temperature	-55°C to +125°C (200 °C w/HTE)
Current rating	3 Amps per contact per MIL-DTL-83513
Voltage Rating (DWV)	600 VAC RMS Sea Level
Insulation Resistance	5,000 Megohms @ 500 VDC
Shock	50 g's with no discontinuities > 1 microsecond
Vibration	20 g's with no discontinuities > 1 microsecond
Thermal Vacuum Outgassing	1.0% max TML, 0.1% max CVCM - NASA SP-R-0022
Contact Resistance	26 milliohms (65 mV) max @ 2.5 Amps per MIL-DTL-83513
Mating/Unmating Force	3 oz. (.85g) typical per contact

## Material Specifications

TYPE	PERFORMANCE
Contact	Copper Alloy Per MIL-DTL-83513
Contact Finish	Gold per ASTM B488, Type II, Class 1.27, Code C Over Nickel Underplate
Insulator	Thermoplastic per MIL-DTL-83513
Interfacial Seal	Silicone Elastomer per A-A-59588
Hardware	Stainless Steel, 300 Series, Passivated per SAE AMS-2700

## Shell Options

MATERIAL	FINISH
Aluminum 6061	Electroless Nickel per SAE-AMS-2404
Stainless Steel, 300 Series	Passivated per SAE-AMS-2700

# LATCHING MICRO-D CARD EDGE SURFACE MOUNT (TYPE CO)

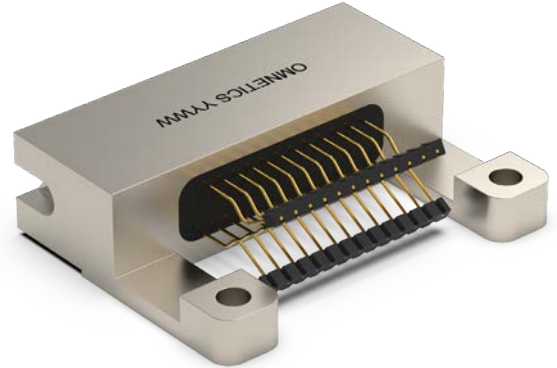

See page 159 for recommended board layout

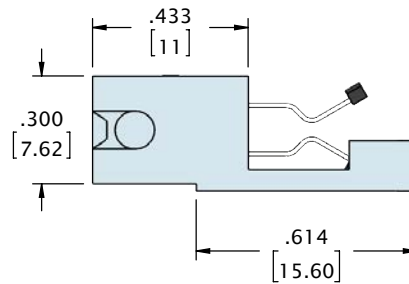
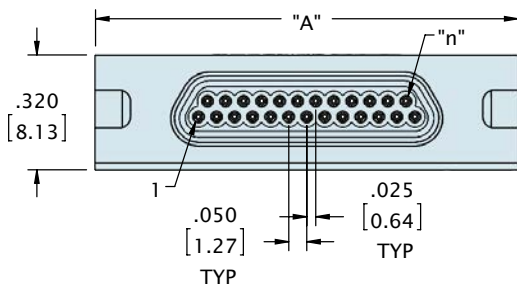
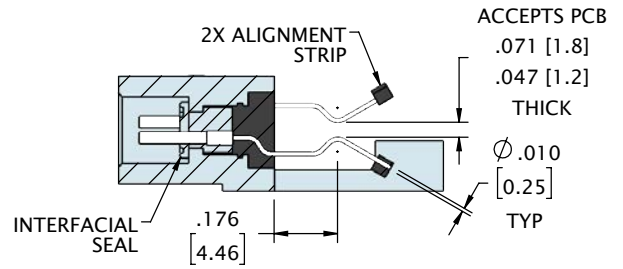
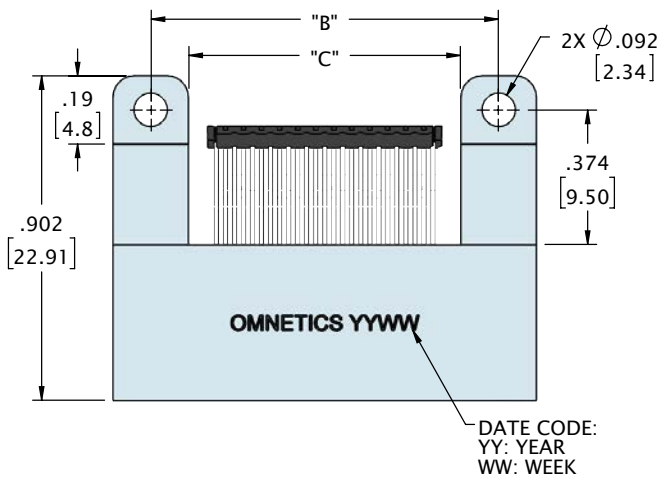

CONTACTS	ROWS	"A"	"B"	"C"
9	2	.775 [19.69]	.565 [14.35]	.355 [9.02]
15	2	.925 [23.50]	.715 [18.16]	.505 [12.83]
21	2	1.075 [27.31]	.865 [21.97]	.655 [16.64]
25	2	1.175 [29.85]	.965 [24.51]	.755 [19.18]
31	2	1.325 [33.66]	1.115 [28.32]	.905 [22.99]
37	2	1.475 [37.47]	1.265 [32.13]	1.055 [26.80]
51	2	1.825 [46.36]	1.615 [41.02]	1.405 [35.69]

DIMENSIONS IN [ ] ARE IN MILLIMETERS AND ARE FOR REFERENCE ONLY

# LATCHING MICRO-D CARD EDGE SURFACE MOUNT (TYPE CO)

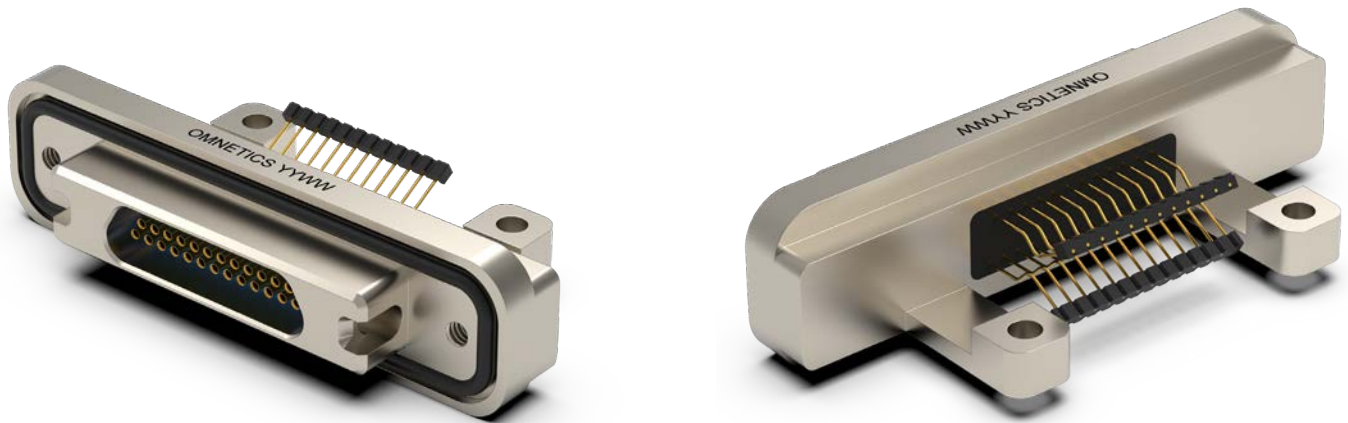

See page 159 for recommended board layout

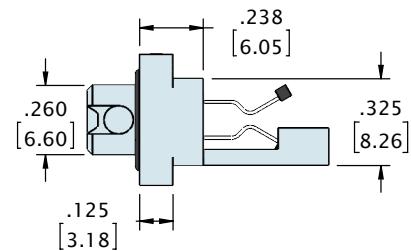
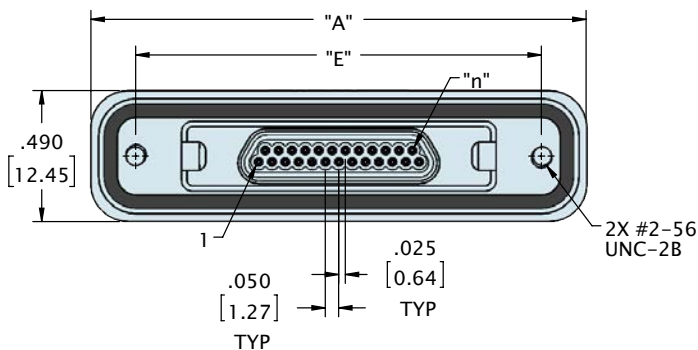
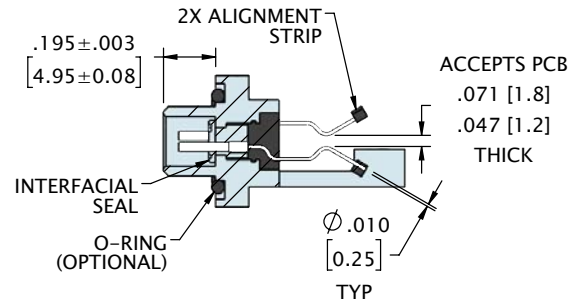
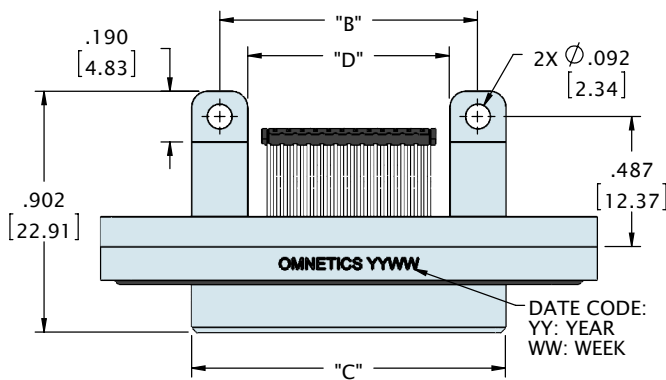

CONTACTS	ROWS	"A"	"B"	"C"	"D"	"E"
9	2	1.455 [36.96]	.565 [14.35]	.775 [19.69]	.355 [9.02]	1.230 [31.24]
15	2	1.605 [40.77]	.715 [18.16]	.925 [23.50]	.505 [12.83]	1.380 [35.05]
21	2	1.755 [44.58]	.865 [21.97]	1.075 [27.31]	.655 [16.64]	1.530 [38.86]
25	2	1.855 [47.12]	.965 [24.51]	1.175 [29.85]	.755 [19.18]	1.630 [41.40]
31	2	2.005 [50.93]	1.115 [28.32]	1.325 [33.66]	.905 [22.99]	1.780 [45.21]
37	2	2.155 [54.74]	1.265 [32.13]	1.475 [37.47]	1.055 [26.80]	1.930 [49.02]
51	2	2.505 [63.63]	1.615 [41.02]	1.825 [46.36]	1.405 [35.69]	2.280 [57.91]

DIMENSIONS IN [ ] ARE IN MILLIMETERS AND ARE FOR REFERENCE ONLY



## ORDERING GUIDE



<b>1 Series</b>	<b>LMDS</b> Latching Metal Micro-D Socket							
<b>2 Number of Contacts</b>	<table style="width: 100%; border: none;"> <tr> <td style="text-align: center;">009</td> <td style="text-align: center;">015</td> <td style="text-align: center;">021</td> <td style="text-align: center;">025</td> <td style="text-align: center;">031</td> <td style="text-align: center;">037</td> <td style="text-align: center;">051*</td> </tr> </table> <p><small>* Use 512 for Two Rows 051</small></p>	009	015	021	025	031	037	051*
009	015	021	025	031	037	051*		
<b>3 Termination Type</b>	<b>CO</b> Card Edge Surface Mount							
<b>4 Shell Material &amp; Finish</b>	<table style="width: 100%; border: none;"> <tr> <td style="width: 50%;"><b>N</b> Aluminum Shell, Electroless Nickel Plated</td> <td style="width: 50%;"><b>CD</b> Aluminium Shell, Cadmium Plated</td> </tr> <tr> <td><b>B</b> Aluminium Shell, Black Anodized</td> <td><b>P</b> Stainless Steel Shell, Passivated</td> </tr> </table>	<b>N</b> Aluminum Shell, Electroless Nickel Plated	<b>CD</b> Aluminium Shell, Cadmium Plated	<b>B</b> Aluminium Shell, Black Anodized	<b>P</b> Stainless Steel Shell, Passivated			
<b>N</b> Aluminum Shell, Electroless Nickel Plated	<b>CD</b> Aluminium Shell, Cadmium Plated							
<b>B</b> Aluminium Shell, Black Anodized	<b>P</b> Stainless Steel Shell, Passivated							
<b>5 Common Options</b>	<table style="width: 100%; border: none;"> <tr> <td style="width: 50%;"><b>PA</b> Panel Mount Rear, O-Ring</td> <td style="width: 50%;"><b>PB</b> Panel Mount, Rear</td> </tr> <tr> <td><b>HT</b> High Temp Epoxy</td> <td><b>RH</b> RoHS Compliant</td> </tr> </table>	<b>PA</b> Panel Mount Rear, O-Ring	<b>PB</b> Panel Mount, Rear	<b>HT</b> High Temp Epoxy	<b>RH</b> RoHS Compliant			
<b>PA</b> Panel Mount Rear, O-Ring	<b>PB</b> Panel Mount, Rear							
<b>HT</b> High Temp Epoxy	<b>RH</b> RoHS Compliant							
<b>6 Mod Codes</b>	<table style="width: 100%; border: none;"> <tr> <td style="width: 50%;"><b>M10</b> Keyed</td> <td style="width: 50%;"><b>M30</b> Ground Spring</td> </tr> <tr> <td><b>M50</b> Space Grade Micro-D, SPT1</td> <td><b>M53</b> Space Grade Micro-D, SPT2</td> </tr> </table>	<b>M10</b> Keyed	<b>M30</b> Ground Spring	<b>M50</b> Space Grade Micro-D, SPT1	<b>M53</b> Space Grade Micro-D, SPT2			
<b>M10</b> Keyed	<b>M30</b> Ground Spring							
<b>M50</b> Space Grade Micro-D, SPT1	<b>M53</b> Space Grade Micro-D, SPT2							
<b>7 Special Instructions</b>	<b>YYY</b> Describe anything that is not covered in standard options							

# LATCHING MICRO-D FLEX TAIL (TYPE FF)

Omnetics **Latching Micro-D Flex Tail** Connectors provide today's rugged technologies with exceptional security through our quick-latch mechanism. This easy-to-use connector requires no threaded or tools to achieve a supremely secure connection that can endure the rigors of medical, military, aeronautics, and space applications. These high-reliability connectors meet or exceed the shock and vibration requirements of MIL-DTL-83513. They feature Omnetics' one-piece flex pin design to provide additional protection against shock and vibration. We offer this connector in a wide range of configurations to suit your specifications, including shell sizes from 9 to 51 contacts, multiple plating options, and a panel mount version with discrete wire, cable, or solder cup.



## Electro-Mechanical Specifications

TYPE	PERFORMANCE
Durability	> 2000 Mating Cycles min
Temperature	-55°C to +125°C (200 °C w/HTE)
Current rating	3 Amps per contact per MIL-DTL-83513
Voltage Rating (DWV)	600 VAC RMS Sea Level
Insulation Resistance	5,000 Megohms @ 500 VDC
Shock	50 g's with no discontinuities > 1 microsecond
Vibration	20 g's with no discontinuities > 1 microsecond
Thermal Vacuum Outgassing	1.0% max TML, 0.1% max CVCM - NASA SP-R-0022
Contact Resistance	26 milliohms (65 mV) max @ 2.5 Amps per MIL-DTL-83513
Mating/Unmating Force	3 oz. (.85g) typical per contact

## Material Specifications

TYPE	PERFORMANCE
Contact	Copper Alloy Per MIL-DTL-83513
Contact Finish	Gold per ASTM B488, Type II, Class 1.27, Code C Over Nickel Underplate
Insulator	Thermoplastic per MIL-DTL-83513
Interfacial Seal	Silicone Elastomer per A-A-59588
Hardware	Stainless Steel, 300 Series, Passivated per SAE AMS-2700

## Shell Options

MATERIAL	FINISH
Aluminum 6061	Electroless Nickel per SAE-AMS-2404
Stainless Steel, 300 Series	Passivated per SAE-AMS-2700

# LATCHING MICRO-D FLEX TAIL (TYPE FF)



See page 159 for recommended board layout

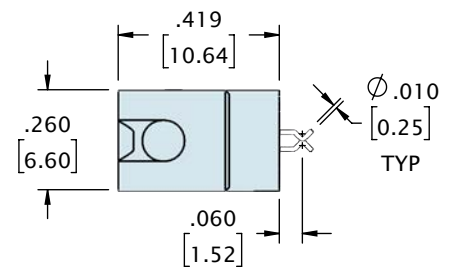
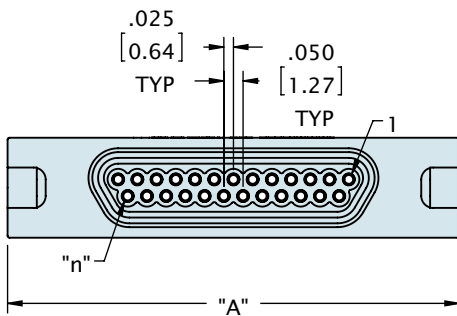
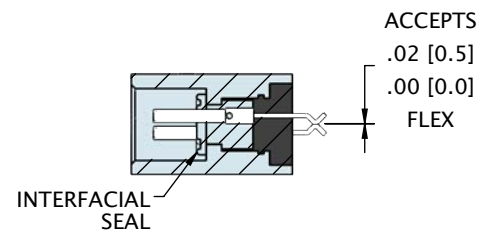
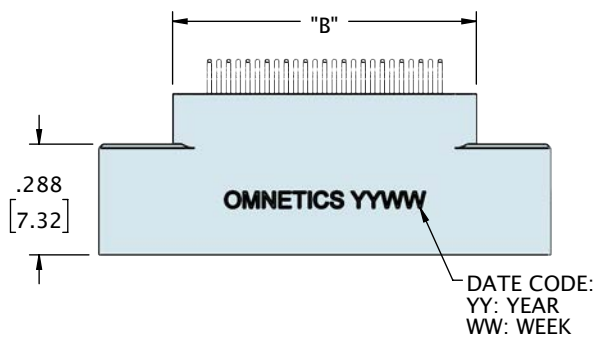

CONTACTS	ROWS	"A"	"B"
9	2	.775 [19.69]	.390 [9.91]
15	2	.925 [23.50]	.540 [13.72]
21	2	1.075 [27.31]	.690 [17.53]
25	2	1.175 [29.85]	.790 [20.07]
31	2	1.325 [33.66]	.940 [23.88]
37	2	1.475 [37.47]	1.090 [27.69]
51	2	1.825 [46.36]	1.440 [36.58]

DIMENSIONS IN [ ] ARE IN MILLIMETERS AND ARE FOR REFERENCE ONLY

# LATCHING MICRO-D FLEX TAIL (TYPE FF)



See page 159 for recommended board layout

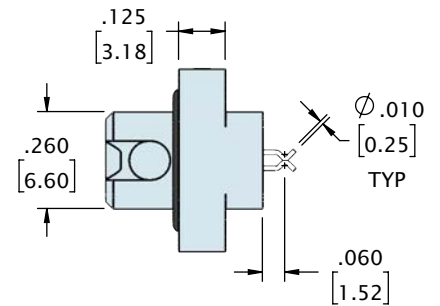
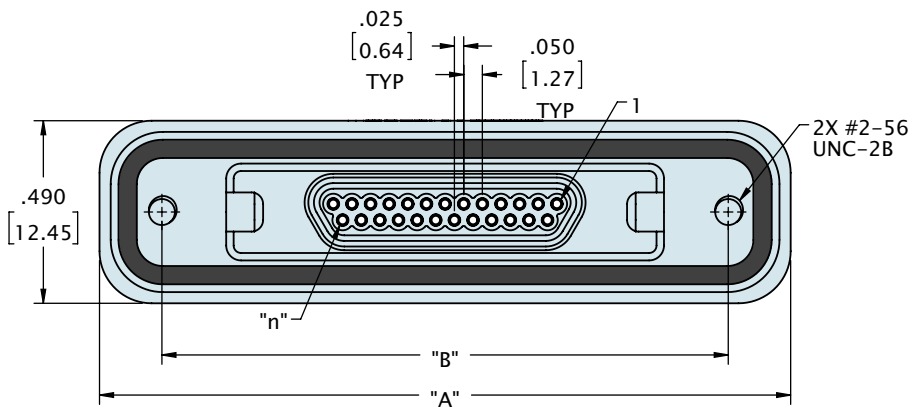
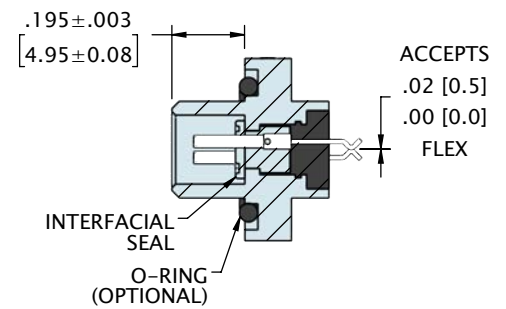
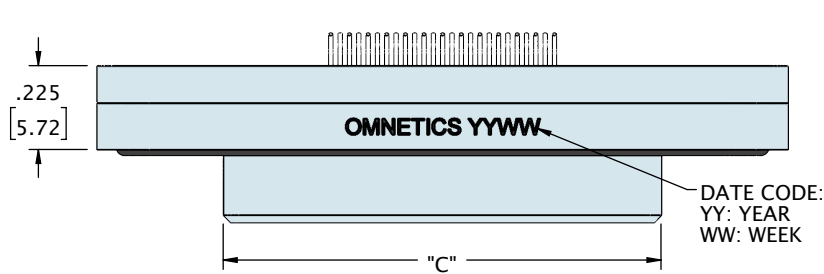

CONTACTS	ROWS	"A"	"B"	"C"
9	2	1.455 [36.96]	1.120 [28.45]	.775 [19.69]
15	2	1.605 [40.77]	1.270 [32.26]	.925 [23.50]
21	2	1.755 [44.58]	1.420 [36.07]	1.075 [27.31]
25	2	1.855 [47.12]	1.520 [38.61]	1.175 [29.85]
31	2	2.005 [50.93]	1.670 [42.42]	1.325 [33.66]
37	2	2.155 [54.74]	1.820 [46.23]	1.475 [37.47]
51	2	2.505 [63.63]	2.170 [55.12]	1.825 [46.36]

DIMENSIONS IN [ ] ARE IN MILLIMETERS AND ARE FOR REFERENCE ONLY

## ORDERING GUIDE

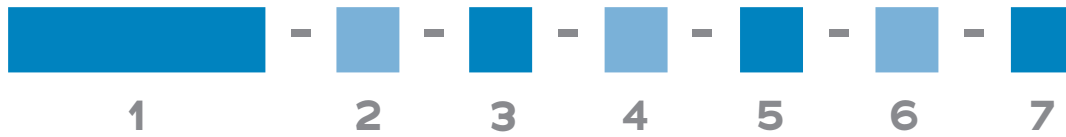

<b>1 Series</b>	LMDS Latching Metal Micro-D Socket	
<b>2 Number of Contacts</b>	O09      O15      O21      O25      O31      O37      O51*	
* Use 512 for Two Rows O51		
<b>3 Termination Type</b>	FF Flex Tail	
<b>4 Shell Material &amp; Finish</b>	N Aluminum Shell, Electroless Nickel Plated B Aluminium Shell, Black Anodized	CD Aluminium Shell, Cadmium Plated P Stainless Steel Shell, Passivated
<b>5 Common Options</b>	PA Panel Mount Rear, O-Ring HT High Temp Epoxy	PB Panel Mount, Rear RH RoHS Compliant
<b>6 Mod Codes</b>	M10 Keyed M50 Space Grade Micro-D, SPT1	M30 Ground Spring M53 Space Grade Micro-D, SPT2
<b>7 Special Instructions</b>	YYY Describe anything that is not covered in standard options	

# LATCHING MICRO-D STRAIGHT THRU-HOLE (TYPE DD)

Omnetics **Latching Micro-D Straight Thru-Hole** Connectors provide today's rugged technologies with exceptional security through our quick-latch mechanism. Simple connectivity in the field can be achieved without threading or tools. Our goal is to serve designers of military, aeronautics, space, and other high-reliability technologies with components that enable their most ambitious ideas. These high-reliability connectors meet or exceed the shock and vibration requirements of MIL-DTL-83513. They feature Omnetics' one-piece flex pin design to provide additional protection. We offer this connector in a wide range of configurations to suit your specifications, including shell sizes from 9 to 51 contacts, multiple plating options, and a panel mount version.



## Electro-Mechanical Specifications

TYPE	PERFORMANCE
Durability	> 2000 Mating Cycles min
Temperature	-55°C to +125°C (200 °C w/HTE)
Current rating	3 Amps per contact per MIL-DTL-83513
Voltage Rating (DWV)	600 VAC RMS Sea Level
Insulation Resistance	5,000 Megohms @ 500 VDC
Shock	50 g's with no discontinuities > 1 microsecond
Vibration	20 g's with no discontinuities > 1 microsecond
Thermal Vacuum Outgassing	1.0% max TML, 0.1% max CVCM - NASA SP-R-0022
Contact Resistance	26 milliohms (65 mV) max @ 2.5 Amps per MIL-DTL-83513
Mating/Unmating Force	3 oz. (.85g) typical per contact

## Material Specifications

TYPE	PERFORMANCE
Contact	Copper Alloy Per MIL-DTL-83513
Contact Finish	Gold per ASTM B488, Type II, Class 1.27, Code C Over Nickel Underplate
Insulator	Thermoplastic per MIL-DTL-83513
Interfacial Seal	Silicone Elastomer per A-A-59588
Hardware	Stainless Steel, 300 Series, Passivated per SAE AMS-2700

## Shell Options

MATERIAL	FINISH
Aluminum 6061	Electroless Nickel per SAE-AMS-2404
Stainless Steel, 300 Series	Passivated per SAE-AMS-2700

# LATCHING MICRO-D STRAIGHT THRU-HOLE (TYPE DD)



See page 160 for recommended board layout

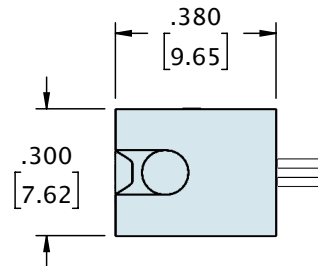
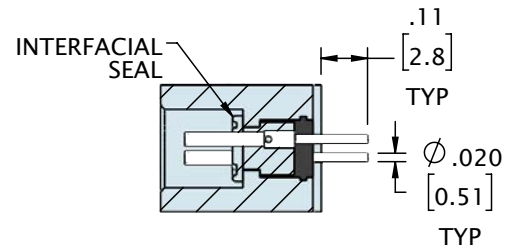
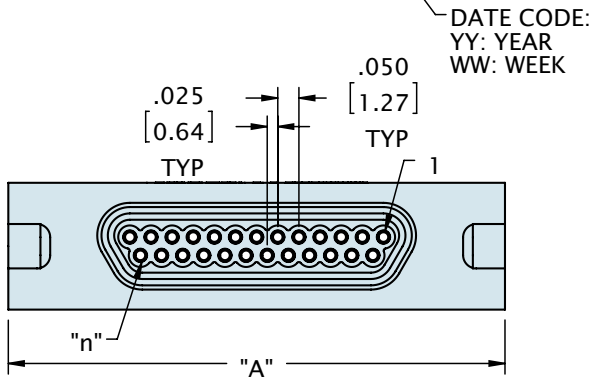
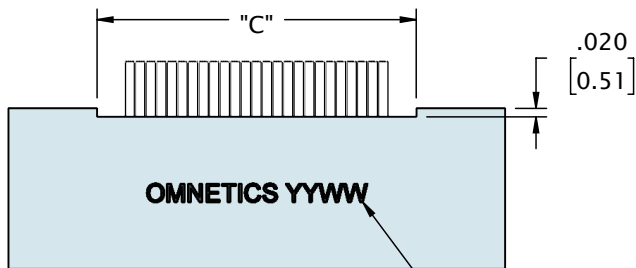
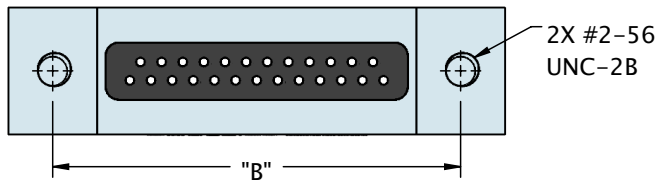

CONTACTS	ROWS	"A"	"B"	"C"
9	2	.775 [19.69]	.565 [14.35]	.355 [9.02]
15	2	.925 [23.50]	.715 [18.16]	.505 [12.83]
21	2	1.075 [27.31]	.865 [21.97]	.655 [16.64]
25	2	1.175 [29.85]	.965 [24.51]	.755 [19.18]
31	2	1.325 [33.66]	1.115 [28.32]	.905 [22.99]
37	2	1.475 [37.47]	1.265 [32.13]	1.055 [26.80]
51	2	1.825 [46.36]	1.615 [41.02]	1.405 [35.69]

DIMENSIONS IN [ ] ARE IN MILLIMETERS AND ARE FOR REFERENCE ONLY

# LATCHING MICRO-D STRAIGHT THRU-HOLE (TYPE DD)

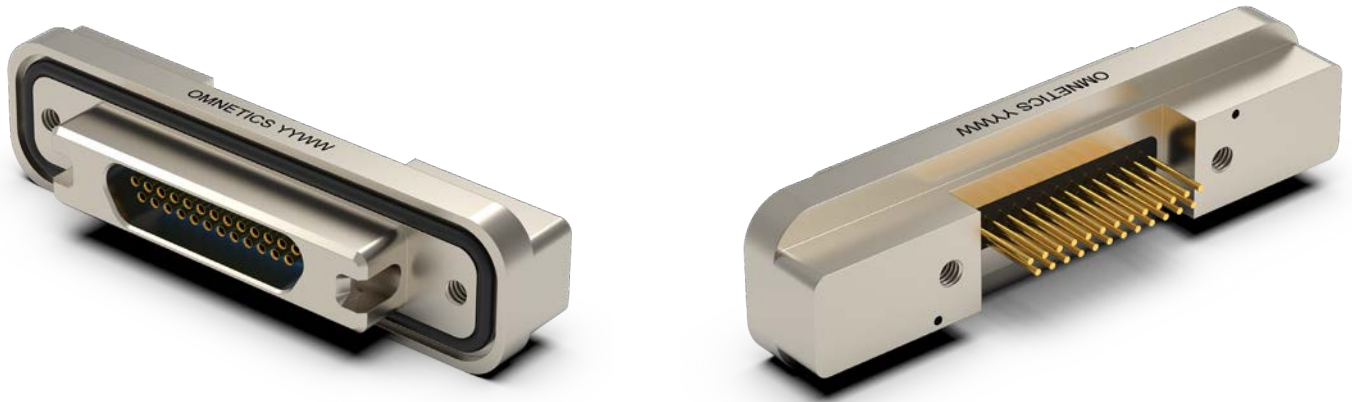

See page 160 for recommended board layout

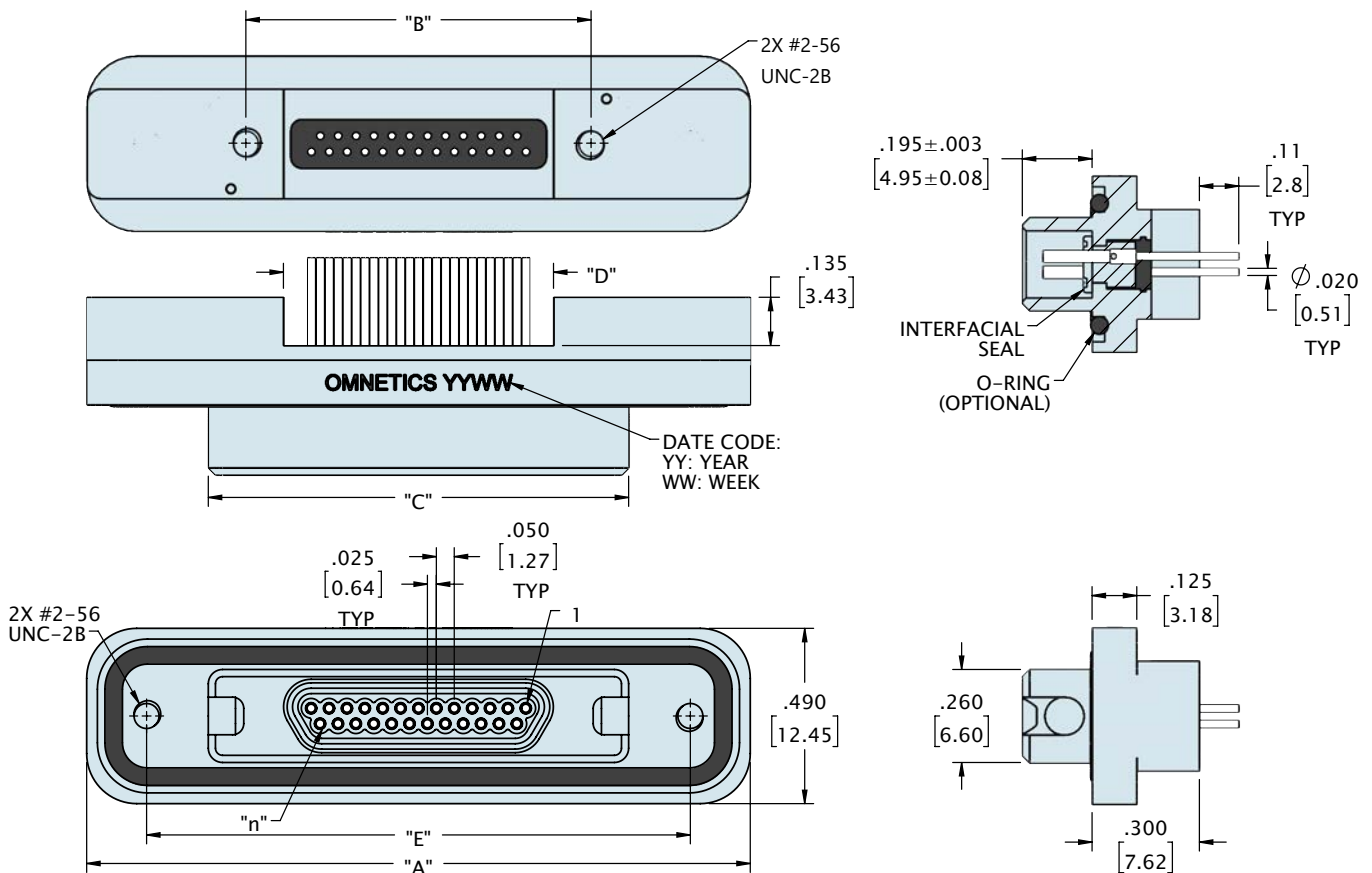

CONTACTS	ROWS	"A"	"B"	"C"	"D"	"E"
9	2	1.455 [36.96]	.565 [14.35]	.775 [19.69]	.355 [9.02]	1.120 [28.45]
15	2	1.605 [40.77]	.715 [18.16]	.925 [23.50]	.505 [12.83]	1.270 [32.26]
21	2	1.755 [44.58]	.865 [21.97]	1.075 [27.31]	.655 [16.64]	1.420 [36.07]
25	2	1.855 [47.12]	.965 [24.51]	1.175 [29.85]	.755 [19.18]	1.520 [38.61]
31	2	2.005 [50.93]	1.115 [28.32]	1.325 [33.66]	.905 [22.99]	1.670 [42.42]
37	2	2.155 [54.74]	1.265 [32.13]	1.475 [37.47]	1.055 [26.80]	1.820 [46.23]
51	2	2.505 [63.63]	1.615 [41.02]	1.825 [46.36]	1.405 [35.69]	2.170 [55.12]

DIMENSIONS IN [ ] ARE IN MILLIMETERS AND ARE FOR REFERENCE ONLY



## ORDERING GUIDE

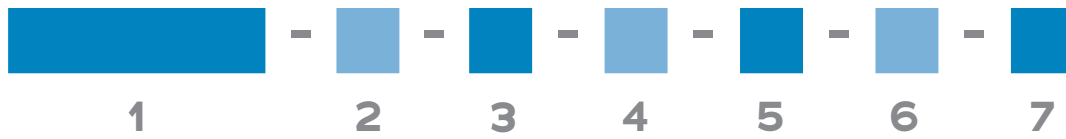

<b>1 Series</b>	LMDS Latching Metal Micro-D Socket						
<b>2 Number of Contacts</b>	O09	O15	O21	O25	O31	O37	O51*
	* Use 512 for Two Rows O51						
<b>3 Termination Type</b>	DD Straight Thru-Hole						
<b>4 Shell Material &amp; Finish</b>	N Aluminum Shell, Electroless Nickel Plated			CD Aluminium Shell, Cadmium Plated			
	B Aluminium Shell, Black Anodized			P Stainless Steel Shell, Passivated			
<b>5 Common Options</b>	PA Panel Mount Rear, O-Ring			PB Panel Mount, Rear			
	HT High Temp Epoxy			RH RoHS Compliant			
<b>6 Mod Codes</b>	M10 Keyed			M30 Ground Spring			
	M50 Space Grade Micro-D, SPT1			M53 Space Grade Micro-D, SPT2			
<b>7 Special Instructions</b>	YYY Describe anything that is not covered in standard options						

# LATCHING MICRO-D RIGHT ANGLE THRU-HOLE (TYPE H2)

Omnetics **Latching Micro-D Right Angle Thru-Hole Connectors** support complex or space-constrained designs. This tiny connector provides the most rugged technologies with exceptional security through our quick-latch mechanism. No threading or tools are needed to achieve a connection. Designers can depend on this connector to perform in the most demanding conditions and in applications where size and weight are concerns. These high-reliability connectors meet or exceed the shock and vibration requirements of MIL-DTL-83513. We offer this connector in a wide range of configurations to suit your specifications, including shell sizes from 9 to 51 contacts, multiple plating options, and a panel mount version with discrete wire, cable, or solder cup.



## Electro-Mechanical Specifications

TYPE	PERFORMANCE
Durability	> 2000 Mating Cycles min
Temperature	-55°C to +125°C (200 °C w/HTE)
Current rating	3 Amps per contact per MIL-DTL-83513
Voltage Rating (DWV)	600 VAC RMS Sea Level
Insulation Resistance	5,000 Megohms @ 500 VDC
Shock	50 g's with no discontinuities > 1 microsecond
Vibration	20 g's with no discontinuities > 1 microsecond
Thermal Vacuum Outgassing	1.0% max TML, 0.1% max CVCM - NASA SP-R-0022
Contact Resistance	26 milliohms (65 mV) max @ 2.5 Amps per MIL-DTL-83513
Mating/Unmating Force	3 oz. (.85g) typical per contact

## Material Specifications

TYPE	PERFORMANCE
Contact	Copper Alloy Per MIL-DTL-83513
Contact Finish	Gold per ASTM B488, Type II, Class 1.27, Code C Over Nickel Underplate
Insulator	Thermoplastic per MIL-DTL-83513
Interfacial Seal	Silicone Elastomer per A-A-59588
Hardware	Stainless Steel, 300 Series, Passivated per SAE AMS-2700

## Shell Options

MATERIAL	FINISH
Aluminum 6061	Electroless Nickel per SAE-AMS-2404
Stainless Steel, 300 Series	Passivated per SAE-AMS-2700

# LATCHING MICRO-D RIGHT ANGLE THRU-HOLE (TYPE H2)

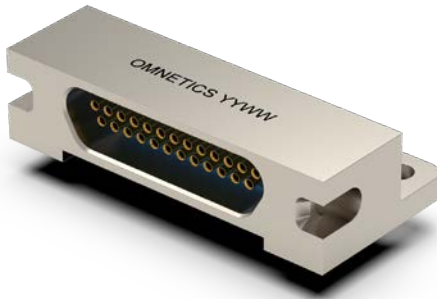

See page 161 for recommended board layout

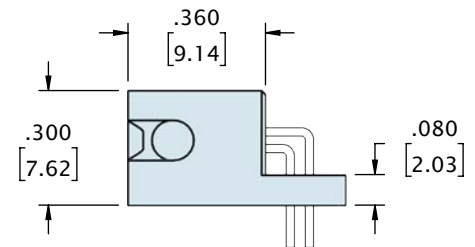
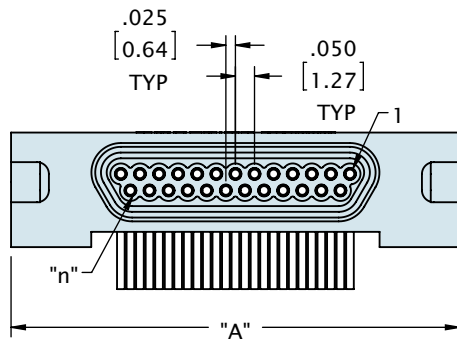
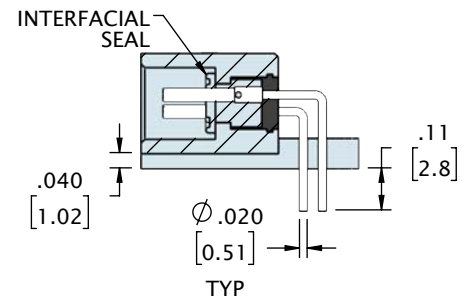
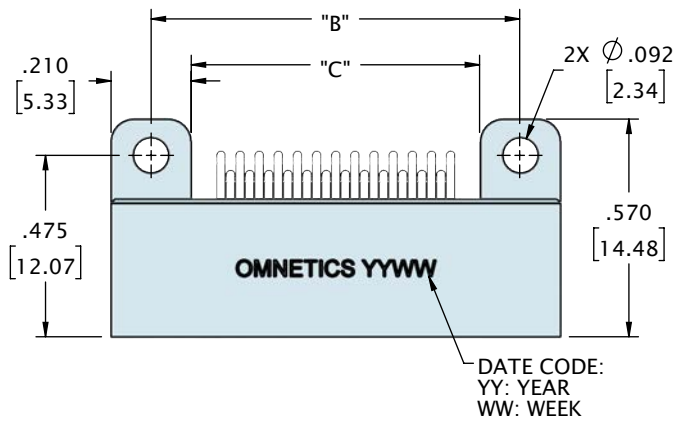

CONTACTS	ROWS	"A"	"B"	"C"
9	2	.775 [19.69]	.565 [14.35]	.355 [9.02]
15	2	.925 [23.50]	.715 [18.16]	.505 [12.83]
21	2	1.075 [27.31]	.865 [21.97]	.655 [16.64]
25	2	1.175 [29.85]	.965 [24.51]	.755 [19.18]
31	2	1.325 [33.66]	1.115 [28.32]	.905 [22.99]
37	2	1.475 [37.47]	1.265 [32.13]	1.055 [26.80]
51	2	1.825 [46.36]	1.615 [41.02]	1.405 [35.69]

DIMENSIONS IN [ ] ARE IN MILLIMETERS AND ARE FOR REFERENCE ONLY

# LATCHING MICRO-D RIGHT ANGLE THRU-HOLE (TYPE H2)

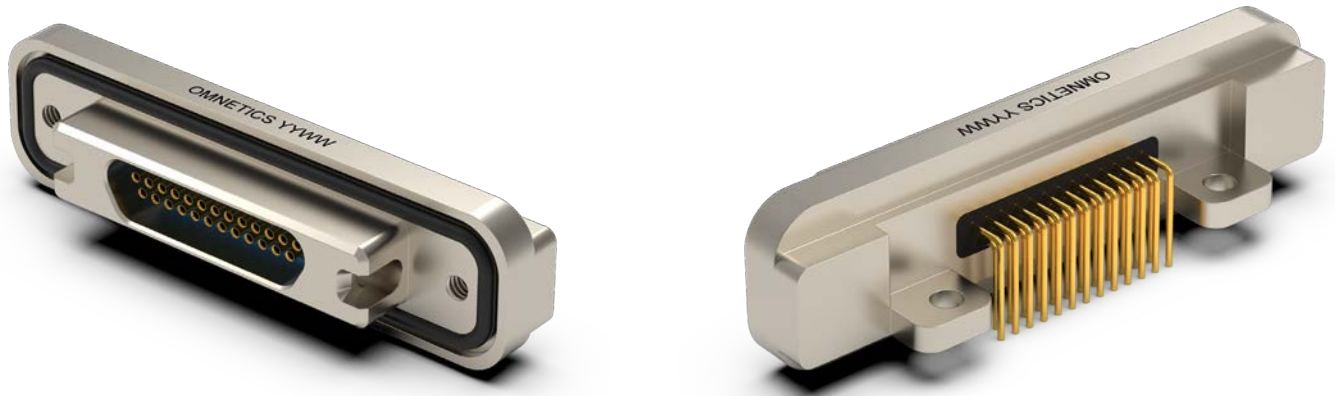

See page 161 for recommended board layout

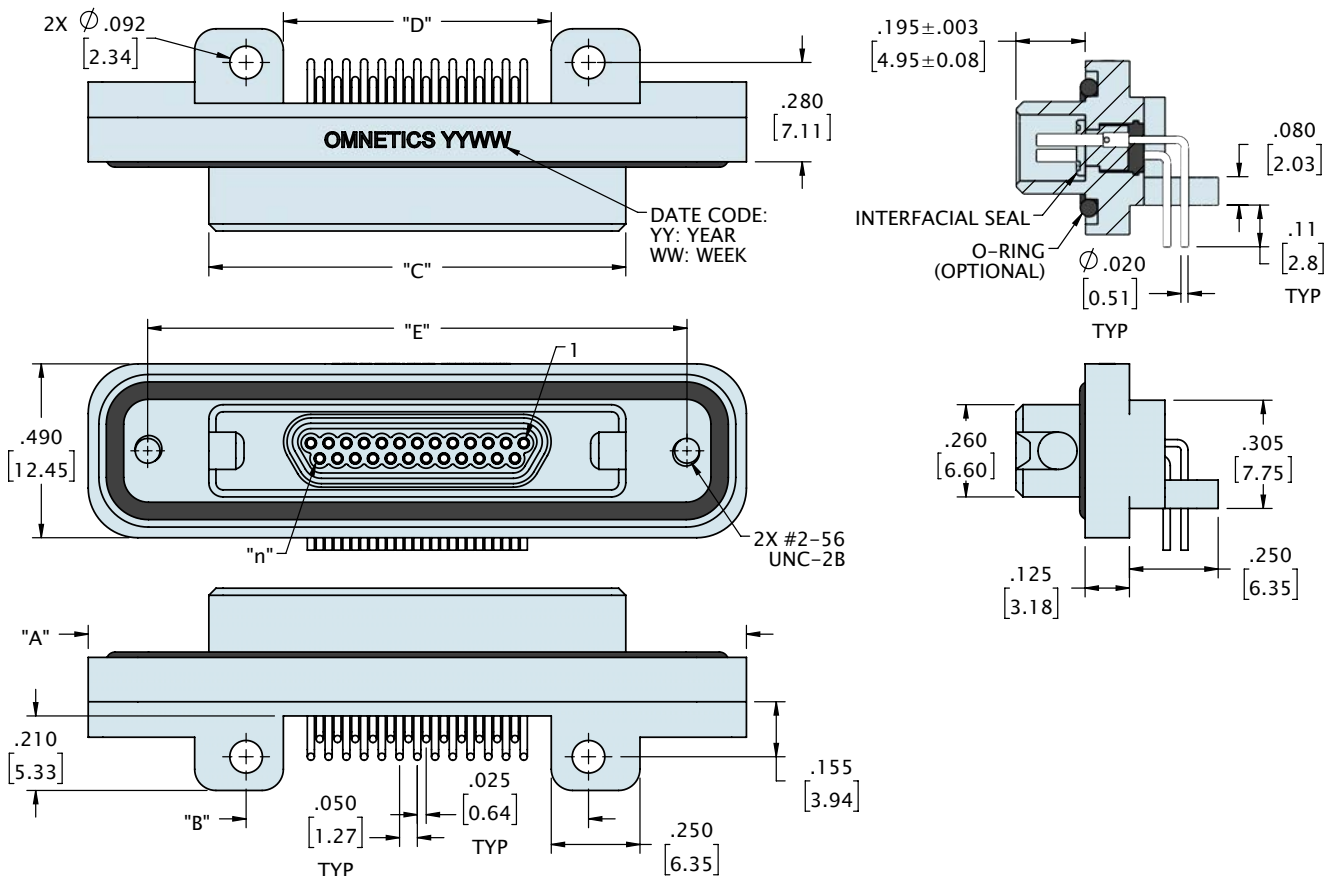

CONTACTS	ROWS	"A"	"B"	"C"	"D"	"E"
9	2	1.455 [36.96]	.565 [14.35]	.775 [19.69]	.355 [9.02]	1.120 [28.45]
15	2	1.605 [40.77]	.715 [18.16]	.925 [23.50]	.505 [12.83]	1.270 [32.26]
21	2	1.755 [44.58]	.865 [21.97]	1.075 [27.31]	.655 [16.64]	1.420 [36.07]
25	2	1.855 [47.12]	.965 [24.51]	1.175 [29.85]	.755 [19.18]	1.520 [38.61]
31	2	2.005 [50.93]	1.115 [28.32]	1.325 [33.66]	.905 [22.99]	1.670 [42.42]
37	2	2.155 [54.74]	1.265 [32.13]	1.475 [37.47]	1.055 [26.80]	1.820 [46.23]
51	2	2.505 [63.63]	1.615 [41.02]	1.825 [46.36]	1.405 [35.69]	2.170 [55.12]

DIMENSIONS IN [ ] ARE IN MILLIMETERS AND ARE FOR REFERENCE ONLY

## ORDERING GUIDE

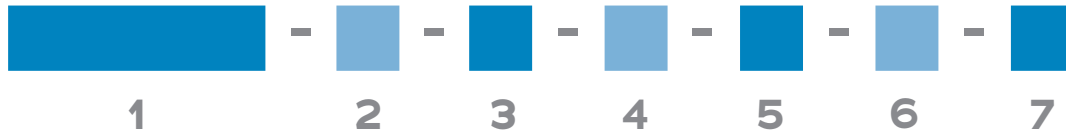

<b>1 Series</b>	LMDS Latching Metal Micro-D Socket	
<b>2 Number of Contacts</b>	009      015      021      025      031      037      051*	
<b>3 Termination Type</b>	H2 Right Angle Thru-Hole	
<b>4 Shell Material &amp; Finish</b>	N Aluminum Shell, Electroless Nickel Plated B Aluminium Shell, Black Anodized	CD Aluminium Shell, Cadmium Plated P Stainless Steel Shell, Passivated
<b>5 Common Options</b>	PA Panel Mount Rear, O-Ring HT High Temp Epoxy	PB Panel Mount, Rear RH RoHS Compliant
<b>6 Mod Codes</b>	M10 Keyed M50 Space Grade Micro-D, SPT1	M30 Ground Spring M53 Space Grade Micro-D, SPT2
<b>7 Special Instructions</b>	YYY Describe anything that is not covered in standard options	

# LATCHING SINGLE ROW MICRO-D DISCRETE LEADWIRE (TYPE WD)

Omnetics' **Latching Single Row Micro-D Connectors** offer a rugged quick latch system. They are built to meet or exceed the specifications of MIL-DTL-83513. Highly rugged and compact designs in shell styles from 9 to 37 contacts. The Single Row Latching Micro-D connectors incorporate Omnetics one-piece flex pin design for greater shock and vibration resistance. The high reliability gold plated flex pin is designed for >2,000 mating cycles.

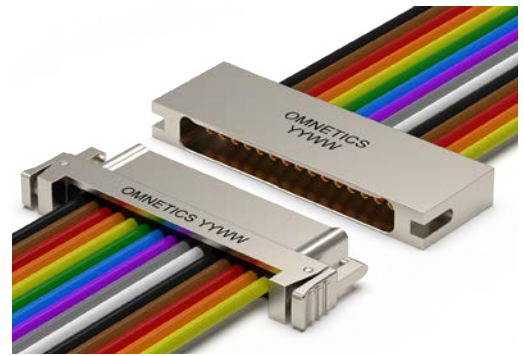

## Electro-Mechanical Specifications

TYPE	PERFORMANCE
Durability	> 2000 Mating Cycles min
Temperature	-55°C to +125°C (200 °C w/HTE)
Current rating	3 Amps per contact per MIL-DTL-83513
Voltage Rating (DWV)	600 VAC RMS Sea Level
Insulation Resistance	5,000 Megohms @ 500 VDC
Shock	50 g's with no discontinuities > 1 microsecond
Vibration	20 g's with no discontinuities > 1 microsecond
Thermal Vacuum Outgassing	1.0% max TML, 0.1% max CVCM - NASA SP-R-0022
Contact Resistance	26 milliohms (65 mV) max @ 2.5 Amps per MIL-DTL-83513
Mating/Unmating Force	3 oz. (.85g) typical per contact

## Material Specifications

TYPE	PERFORMANCE
Contact	Copper Alloy Per MIL-DTL-83513
Contact Finish	Gold per ASTM B488, Type II, Class 1.27, Code C Over Nickel Underplate
Insulator	Thermoplastic per MIL-DTL-83513
Hardware	Stainless Steel, 300 Series, Passivated per SAE AMS-2700

## Shell Options

MATERIAL	FINISH
Aluminum 6061	Electroless Nickel per SAE-AMS-2404
Stainless Steel, 300 Series	Passivated per SAE-AMS-2700

# LATCHING SINGLE ROW MICRO-D DISCRETE LEADWIRE (TYPE WD)

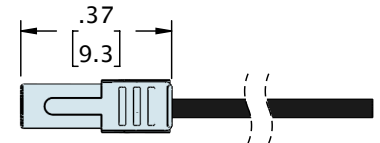
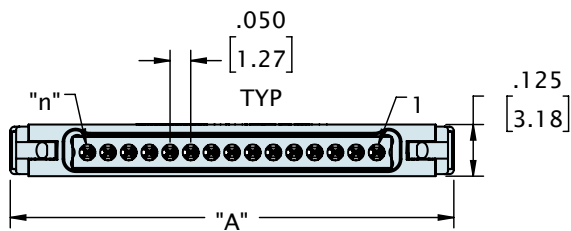
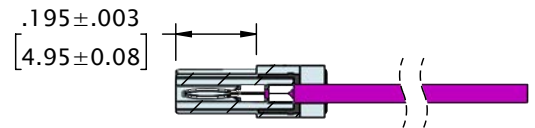
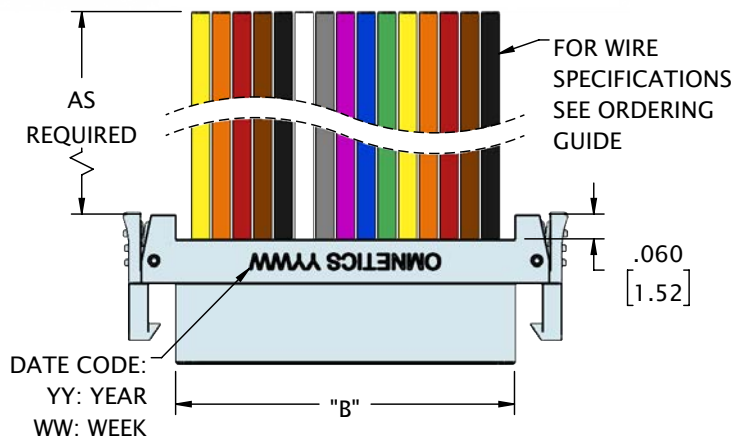
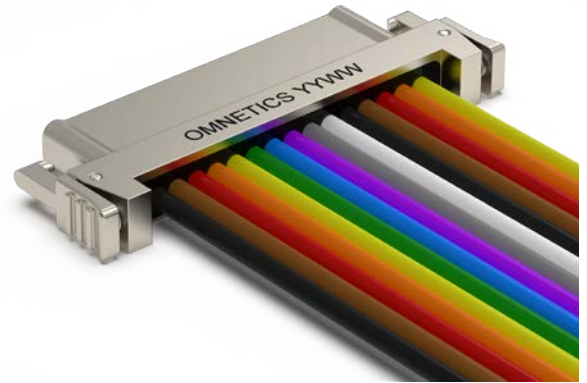

CONTACTS	ROWS	"A"	"B"
4	1	.52 [13.2]	.270 [6.86]
9	1	.77 [19.6]	.520 [13.21]
15	1	1.07 [27.2]	.820 [20.83]
21	1	1.37 [34.8]	1.120 [28.45]
25	1	1.57 [39.9]	1.320 [33.53]
31	1	1.87 [47.5]	1.620 [41.15]
37	1	2.17 [55.1]	1.920 [48.77]

DIMENSIONS IN [ ] ARE IN MILLIMETERS AND ARE FOR REFERENCE ONLY

# LATCHING SINGLE ROW MICRO-D DISCRETE LEADWIRE (TYPE WD)

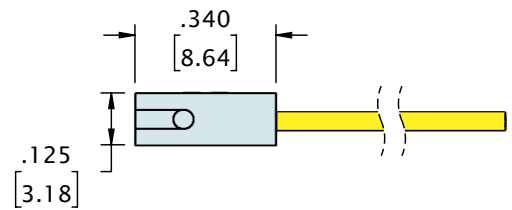
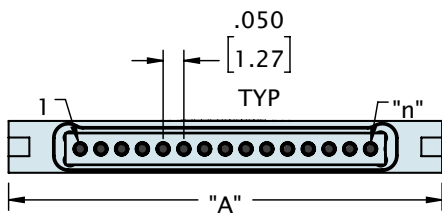
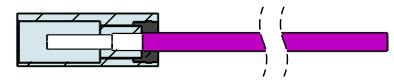
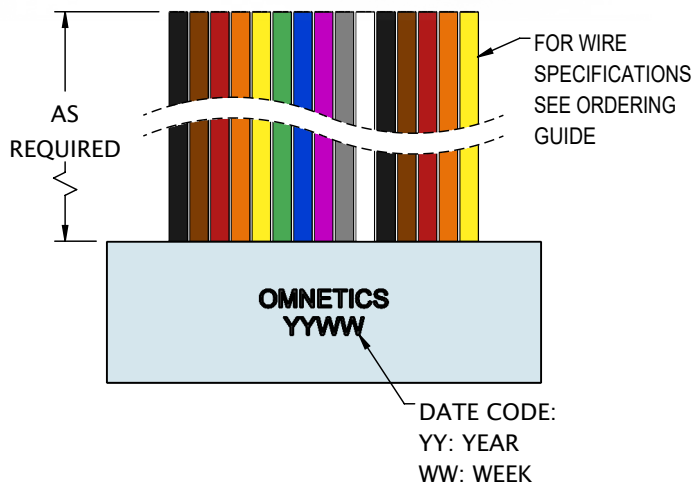
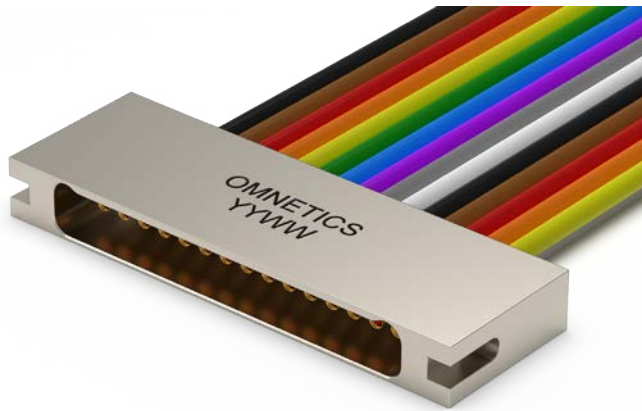

CONTACTS	ROWS	"A"
4	1	.495 [12.57]
9	1	.745 [18.92]
15	1	1.045 [26.54]
21	1	1.345 [34.16]
25	1	1.545 [39.24]
31	1	1.845 [46.86]
37	1	2.145 [54.48]

DIMENSIONS IN [ ] ARE IN MILLIMETERS AND ARE FOR REFERENCE ONLY



# LATCHING SINGLE ROW MICRO-D DISCRETE LEADWIRE (TYPE WD)

## ORDERING GUIDE



<b>1 Series</b>	<b>LMSP</b> Latching Single Row Micro-D Pin	<b>LMSS</b> Latching Single Row Micro-D Socket				
	LMSP - Latch Side (STD)			LMSS - Latch Receptacle side (STD)		
<b>2 Number of Contacts</b>	<b>04</b>	<b>09</b>	<b>15</b>	<b>21</b>	<b>25</b>	<b>31</b> <b>37</b>
<b>3 Termination Type</b>	<b>WD</b> Discrete Leadwire					
<b>4 Wire AWG</b>	<b>4</b> 24 AWG		<b>6</b> 26 AWG (STD)		<b>8</b> 28 AWG <b>0</b> 30 AWG	
<b>5 Wire Type</b>	<b>Q</b> Nema HP3 (STD)		<b>R</b> M22759/11		<b>S</b> M22759/33 <b>X</b> Other	
<b>6 Wire Length (inches)</b>	<b>18.0</b> 18.00 (STD)			<b>XX.X</b> Custom length		
<b>7 Color Scheme</b>	<b>1</b> 10 Repeating		<b>2</b> Blue	<b>3</b> White	<b>4</b> Non Repeating <b>5</b> Yellow	
<b>8 Shell Material &amp; Finish</b>	<b>N</b> Aluminum Shell, Electroless Nickel Plated			<b>CD</b> Aluminium Shell, Cadmium Plated		
	<b>B</b> Aluminium Shell, Black Anodized			<b>P</b> Stainless Steel Shell, Passivated		
<b>9 Common Options</b>	<b>IBS</b> Integrated Backshell (LMSP only)			<b>BSY</b> Custom Backshell (LMSP only)		
	<b>HT</b> High Temp Epoxy			<b>RH</b> RoHS Compliant		
<b>10 Shield / Jacket</b>	<b>D</b> Slip On Metal Braid		<b>E</b> Machine Braid	<b>F</b> Flexo Braid		
	<b>J</b> Nomex Braid		<b>ST</b> Shrink Tube			
<b>11 Mod Code</b>	<b>M10</b> Keyed			<b>M30</b> Ground Spring		
	<b>M50</b> Space Grade Micro-D, SPT1			<b>M53</b> Space Grade Micro-D, SPT2		
<b>12 Special Instructions</b>	<b>YYY</b> Describe anything that is not covered in standard options					

# LATCHING SINGLE ROW MICRO-D SOLDER CUP (TYPE SS)

Omnetics' **Latching Single Row Micro-D Solder Cup Connectors** offer a rugged quick latch system. These connector feature Solder Cup termination and are built to meet or exceed the specifications of MIL-DTL-83513. Highly rugged and compact designs in shell styles from 9 to 37 contacts. The Single Row Micro-D connectors incorporate Omnetics one-piece flex pin design for greater shock and vibration resistance. The high reliability gold plated flex pin is designed for >2,000 mating cycles.



## Electro-Mechanical Specifications

TYPE	PERFORMANCE
Durability	> 2000 Mating Cycles min
Temperature	-55°C to +125°C (200 °C w/HTE)
Current rating	3 Amps per contact per MIL-DTL-83513
Voltage Rating (DWV)	600 VAC RMS Sea Level
Insulation Resistance	5,000 Megohms @ 500 VDC
Shock	50 g's with no discontinuities > 1 microsecond
Vibration	20 g's with no discontinuities > 1 microsecond
Thermal Vacuum Outgassing	1.0% max TML, 0.1% max CVCM - NASA SP-R-0022
Contact Resistance	26 milliohms (65 mV) max @ 2.5 Amps per MIL-DTL-83513
Mating/Unmating Force	3 oz. (.85g) typical per contact

## Material Specifications

TYPE	PERFORMANCE
Contact	Copper Alloy Per MIL-DTL-83513
Contact Finish	Gold per ASTM B488, Type II, Class 1.27, Code C Over Nickel Underplate
Insulator	Thermoplastic per MIL-DTL-83513
Interfacial Seal	Silicone Elastomer per A-A-59588
Hardware	Stainless Steel, 300 Series, Passivated per SAE AMS-2700

## Shell Options

MATERIAL	FINISH
Aluminum 6061	Electroless Nickel per SAE-AMS-2404
Stainless Steel, 300 Series	Passivated per SAE-AMS-2700

# LATCHING SINGLE ROW MICRO-D SOLDER CUP (TYPE SS)

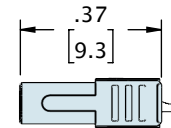
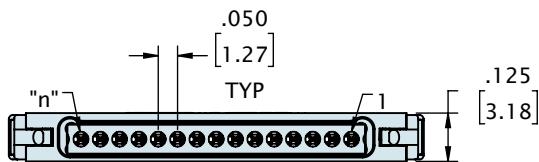
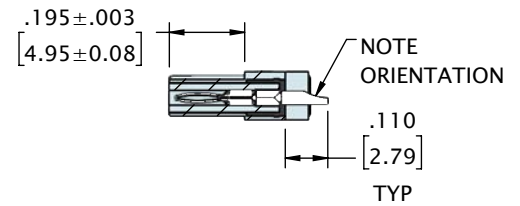
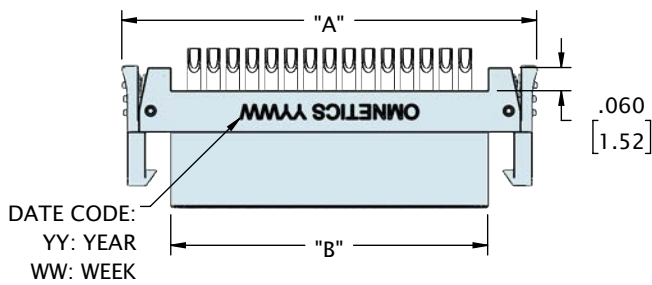

CONTACTS	ROWS	"A"	"B"
4	1	.52 [13.2]	.270 [6.86]
9	1	.77 [19.6]	.520 [13.21]
15	1	1.07 [27.2]	.820 [20.83]
21	1	1.37 [34.8]	1.120 [28.45]
25	1	1.57 [39.9]	1.320 [33.53]
31	1	1.87 [47.5]	1.620 [41.15]
37	1	2.17 [55.1]	1.920 [48.77]

DIMENSIONS IN [ ] ARE IN MILLIMETERS AND ARE FOR REFERENCE ONLY

# LATCHING SINGLE ROW MICRO-D SOLDER CUP (TYPE SS)

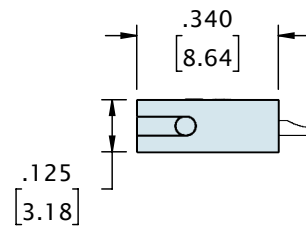
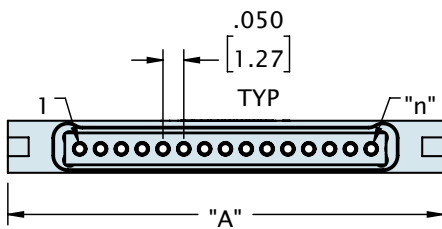
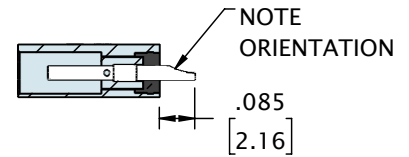
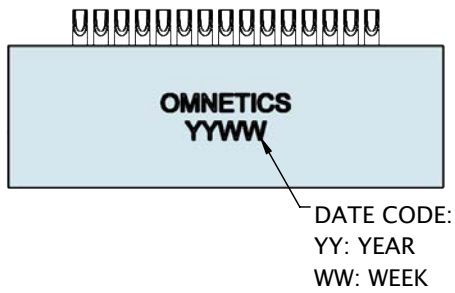
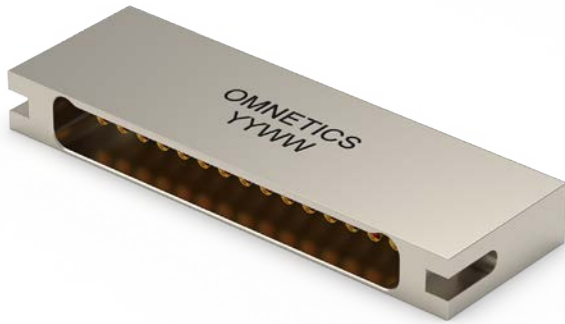

CONTACTS	ROWS	"A"
4	1	.495 [12.57]
9	1	.745 [18.92]
15	1	1.045 [26.54]
21	1	1.345 [34.16]
25	1	1.545 [39.24]
31	1	1.845 [46.86]
37	1	2.145 [54.48]

DIMENSIONS IN [ ] ARE IN MILLIMETERS AND ARE FOR REFERENCE ONLY

## ORDERING GUIDE

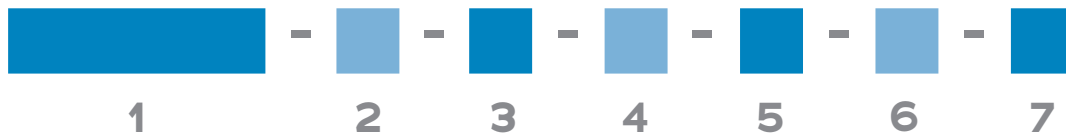

<b>1 Series</b>	<b>LMSP</b> Latching Single Row Micro-D Pin	<b>LMSS</b> Latching Single Row Micro-D Socket					
	LMSP - Latch Side (STD)		LMSS - Latch Receptacle side (STD)				
<b>2 Number of Contacts</b>	<b>04</b>	<b>09</b>	<b>15</b>	<b>21</b>	<b>25</b>	<b>31</b>	<b>37</b>
<b>3 Termination Type</b>	<b>SS</b> Soldercup						
<b>4 Shell Material &amp; Finish</b>	<b>N</b> Aluminum Shell, Electroless Nickel Plated			<b>CD</b> Aluminium Shell, Cadmium Plated			
	<b>B</b> Aluminium Shell, Black Anodized			<b>P</b> Stainless Steel Shell, Passivated			
<b>5 Common Options</b>	<b>BSY</b> Custom Backshell (LMSP only)		<b>HT</b> High Temp Epoxy		<b>RH</b> RoHS Compliant		
<b>6 Mod Code</b>	<b>M10</b> Keyed			<b>M30</b> Ground Spring			
	<b>M50</b> Space Grade Micro-D, SPT1			<b>M53</b> Space Grade Micro-D, SPT2			
<b>7 Special Instructions</b>	<b>YYY</b> Describe anything that is not covered in standard options						

# LATCHING SINGLE ROW MICRO-D 90° BOARD MOUNT (TYPE AA)

Omnetics' **Latching Single Row Micro-D 90° Board Mount Connectors** offer a rugged quick latch system. This connector features a compact board termination and are built to meet or exceed the specifications of MIL-DTL-83513. Highly rugged and compact designs in shell styles from 9 to 37 contacts. The Single Row Micro-D connectors incorporate Omnetics one-piece flex pin design for greater shock and vibration resistance. The high reliability gold plated flex pin is designed for >2,000 mating cycles.



## Electro-Mechanical Specifications

TYPE	PERFORMANCE
Durability	> 2000 Mating Cycles min
Temperature	-55°C to +125°C (200 °C w/HTE)
Current rating	3 Amps per contact per MIL-DTL-83513
Voltage Rating (DWV)	600 VAC RMS Sea Level
Insulation Resistance	5,000 Megohms @ 500 VDC
Shock	50 g's with no discontinuities > 1 microsecond
Vibration	20 g's with no discontinuities > 1 microsecond
Thermal Vacuum Outgassing	1.0% max TML, 0.1% max CVCM - NASA SP-R-0022
Contact Resistance	26 milliohms (65 mV) max @ 2.5 Amps per MIL-DTL-83513
Mating/Unmating Force	3 oz. (.85g) typical per contact

## Material Specifications

TYPE	PERFORMANCE
Contact	Copper Alloy Per MIL-DTL-83513
Contact Finish	Gold per ASTM B488, Type II, Class 1.27, Code C Over Nickel Underplate
Insulator	Thermoplastic per MIL-DTL-83513
Interfacial Seal	Silicone Elastomer per A-A-59588
Hardware	Stainless Steel, 300 Series, Passivated per SAE AMS-2700

## Shell Options

MATERIAL	FINISH
Aluminum 6061	Electroless Nickel per SAE-AMS-2404
Stainless Steel, 300 Series	Passivated per SAE-AMS-2700

# LATCHING SINGLE ROW MICRO-D 90° BOARD MOUNT (TYPE AA)

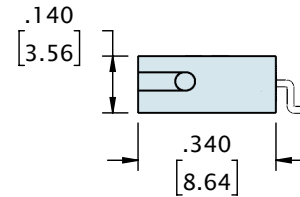
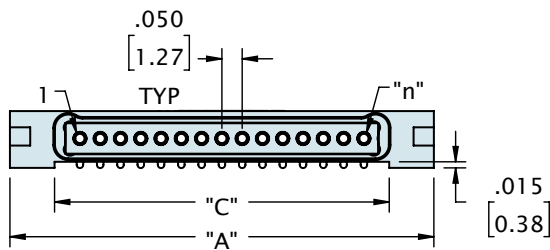
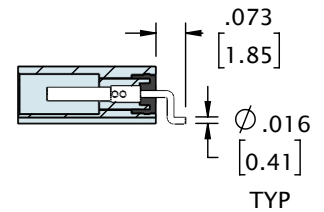
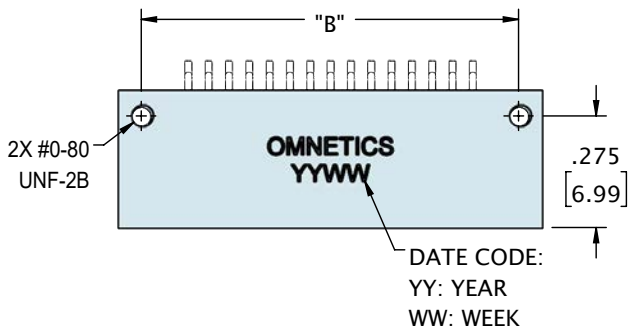

CONTACTS	ROWS	"A"	"B"	"C"
4	1	.495 [12.57]	.380 [9.65]	.275 [6.99]
9	1	.745 [18.92]	.630 [16.00]	.525 [13.34]
15	1	1.045 [26.54]	.930 [23.62]	.825 [20.96]
21	1	1.345 [34.16]	1.230 [31.24]	1.125 [28.58]
25	1	1.545 [39.24]	1.430 [36.32]	1.325 [33.66]
31	1	1.845 [46.86]	1.730 [43.94]	1.625 [41.28]
37	1	2.145 [54.48]	2.030 [51.56]	1.925 [48.90]

DIMENSIONS IN [ ] ARE IN MILLIMETERS AND ARE FOR REFERENCE ONLY

## LATCHING SINGLE ROW MICRO-D 90° BOARD MOUNT LAYOUT

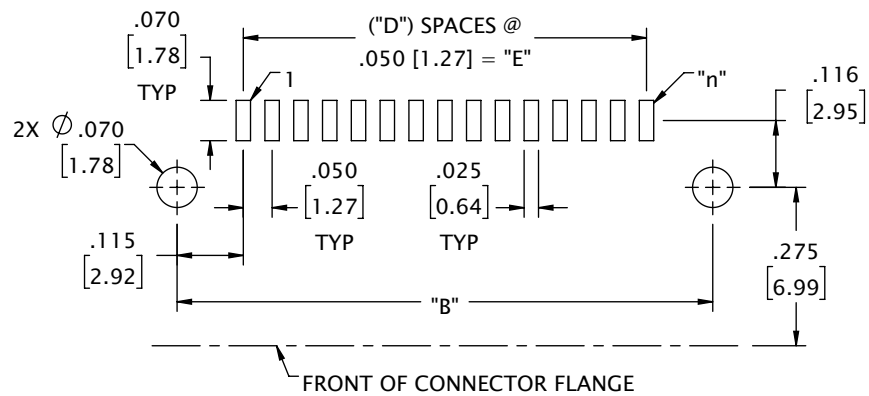

CONTACTS	ROWS	"B"	"D"	"E"
4	1	.380 [9.65]	3	.150 [3.81]
9	1	.630 [16.00]	8	.400 [10.16]
15	1	.930 [23.62]	14	.700 [17.78]
21	1	1.230 [31.24]	20	1.000 [25.40]
25	1	1.430 [36.32]	24	1.200 [30.48]
31	1	1.730 [43.94]	30	1.500 [38.10]
37	1	2.030 [51.56]	36	1.800 [45.72]

DIMENSIONS IN [ ] ARE IN MILLIMETERS AND ARE FOR REFERENCE ONLY



## ORDERING GUIDE

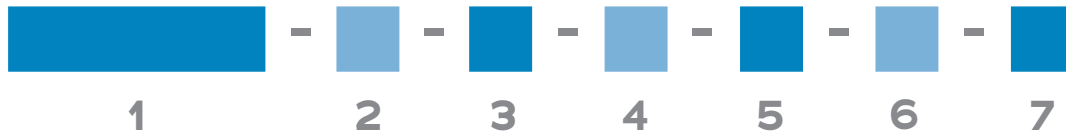

<b>1 Series</b>	LMSS Latching Micro-D Single Row Socket				
<b>2 Number of Contacts</b>	O4    O9    15    21    25    31    37				
<b>3 Termination Type</b>	AA 90° Board Mount				
<b>4 Shell Material &amp; Finish</b>	<table style="width: 100%; border: none;"> <tr> <td style="width: 50%;">N Aluminum Shell, Electroless Nickel Plated</td> <td>CD Aluminium Shell, Cadmium Plated</td> </tr> <tr> <td>B Aluminium Shell, Black Anodized</td> <td>P Stainless Steel Shell, Passivated</td> </tr> </table>	N Aluminum Shell, Electroless Nickel Plated	CD Aluminium Shell, Cadmium Plated	B Aluminium Shell, Black Anodized	P Stainless Steel Shell, Passivated
N Aluminum Shell, Electroless Nickel Plated	CD Aluminium Shell, Cadmium Plated				
B Aluminium Shell, Black Anodized	P Stainless Steel Shell, Passivated				
<b>5 Common Options</b>	<table style="width: 100%; border: none;"> <tr> <td style="width: 50%;">HT High Temp Epoxy</td> <td>RH RoHS Compliant</td> </tr> </table>	HT High Temp Epoxy	RH RoHS Compliant		
HT High Temp Epoxy	RH RoHS Compliant				
<b>6 Mod Codes</b>	<table style="width: 100%; border: none;"> <tr> <td style="width: 50%;">M10 Keyed</td> <td>M30 Ground Spring</td> </tr> <tr> <td>M50 Space Grade Micro-D, SPT1</td> <td>M53 Space Grade Micro-D, SPT2</td> </tr> </table>	M10 Keyed	M30 Ground Spring	M50 Space Grade Micro-D, SPT1	M53 Space Grade Micro-D, SPT2
M10 Keyed	M30 Ground Spring				
M50 Space Grade Micro-D, SPT1	M53 Space Grade Micro-D, SPT2				
<b>7 Special Instructions</b>	YYY Describe anything that is not covered in standard options				

# LATCHING MICRO-D SINGLE ROW STRAIGHT THRU-HOLE (TYPE DD)

Omnetics' **Latching Single Row Micro-D Straight Thru-Hole Board Mount Connectors** offer a rugged quick latch system. This connector features a compact board termination and are built to meet or exceed the specifications of MIL-DTL-83513. Highly rugged and compact designs in shell styles from 9 to 37 contacts. The Single Row Micro-D connectors incorporate Omnetics one-piece flex pin design for greater shock and vibration resistance. The high reliability gold plated flex pin is designed for >2,000 mating cycles.



## Electro-Mechanical Specifications

TYPE	PERFORMANCE
Durability	> 2000 Mating Cycles min
Temperature	-55°C to +125°C (200 °C w/HTE)
Current rating	3 Amps per contact per MIL-DTL-83513
Voltage Rating (DWV)	600 VAC RMS Sea Level
Insulation Resistance	5,000 Megohms @ 500 VDC
Shock	50 g's with no discontinuities > 1 microsecond
Vibration	20 g's with no discontinuities > 1 microsecond
Thermal Vacuum Outgassing	1.0% max TML, 0.1% max CVCM - NASA SP-R-0022
Contact Resistance	26 milliohms (65 mV) max @ 2.5 Amps per MIL-DTL-83513
Mating/Unmating Force	3 oz. (.85g) typical per contact

## Material Specifications

TYPE	PERFORMANCE
Contact	Copper Alloy Per MIL-DTL-83513
Contact Finish	Gold per ASTM B488, Type II, Class 1.27, Code C Over Nickel Underplate
Insulator	Thermoplastic per MIL-DTL-83513
Interfacial Seal	Silicone Elastomer per A-A-59588
Hardware	Stainless Steel, 300 Series, Passivated per SAE AMS-2700

## Shell Options

MATERIAL	FINISH
Aluminum 6061	Electroless Nickel per SAE-AMS-2404
Stainless Steel, 300 Series	Passivated per SAE-AMS-2700

# LATCHING MICRO-D SINGLE ROW STRAIGHT THRU-HOLE (TYPE DD)

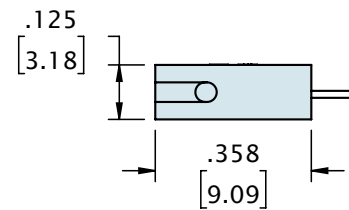
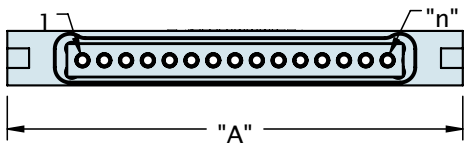
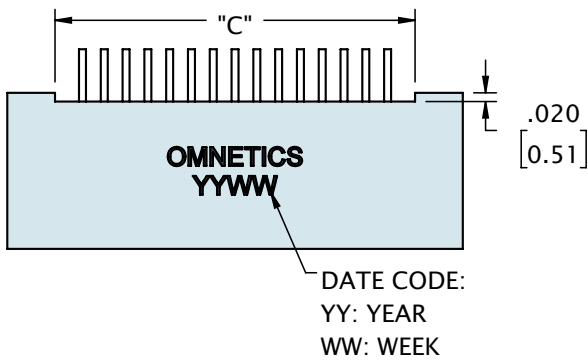
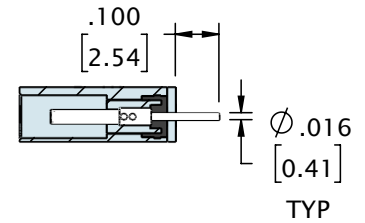
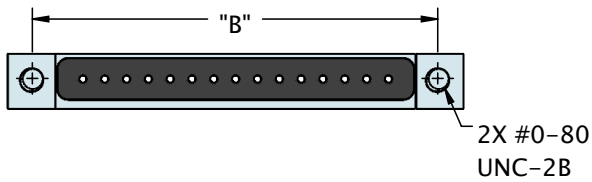
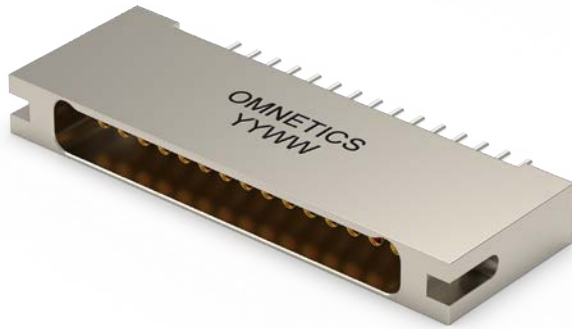

CONTACTS	ROWS	"A"	"B"	"C"
4	1	.495 [12.57]	.380 [9.65]	.276 [7.01]
9	1	.745 [18.92]	.630 [16.00]	.526 [13.36]
15	1	1.045 [26.54]	.930 [23.62]	.826 [20.98]
21	1	1.345 [34.16]	1.230 [31.24]	1.126 [28.60]
25	1	1.545 [39.24]	1.430 [36.32]	1.326 [33.68]
31	1	1.845 [46.86]	1.730 [43.94]	1.626 [41.30]
37	1	2.145 [54.48]	2.030 [51.56]	1.926 [48.92]

DIMENSIONS IN [ ] ARE IN MILLIMETERS AND ARE FOR REFERENCE ONLY

## LATCHING MICRO-D SINGLE ROW STRAIGHT THRU-HOLE BOARD MOUNT LAYOUT

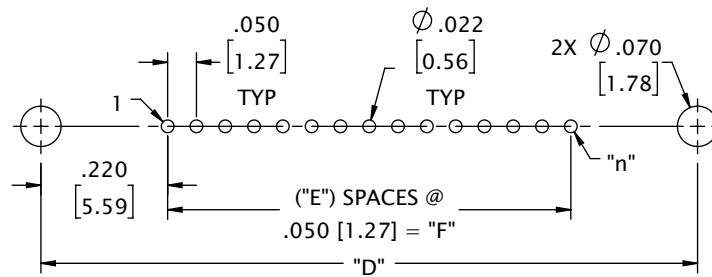

CONTACTS	ROWS	"B"	"E"	"F"
4	1	.590 [14.99]	3	.150 [3.81]
9	1	.840 [21.34]	8	.400 [10.16]
15	1	1.140 [28.96]	14	.700 [17.78]
21	1	1.440 [36.58]	20	1.000 [25.40]
25	1	1.640 [41.66]	24	1.200 [30.48]
31	1	1.940 [49.28]	30	1.500 [38.10]
37	1	2.240 [56.90]	36	1.800 [45.72]

DIMENSIONS IN [ ] ARE IN MILLIMETERS AND ARE FOR REFERENCE ONLY

## ORDERING GUIDE

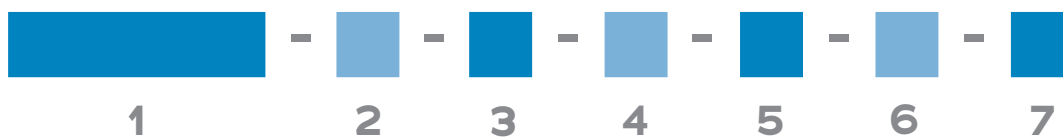

<b>1 Series</b>	LMSS Latching Micro-D Single Row Socket	
<b>2 Number of Contacts</b>	O4    O9    15    21    25    31    37	
<b>3 Termination Type</b>	DD Straight Thru-Hole	
<b>4 Shell Material &amp; Finish</b>	N Aluminum Shell, Electroless Nickel Plated B Aluminium Shell, Black Anodized	CD Aluminium Shell, Cadmium Plated P Stainless Steel Shell, Passivated
<b>5 Common Options</b>	HT High Temp Epoxy	RH RoHS Compliant
<b>6 Mod Codes</b>	M10 Keyed M50 Space Grade Micro-D, SPT1	M30 Ground Spring M53 Space Grade Micro-D, SPT2
<b>7 Special Instructions</b>	YYY Describe anything that is not covered in standard options	

# LATCHING MICRO-D SINGLE ROW RIGHT ANGLE THRU-HOLE (TYPE H2)

Omnetics' **Latching Single Row Micro-D Right Angle Thru-Hole Board Mount Connectors** offer a rugged quick latch system. This connector features a compact board termination and are built to meet or exceed the specifications of MIL-DTL-83513. Highly rugged and compact designs in shell styles from 9 to 37 contacts. The Single Row Micro-D connectors incorporate Omnetics one-piece flex pin design for greater shock and vibration resistance. The high reliability gold plated flex pin is designed for >2,000 mating cycles.

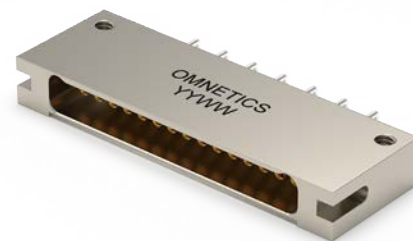

## Electro-Mechanical Specifications

TYPE	PERFORMANCE
Durability	> 2000 Mating Cycles min
Temperature	-55°C to +125°C (200 °C w/HTE)
Current rating	3 Amps per contact per MIL-DTL-83513
Voltage Rating (DWV)	600 VAC RMS Sea Level
Insulation Resistance	5,000 Megohms @ 500 VDC
Shock	50 g's with no discontinuities > 1 microsecond
Vibration	20 g's with no discontinuities > 1 microsecond
Thermal Vacuum Outgassing	1.0% max TML, 0.1% max CVCM - NASA SP-R-0022
Contact Resistance	26 milliohms (65 mV) max @ 2.5 Amps per MIL-DTL-83513
Mating/Unmating Force	3 oz. (.85g) typical per contact

## Material Specifications

TYPE	PERFORMANCE
Contact	Copper Alloy Per MIL-DTL-83513
Contact Finish	Gold per ASTM B488, Type II, Class 1.27, Code C Over Nickel Underplate
Insulator	Thermoplastic per MIL-DTL-83513
Interfacial Seal	Silicone Elastomer per A-A-59588
Hardware	Stainless Steel, 300 Series, Passivated per SAE AMS-2700

## Shell Options

MATERIAL	FINISH
Aluminum 6061	Electroless Nickel per SAE-AMS-2404
Stainless Steel, 300 Series	Passivated per SAE-AMS-2700

# LATCHING MICRO-D SINGLE ROW RIGHT ANGLE THRU-HOLE (TYPE H2)

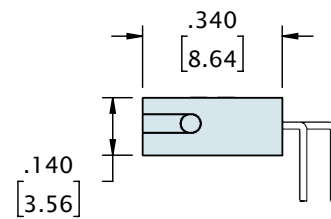
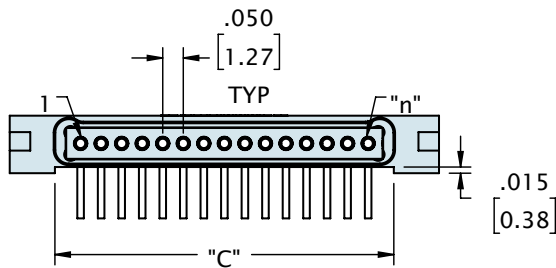
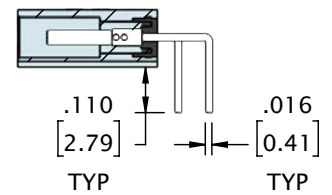
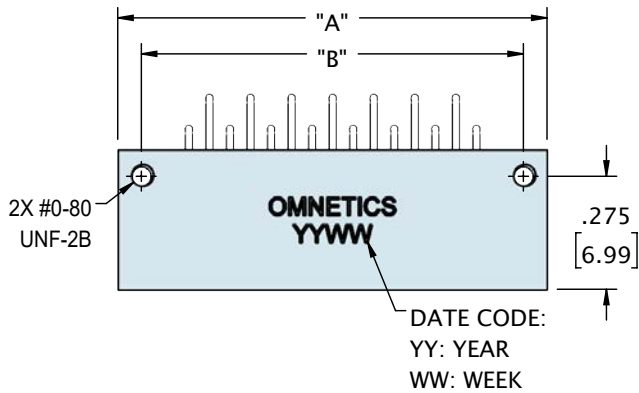
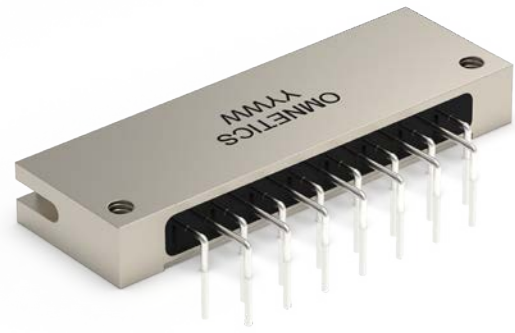

CONTACTS	ROWS	"A"	"B"	"C"
4	1	.495 [12.57]	.380 [9.65]	.275 [6.99]
9	1	.745 [18.92]	.630 [16.00]	.525 [13.34]
15	1	1.045 [26.54]	.930 [23.62]	.825 [20.96]
21	1	1.345 [34.16]	1.230 [31.24]	1.125 [28.58]
25	1	1.545 [39.24]	1.430 [36.32]	1.325 [33.66]
31	1	1.845 [46.86]	1.730 [43.94]	1.625 [41.28]
37	1	2.145 [54.48]	2.030 [51.56]	1.925 [48.90]

DIMENSIONS IN [ ] ARE IN MILLIMETERS AND ARE FOR REFERENCE ONLY

## LATCHING MICRO-D SINGLE ROW RIGHT ANGLE THRU-HOLE BOARD MOUNT LAYOUT

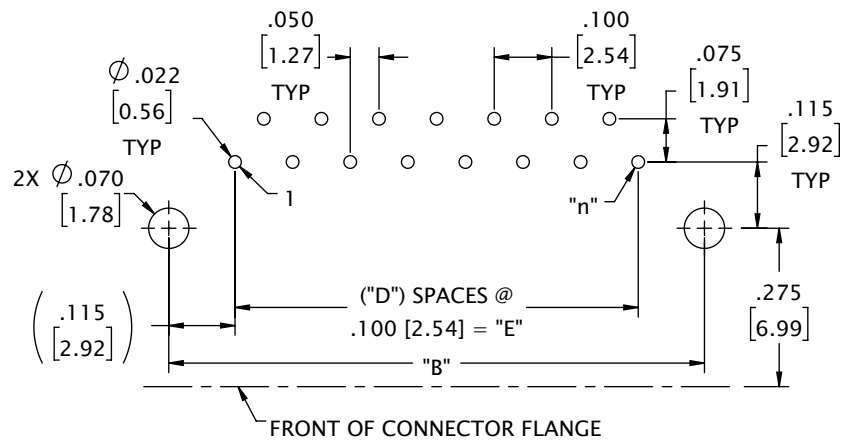

CONTACTS	ROWS	"B"	"D"	"E"
4	1	.380 [9.65]	3	.300 [7.62]
9	1	.630 [16.00]	8	.800 [20.32]
15	1	.930 [23.62]	14	1.400 [35.56]
21	1	1.230 [31.24]	20	2.000 [50.80]
25	1	1.430 [36.32]	24	2.400 [60.96]
31	1	1.730 [43.94]	30	3.000 [76.20]
37	1	2.030 [51.56]	36	3.600 [91.44]

DIMENSIONS IN [ ] ARE IN MILLIMETERS AND ARE FOR REFERENCE ONLY



## ORDERING GUIDE

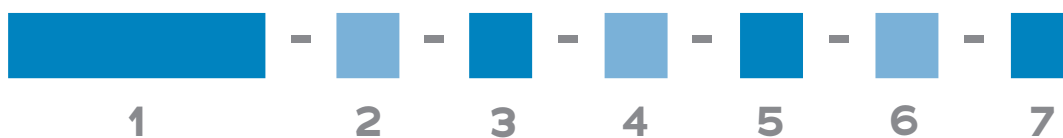

<b>1 Series</b>	LMSS Latching Micro-D Single Row Socket				
<b>2 Number of Contacts</b>	O4    O9    15    21    25    31    37				
<b>3 Termination Type</b>	H2 Right Angle Thru-Hole				
<b>4 Shell Material &amp; Finish</b>	<table style="width: 100%; border: none;"> <tr> <td style="width: 50%;">N Aluminum Shell, Electroless Nickel Plated</td> <td style="width: 50%;">CD Aluminium Shell, Cadmium Plated</td> </tr> <tr> <td>B Aluminium Shell, Black Anodized</td> <td>P Stainless Steel Shell, Passivated</td> </tr> </table>	N Aluminum Shell, Electroless Nickel Plated	CD Aluminium Shell, Cadmium Plated	B Aluminium Shell, Black Anodized	P Stainless Steel Shell, Passivated
N Aluminum Shell, Electroless Nickel Plated	CD Aluminium Shell, Cadmium Plated				
B Aluminium Shell, Black Anodized	P Stainless Steel Shell, Passivated				
<b>5 Common Options</b>	<table style="width: 100%; border: none;"> <tr> <td style="width: 50%;">HT High Temp Epoxy</td> <td style="width: 50%;">RH RoHS Compliant</td> </tr> </table>	HT High Temp Epoxy	RH RoHS Compliant		
HT High Temp Epoxy	RH RoHS Compliant				
<b>6 Mod Codes</b>	<table style="width: 100%; border: none;"> <tr> <td style="width: 50%;">M10 Keyed</td> <td style="width: 50%;">M30 Ground Spring</td> </tr> <tr> <td>M50 Space Grade Micro-D, SPT1</td> <td>M53 Space Grade Micro-D, SPT2</td> </tr> </table>	M10 Keyed	M30 Ground Spring	M50 Space Grade Micro-D, SPT1	M53 Space Grade Micro-D, SPT2
M10 Keyed	M30 Ground Spring				
M50 Space Grade Micro-D, SPT1	M53 Space Grade Micro-D, SPT2				
<b>7 Special Instructions</b>	YYY Describe anything that is not covered in standard options				

# MICRO-D JUMPERS

Omnetics **Micro-D Jumpers** save time and money with these back-to-back wire assemblies. These Micro-D connectors use Omnetics high-reliability flex pin design and feature crimp wire terminations and epoxy encapsulation. All jumper assemblies are 100% checked for continuity and resistance.

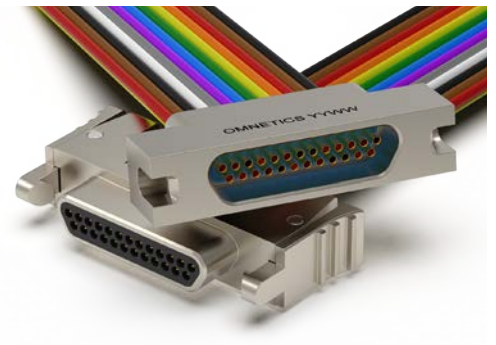

## Electro-Mechanical Specifications

TYPE	PERFORMANCE
Durability	> 2000 Mating Cycles min
Temperature	-55°C to +125°C (200 °C w/HTE)
Current rating	3 Amps per contact per MIL-DTL-83513
Voltage Rating (DWV)	600 VAC RMS Sea Level
Insulation Resistance	5,000 Megohms @ 500 VDC
Shock	50 g's with no discontinuities > 1 microsecond
Vibration	20 g's with no discontinuities > 1 microsecond
Thermal Vacuum Outgassing	1.0% max TML, 0.1% max CVCM - NASA SP-R-0022
Contact Resistance	26 milliohms (65 mV) max @ 2.5 Amps per MIL-DTL-83513
Mating/Unmating Force	3 oz. (.85g) typical per contact

## Material Specifications

TYPE	PERFORMANCE
Contact	Copper Alloy Per MIL-DTL-83513
Contact Finish	Gold per ASTM B488, Type II, Class 1.27, Code C Over Nickel Underplate
Insulator	Thermoplastic per MIL-DTL-83513
Interfacial Seal	Silicone Elastomer per A-A-59588
Hardware	Stainless Steel, 300 Series, Passivated per SAE AMS-2700

## Shell Options

MATERIAL	FINISH
Aluminum 6061	Electroless Nickel per SAE-AMS-2404
Stainless Steel, 300 Series	Passivated per SAE-AMS-2700

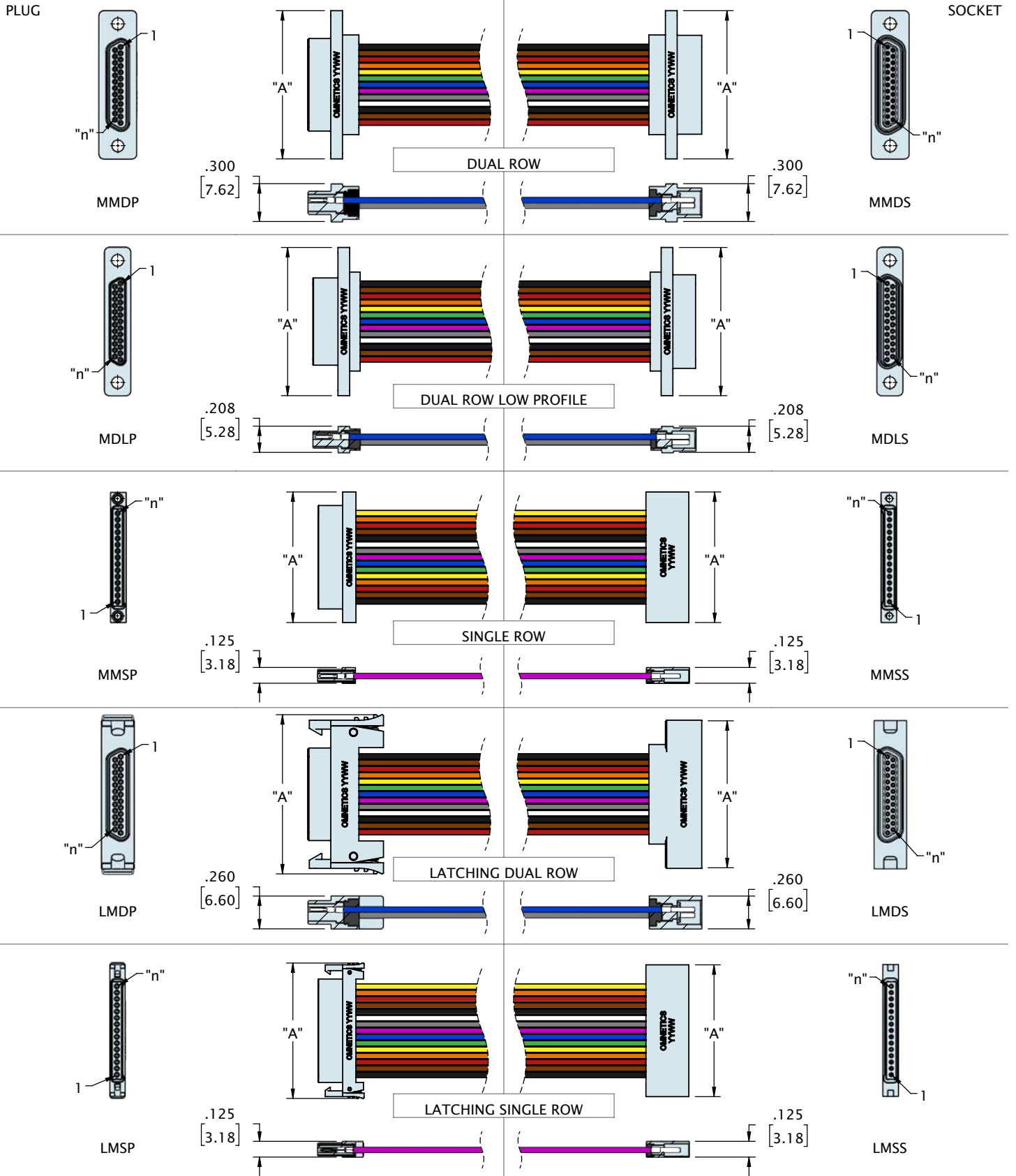

# MICRO-D JUMPERS

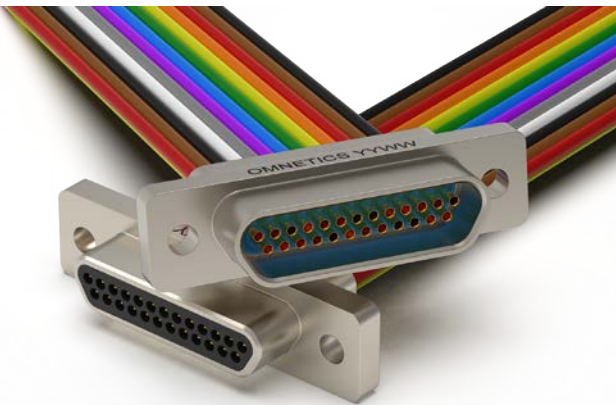
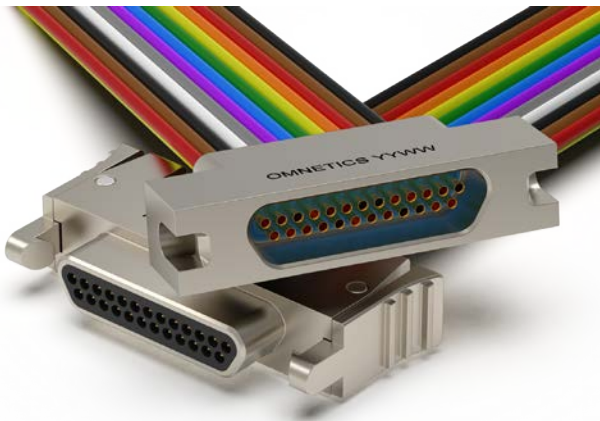

"A" DIMENSION		DUAL ROW CONNECTORS					
CONTACTS	ROWS	MMDP	MMDS	MDLP	MDLS	LMDP	LMDS
9	2	.775 [19.69]	.775 [19.69]	.775 [19.69]	.775 [19.69]	.86 [21.8]	.775 [19.69]
15	2	.925 [23.50]	.925 [23.50]	.925 [23.50]	.925 [23.50]	1.01 [25.7]	.925 [23.50]
21	2	1.075 [27.31]	1.075 [27.31]	1.075 [27.31]	1.075 [27.31]	1.16 [29.5]	1.075 [27.31]
25	2	1.175 [29.85]	1.175 [29.85]	1.175 [29.85]	1.175 [29.85]	1.26 [32.0]	1.175 [29.85]
31	2	1.325 [33.66]	1.325 [33.66]	1.325 [33.66]	1.325 [33.66]	1.41 [35.8]	1.325 [33.66]
37	2	1.475 [37.47]	1.475 [37.47]	1.475 [37.47]	1.475 [37.47]	1.56 [39.6]	1.475 [37.47]
51	2	1.825 [46.36]	1.825 [46.36]	N/A	N/A	1.91 [48.5]	1.825 [46.36]
51	3	1.425 [36.20]	1.425 [36.20]	N/A	N/A	N/A	N/A
69	3	1.725 [43.82]	1.725 [43.82]	N/A	N/A	N/A	N/A
100	4	2.160 [54.86]	2.160 [54.86]	N/A	N/A	N/A	N/A

"A" DIMENSION		SINGLE ROW CONNECTORS			
CONTACTS	ROWS	MMSP	MMSS	LMSP	LMSS
4	1	.485 [12.32]	.485 [12.32]	.52 [13.2]	.495 [12.57]
9	1	.735 [18.67]	.735 [18.67]	.77 [19.6]	.745 [18.92]
15	1	1.035 [26.29]	1.035 [26.29]	1.07 [27.2]	1.045 [26.54]
21	1	1.335 [33.91]	1.335 [33.91]	1.37 [34.8]	1.345 [34.16]
25	1	1.535 [38.99]	1.535 [38.99]	1.57 [39.9]	1.545 [39.24]
31	1	1.835 [46.61]	1.835 [46.61]	1.87 [47.5]	1.845 [46.86]
37	1	2.135 [54.23]	2.135 [54.23]	2.17 [55.1]	2.145 [54.48]

DIMENSIONS IN [ ] ARE IN MILLIMETERS AND ARE FOR REFERENCE ONLY

ORDERING GUIDE

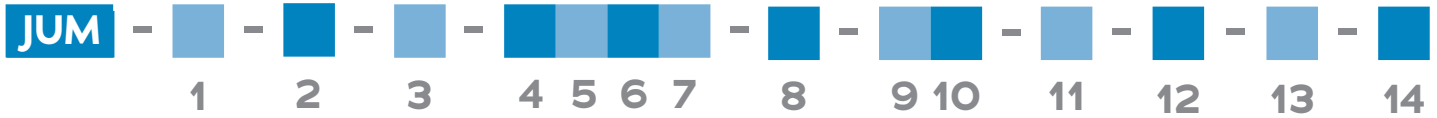

<b>1</b> Number of Contacts	004* 009 015 021 025 031 037 051** 069*** 100***
<b>2</b> Connector 1	See page 153
<b>3</b> Connector 2	See page 153
<b>4</b> Termination Type	WD Discrete Leadwire with Male and/or Female connectors
<b>5</b> Wire AWG	4 24 AWG 6 26 AWG (STD) 8 28 AWG 0 30 AWG
<b>6</b> Wire Type	Q Nema HP3 (STD) R M22759/11 S M22759/33 X Other
<b>7</b> Wire Length (inches)	18.0 18.00 (STD) XX.X Custom length
<b>8</b> Color Scheme	C 10 Repeating colors per MIL STD 681 Y All Other Wire Colors
<b>9</b> Shell Material & Finish	N Aluminium Shell, Electroless Nickel Plated CD Aluminium Shell, Cadmium Plated B Aluminium Shell, Black Anodized P Stainless Steel Shell, Passivated
<b>10</b> Hardware	00 None, Ø .092 Hole 01 Fixed Jack-posts 02 Jackscrews, STD Length, Hex Head 03 Jackscrews, STD Length, Slotted 04 Jackscrews, Long Length, Hex 05 Jackscrews, Long Length, Slotted 06 Float Mount, Front Mounted 07 Float Mount, Rear Mounted
<b>11</b> Common Options	PA Panel Mount Rear, O-Ring PB Panel Mount, Rear BS1 45 Degree Round Entry, Micro-D Backshell IBS Integrated Backshell BS2 Straight Oval Entry, Micro-D Backshell BSY Custom Backshell BS3 90 Degree Oval Entry, Micro-D Backshell ETH End Threaded Hole BS4 45 Degree Elliptical Entry, Micro-D Backshell HT High Temp Epoxy BS5 Straight Elliptical Entry, Split Micro-D Backshell RH RoHS Compliant BS6 45 Degree Round Entry, Split Micro-D Backshell
<b>12</b> Shield / Jacket	D Slip On Metal Braid E Machine Braid F Flexo Braid J Nomex Braid ST Shrink Tube
<b>13</b> Mod Codes	M10 Keyed M30 Ground Spring M50 Space Grade Micro-D, SPT1 M53 Space Grade Micro-D, SPT2
<b>14</b> Special Instructions	YYY Describe anything that is not covered in standard options

## Electro-Mechanical Specifications

TYPE	PERFORMANCE
Durability	500 Mating Cycles min
Temperature	-55°C to +125°C
Insulation Resistance	5,000 Megohms @ 500 VDC
Shock	50 g's with no discontinuities > 1 microsecond
Vibration	20 g's with no discontinuities > 1 microsecond

## Signal Contacts

TYPE	PERFORMANCE
Dielectric Withstand Voltage	600 VAC RMS @sea level
Contact Resistance	26 milliohms (65 mV) max @2.5 amp
Current Rating	3 amps per contact
Mating/Unmating Force	10 oz. max per contact

## Power Contacts

TYPE	PERFORMANCE
Dielectric Withstand Voltage	1000 VAC RMS @sea level
Contact Resistance	7 milliohms (55 mV drop) max @2.5 amps
Current Rating	7.5 amps per contact
Mating/Unmating Force	16/10 oz. max per contact (respectively)

## Material Specifications

TYPE	PERFORMANCE
Contact	Copper Alloy Per MIL-DTL-83513 (Signal) or SAE AS39029 (Power)
Signal Contact Finish	Gold per ASTM B488, Type II, Class 1.27, Code C Over Nickel Underplate
Power Contact Finish	Gold per MIL-G-45204, Type II, Grade C, Class 1, Code C Over Nickel Underplate
Insulator	PPS or PEEK
Hardware	Stainless Steel, 300 Series, Passivated per SAE AMS-2700
Aluminium with Nickel Plating	Alloy 6061 per SAE AMS-QQ-Q-200/8, Nickel per SAE-AMS-2404
Stainless Steel	300 Series, Passivated per SAE AMS-2700
Aluminium with Cadmium Plating	Alloy 6061 per SAE AMS-QQ-A-200/8, Cadmium With Yellow Chromate Conversion per SAE AMS-QQ-P-416, Type II, Class 3 Over Nickel Underplate



LMDS-02P05-H2



MMDP-03P11-WD

MAX # OF SIGNALS GIVEN THE BELOW # OF POWER (ALL POWER ON ONE SIDE) [a]												
HOUSING SIZE	HOUSING ROWS	1	2	3	4	5	6	7	8	9	10	11
9	2	3	1									
15	2	9	5	1								
21	2	15	11	7	1							
25	2	19	15	11	5	1						
31	2	25	21	17	11	7	3	1				
37	2	31	27	23	17	13	9	5	1			
51	2	45	41	37	31	27	23	19	15	11	5	1

MAX # OF POWER, NO SIGNAL [b]		
HOUSING SIZE	HOUSING ROWS	#
9	2	2
15	2	3
21	2	4
25	2	5
31	2	7
37	2	8
51	2	11

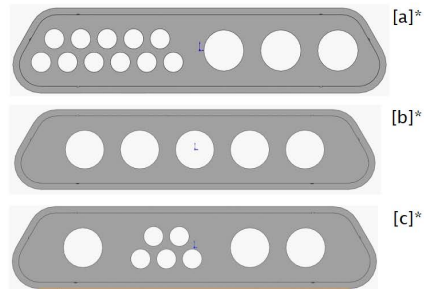

MAX # OF SIGNALS GIVEN THE BELOW # OF POWER (POWER SPLIT - BOTH ENDS) [c]												
HOUSING SIZE	HOUSING ROWS	1	2	3	4	5	6	7	8	9	10	11
9	2											
15	2	3	1									
21	2	9	5	1								
25	2	13	9	5	1							
31	2	19	15	11	7	3	1					
37	2	25	21	17	13	9	5	1				
51	2	39	35	31	27	23	19	13	9	5	1	

\*ALL CONFIGURATIONS PICTURED ARE STANDARD SIZE 25 MICRO-D'S

## METAL MICRO-D HORIZONTAL SURFACE MOUNT (HO)

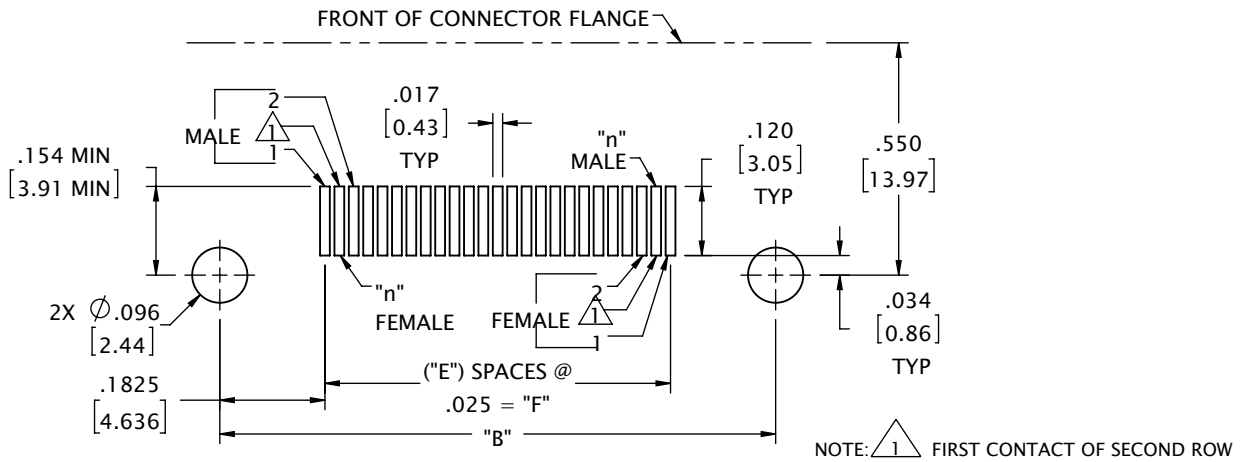

CONTACTS	ROWS	"B"	"E"	"F"
9	2	.565 [14.35]	8	.200 [5.08]
15	2	.715 [18.16]	14	.350 [8.89]
21	2	.865 [21.97]	20	.500 [12.70]
25	2	.965 [24.51]	24	.600 [15.24]
31	2	1.115 [28.32]	30	.750 [19.05]
37	2	1.265 [32.13]	36	.900 [22.86]
51	2	1.615 [41.02]	50	1.250 [31.75]

DIMENSIONS IN [ ] ARE IN MILLIMETERS AND ARE FOR REFERENCE ONLY

## METAL MICRO-D VERTICAL SURFACE MOUNT (VV)

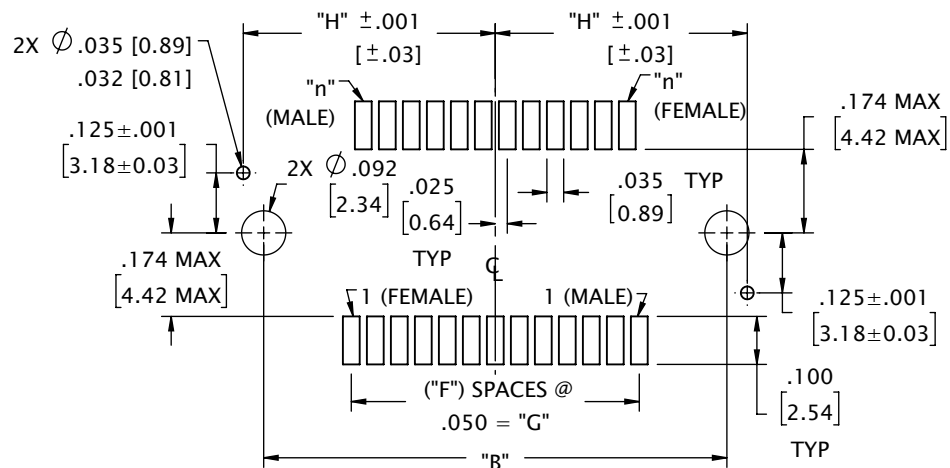

CONTACTS	ROWS	"B"	"F"	"G"	"H"
9	2	.565 [14.35]	4	.200 [5.08]	.325 [8.26]
15	2	.715 [18.16]	7	.350 [8.89]	.400 [10.16]
21	2	.865 [21.97]	10	.500 [12.70]	.475 [12.07]
25	2	.965 [24.51]	12	.600 [15.24]	.525 [13.34]
31	2	1.115 [28.32]	15	.750 [19.05]	.600 [15.24]
37	2	1.265 [32.13]	18	.900 [22.86]	.675 [17.15]
51	2	1.615 [41.02]	25	1.250 [31.75]	.850 [21.59]

DIMENSIONS IN [ ] ARE IN MILLIMETERS AND ARE FOR REFERENCE ONLY



## METAL MICRO-D CARD EDGE SURFACE MOUNT (CO)

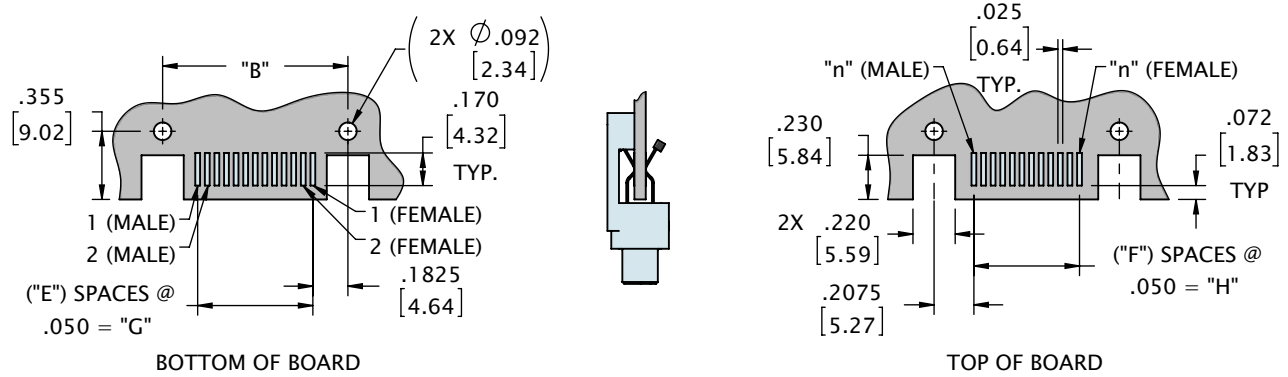

CONTACTS	ROWS	"E"	"F"	"B"	"G"	"H"
9	2	4	3	.565 [14.35]	.200 [5.08]	.150 [3.81]
15	2	7	6	.715 [18.16]	.350 [8.89]	.300 [7.62]
21	2	10	9	.865 [21.97]	.500 [12.70]	.450 [11.43]
25	2	12	11	.965 [24.51]	.600 [15.24]	.550 [13.97]
31	2	15	14	1.115 [28.32]	.750 [19.05]	.700 [17.78]
37	2	18	17	1.265 [32.13]	.900 [22.86]	.850 [21.59]
51	2	25	24	1.615 [41.02]	1.250 [31.75]	1.200 [30.48]

DIMENSIONS IN [ ] ARE IN MILLIMETERS AND ARE FOR REFERENCE ONLY

## METAL MICRO-D FLEX TAIL (FF)

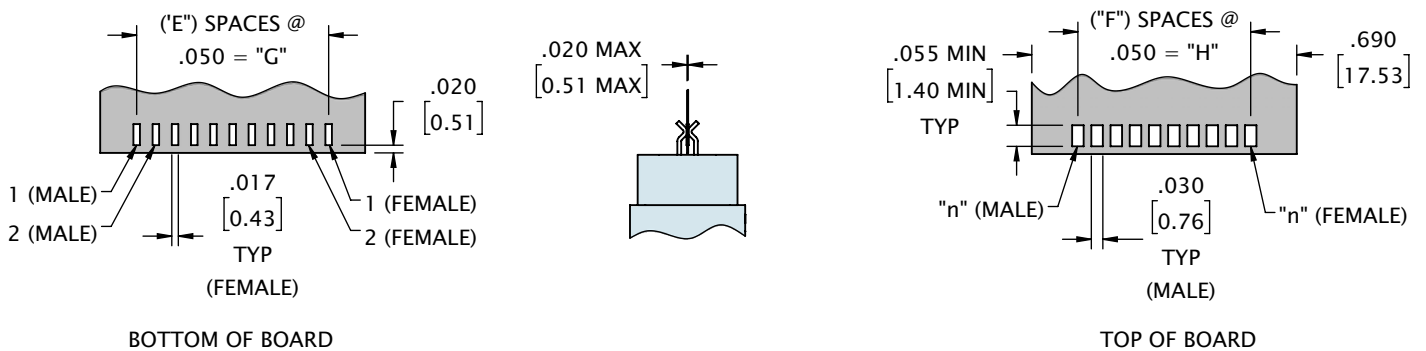

CONTACTS	ROWS	"E"	"F"	"G"	"H"
9	2	4	3	.200 [5.08]	.150 [3.81]
15	2	7	6	.350 [8.89]	.300 [7.62]
21	2	10	9	.500 [12.70]	.450 [11.43]
25	2	12	11	.600 [15.24]	.550 [13.97]
31	2	15	14	.750 [19.05]	.700 [17.78]
37	2	18	17	.900 [22.86]	.850 [21.59]
51	2	25	24	1.250 [31.75]	1.200 [30.48]

DIMENSIONS IN [ ] ARE IN MILLIMETERS AND ARE FOR REFERENCE ONLY

## METAL MICRO-D STRAIGHT THRU-HOLE (DD)

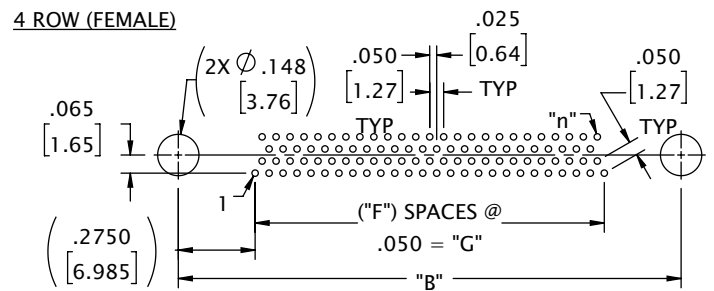
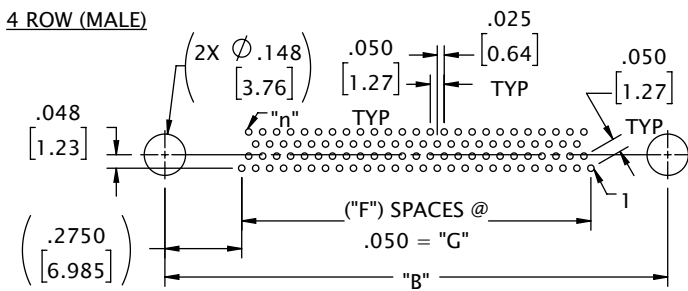
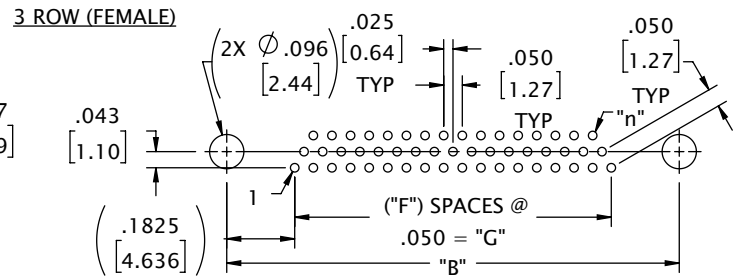
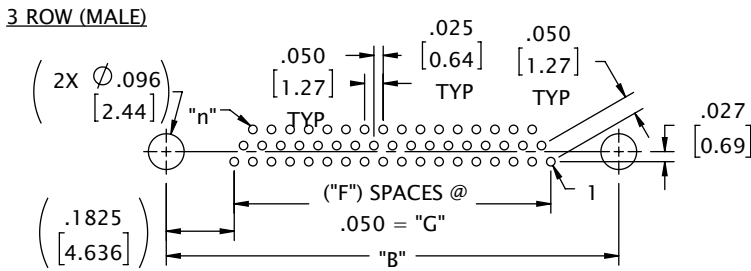
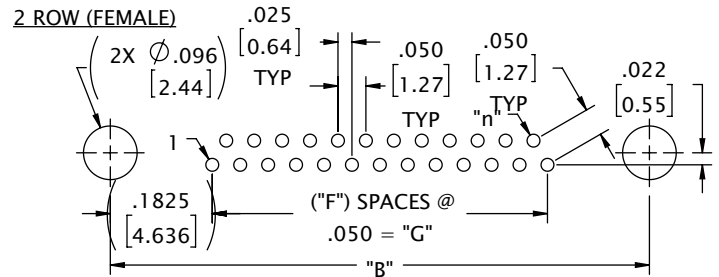
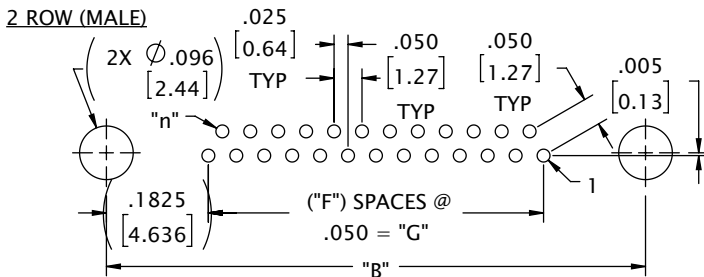

CONTACTS	ROWS	"B"	"F"	"G"
9	2	.565 [14.35]	4	.200 [5.08]
15	2	.715 [18.16]	7	.350 [8.89]
21	2	.865 [21.97]	10	.500 [12.70]
25	2	.965 [24.51]	12	.600 [15.24]
31	2	1.115 [28.32]	15	.750 [19.05]
37	2	1.265 [32.13]	18	.900 [22.86]
51	2	1.615 [41.02]	25	1.250 [31.75]
51	3	1.215 [30.86]	17	.850 [21.59]
69	3	1.515 [38.48]	23	1.150 [29.21]
100	4	1.800 [45.72]	25	1.250 [31.75]

DIMENSIONS IN [ ] ARE IN MILLIMETERS AND ARE FOR REFERENCE ONLY

## METAL MICRO-D RIGHT ANGLE THRU-HOLE (H2)

2 ROW

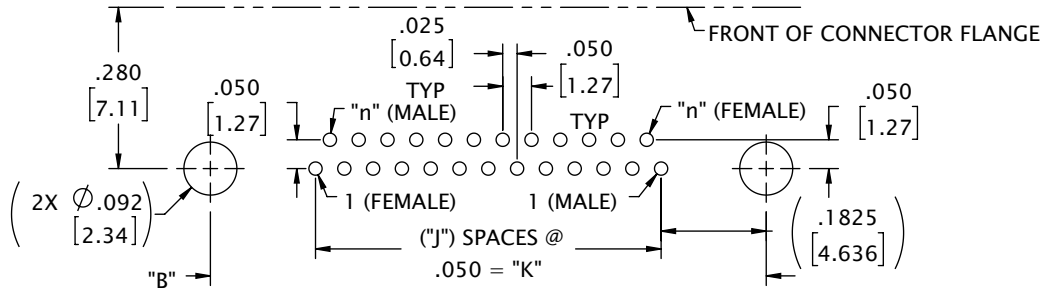

3 ROW

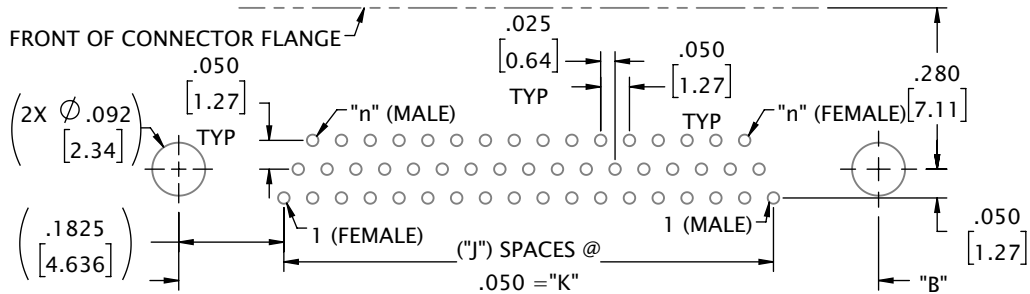

4 ROW

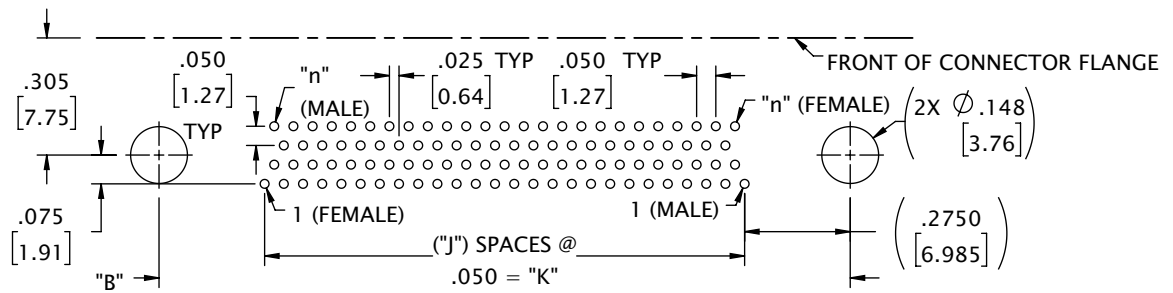

CONTACTS	ROWS	"B"	"F"	"G"
9	2	.565 [14.35]	4	.200 [5.08]
15	2	.715 [18.16]	7	.350 [8.89]
21	2	.865 [21.97]	10	.500 [12.70]
25	2	.965 [24.51]	12	.600 [15.24]
31	2	1.115 [28.32]	15	.750 [19.05]
37	2	1.265 [32.13]	18	.900 [22.86]
51	2	1.615 [41.02]	25	1.250 [31.75]
51	3	1.215 [30.86]	17	.850 [21.59]
69	3	1.515 [38.48]	23	1.150 [29.21]
100	4	1.800 [45.72]	25	1.250 [31.75]

DIMENSIONS IN [ ] ARE IN MILLIMETERS AND ARE FOR REFERENCE ONLY

# METAL MICRO-D BOARD MOUNT LAYOUT

## METAL MICRO-D NARROW RIGHT ANGLE .100 (SR1)

9 CONTACT  
PLUG

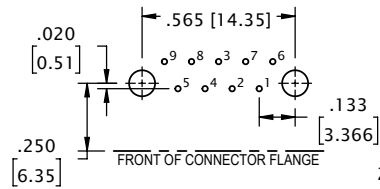

9 CONTACT  
RECEPTACLE

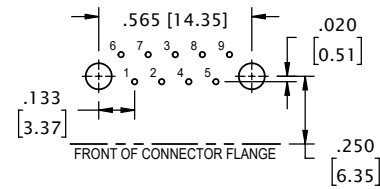

15 CONTACT  
PLUG

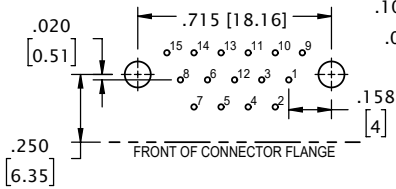

15 CONTACT  
RECEPTACLE

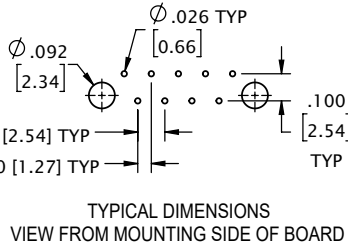
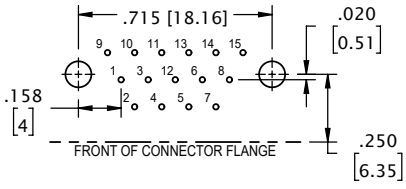

21 CONTACT  
PLUG

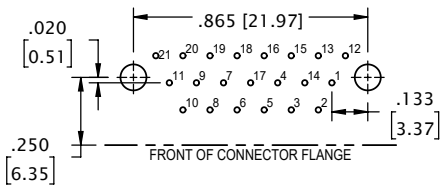

21 CONTACT  
RECEPTACLE

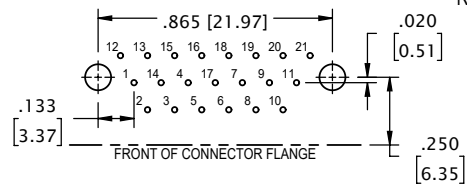

25 CONTACT  
PLUG

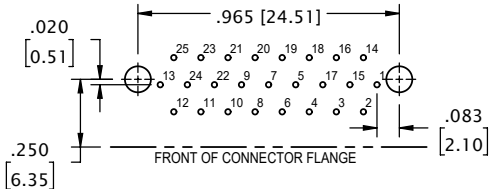

25 CONTACT  
RECEPTACLE

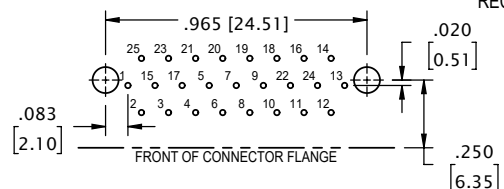

31 CONTACT  
PLUG

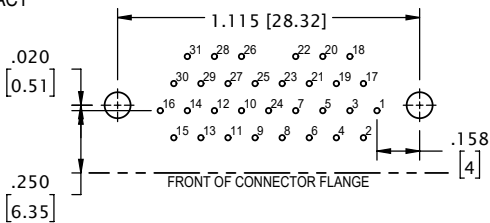

31 CONTACT  
RECEPTACLE

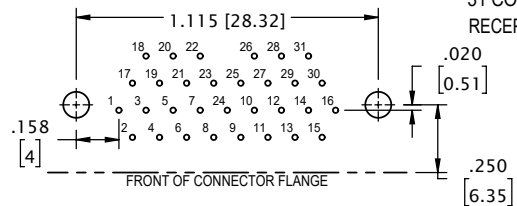

37 CONTACT  
PLUG

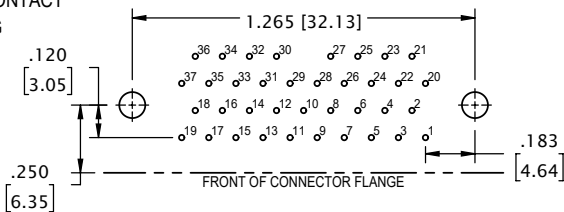

37 CONTACT  
RECEPTACLE

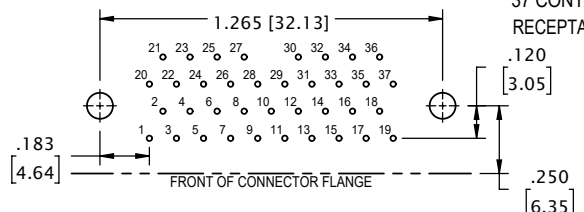

51 CONTACT  
PLUG

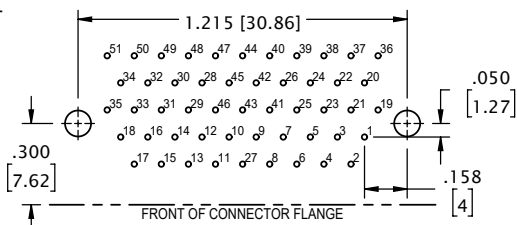

51 CONTACT  
RECEPTACLE

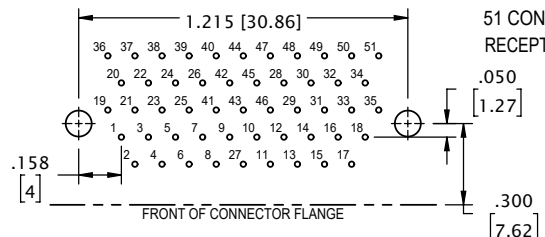

# METAL MICRO-D BOARD MOUNT LAYOUT

## METAL SHELL MICRO-D STANDARD VERTICAL BOARD MOUNT .075 (TYPE SV7)

9 CONTACT  
PLUG

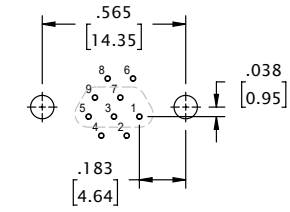

9 CONTACT  
RECEPTACLE

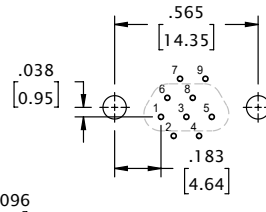

TYPICAL DIMENSIONS

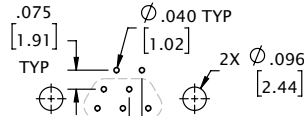

15 CONTACT  
PLUG

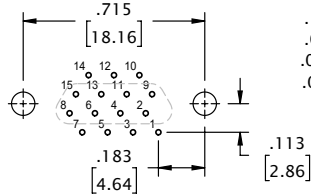

15 CONTACT  
RECEPTACLE

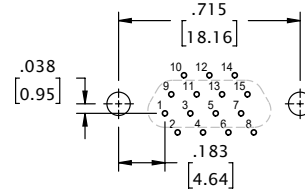

.100 [2.54] TYP  
.075 [1.91] TYP  
.050 [1.27] TYP  
.025 [0.64] TYP

VIEW FROM MOUNTING  
SIDE OF BOARD  
NOTE MATE ORIENTATION

21 CONTACT  
PLUG

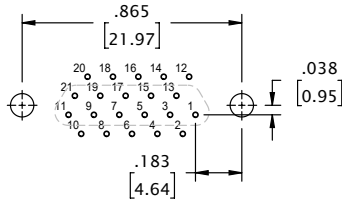

21 CONTACT  
RECEPTACLE

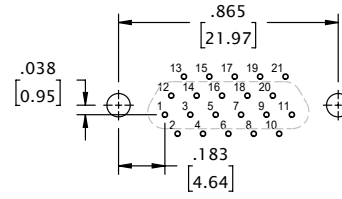

25 CONTACT  
PLUG

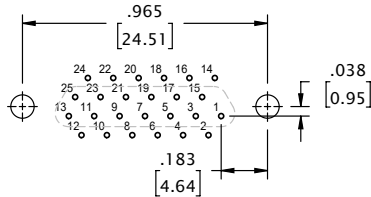

25 CONTACT  
RECEPTACLE

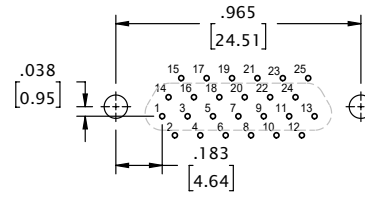

31 CONTACT  
PLUG

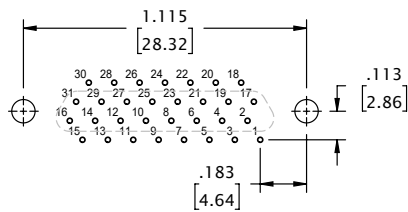

31 CONTACT  
RECEPTACLE

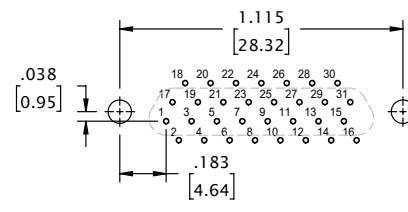

37 CONTACT  
PLUG

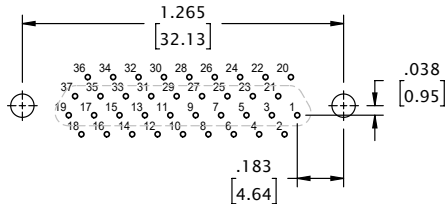

37 CONTACT  
RECEPTACLE

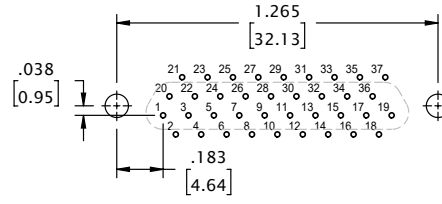

# MICRO-D CONNECTOR SAVER (TYPE Z)

Omnetics' **Dual Row Connector Savers** preserve connectors installed in complex critical systems in the military, aerospace, and harsh-environment industries where interconnects experience frequent disconnection for testing and other service disruptions. Our solution extends the lifespan of high-reliability connectors with the same precision design we integrate into all of our termination products. This cost-effective, user-friendly, and rugged utility product helps protect installed connectors from damage or wear. It is available in a wide range of options and configurations to match your system's needs.



## Electro-Mechanical Specifications

TYPE	PERFORMANCE
Durability	> 2000 Mating Cycles min
Temperature	-55°C to +125°C (200 °C w/HTE)
Current rating	3 Amps per contact per MIL-DTL-83513
Voltage Rating (DWV)	600 VAC RMS Sea Level
Insulation Resistance	5,000 Megohms @ 500 VDC
Shock	50 g's with no discontinuities > 1 microsecond
Vibration	20 g's with no discontinuities > 1 microsecond
Thermal Vacuum Outgassing	1.0% max TML, 0.1% max CVCM - NASA SP-R-0022
Contact Resistance	26 milliohms (65 mV) max @ 2.5 Amps per MIL-DTL-83513
Mating/Unmating Force	3 oz. (.85g) typical per contact

## Material Specifications

TYPE	PERFORMANCE
Contact	Copper Alloy Per MIL-DTL-83513
Contact Finish	Gold per ASTM B488, Type II, Class 1.27, Code C Over Nickel Underplate
Insulator	Thermoplastic per MIL-DTL-83513
Interfacial Seal	Silicone Elastomer per A-A-59588
Hardware	Stainless Steel, 300 Series, Passivated per SAE AMS-2700

## Shell Options

MATERIAL	FINISH
Aluminum 6061	Electroless Nickel per SAE-AMS-2404
Stainless Steel, 300 Series	Passivated per SAE-AMS-2700

## METAL SHELL MICRO-D CONNECTOR SAVER

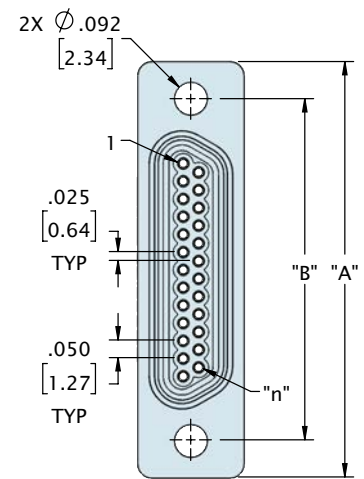
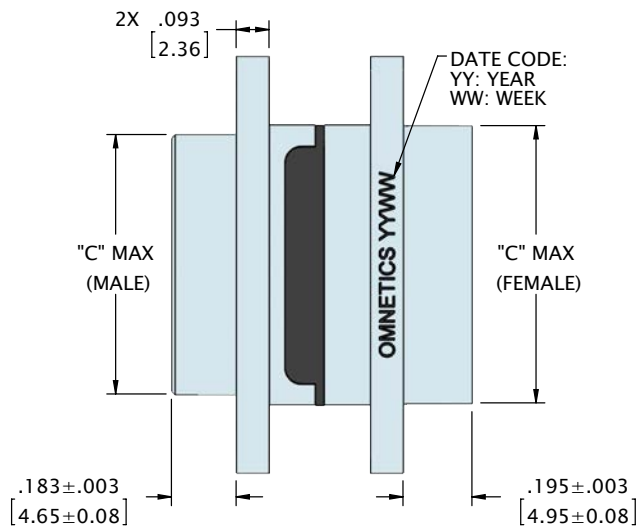
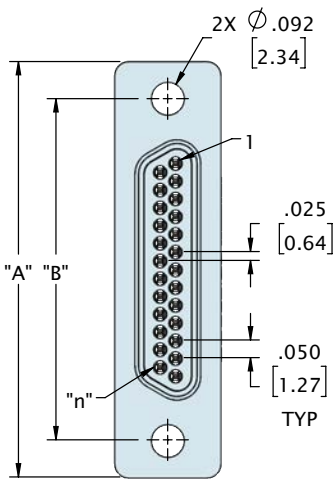
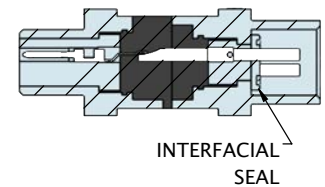
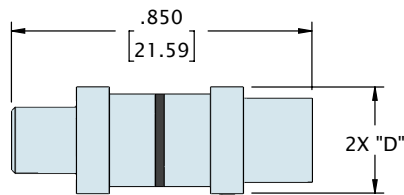

CONTACTS	ROWS	"A"	"B"	"C" (MALE)	"C" (FEMALE)	"D"
9	2	.775 [19.69]	.565 [14.35]	.334 [8.48]	.400 [10.17]	.260 [6.60]
15	2	.925 [23.50]	.715 [18.16]	.484 [12.29]	.550 [13.98]	.260 [6.60]
21	2	1.075 [27.31]	.865 [21.97]	.634 [16.10]	.700 [17.79]	.260 [6.60]
25	2	1.175 [29.85]	.965 [24.51]	.734 [18.64]	.800 [20.33]	.260 [6.60]
31	2	1.325 [33.66]	1.115 [28.32]	.884 [22.45]	.950 [24.14]	.260 [6.60]
37	2	1.475 [37.47]	1.265 [32.13]	1.034 [26.26]	1.100 [27.95]	.260 [6.60]
51	2	1.825 [46.36]	1.615 [41.02]	1.384 [35.15]	1.450 [36.84]	.260 [6.60]
51	3	1.425 [36.20]	1.215 [30.86]	.984 [24.99]	1.050 [26.68]	.300 [7.62]

DIMENSIONS IN [ ] ARE IN MILLIMETERS AND ARE FOR REFERENCE ONLY

# MICRO-D CONNECTOR SAVER (TYPE Z)

## LATCHING MICRO-D CONNECTOR SAVER

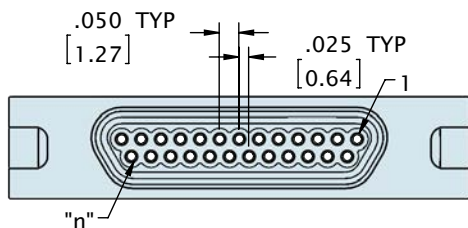
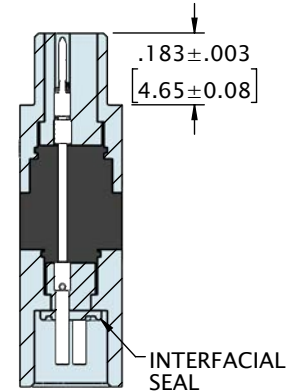
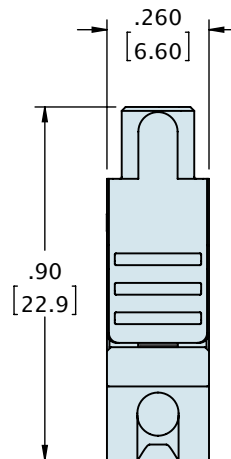
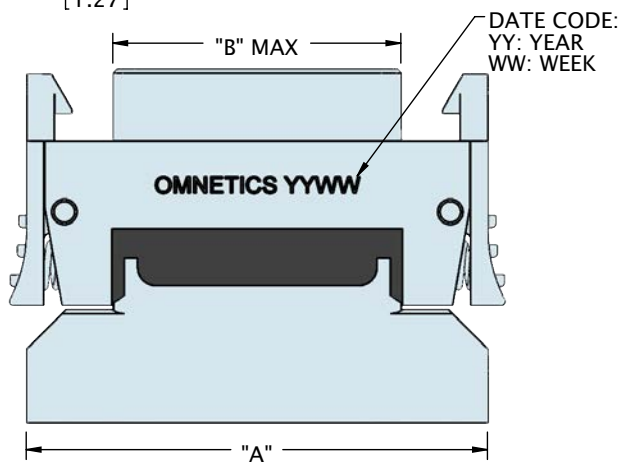
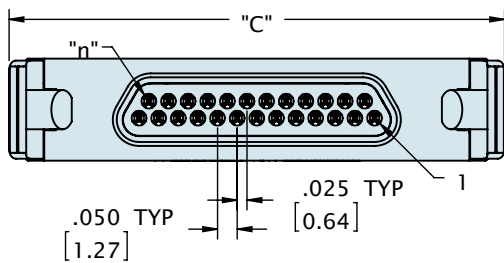

CONTACTS	ROWS	"A"	"B"	"C"
9	2	.775 [19.69]	.334 [8.48]	.09 [2.2]
15	2	.925 [23.50]	.484 [12.29]	1.01 [25.7]
21	2	1.075 [27.31]	.634 [16.10]	1.16 [29.5]
25	2	1.175 [29.85]	.734 [18.64]	1.26 [32.0]
31	2	1.325 [33.66]	.884 [22.45]	1.41 [35.8]
37	2	1.475 [37.47]	1.034 [26.26]	1.56 [39.6]
51	2	1.825 [46.36]	1.384 [35.15]	1.91 [48.5]

DIMENSIONS IN [ ] ARE IN MILLIMETERS AND ARE FOR REFERENCE ONLY



## ORDERING GUIDE

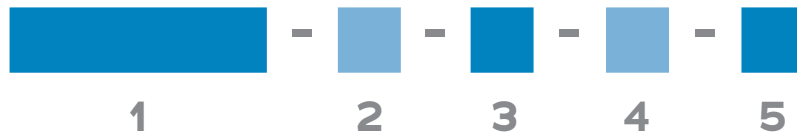

<b>1 Series</b>	<b>MMDZ</b> Dual Row Connector Saver	<b>LMDZ</b> Latching Dual Row Connector Saver
<b>2 Number of Contacts</b>	<b>O09</b> <b>O15</b> <b>O21</b> <b>O25</b> <b>O31</b> <b>O37</b> <b>O51*</b>	
	* Use <b>512</b> for Two Rows <b>O51</b> and <b>513</b> for Three Rows <b>O51</b> ( <b>513</b> is for Dual Row only)	
<b>3 Shell Material &amp; Finish</b>	<b>N</b> Aluminum Shell, Electroless Nickel Plated	<b>CD</b> Aluminium Shell, Cadmium Plated
	<b>B</b> Aluminium Shell, Black Anodized	<b>P</b> Stainless Steel Shell, Passivated
<b>4 Common Options</b>	<b>HT</b> High Temp Epoxy	<b>RH</b> RoHS Compliant
<b>5 Special Instructions</b>	<b>YYY</b> Describe anything that is not covered in standard options	

**HARDWARE OPTION 00**  
- NO HARDWARE

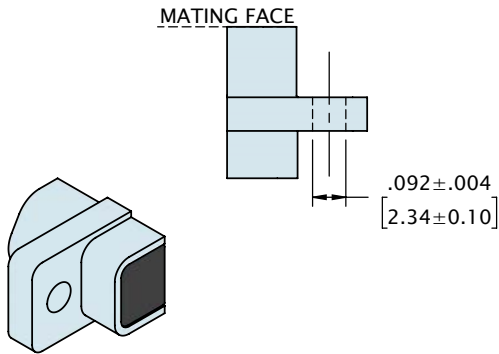

**HARDWARE OPTION 01**  
- FIXED JACKPOST

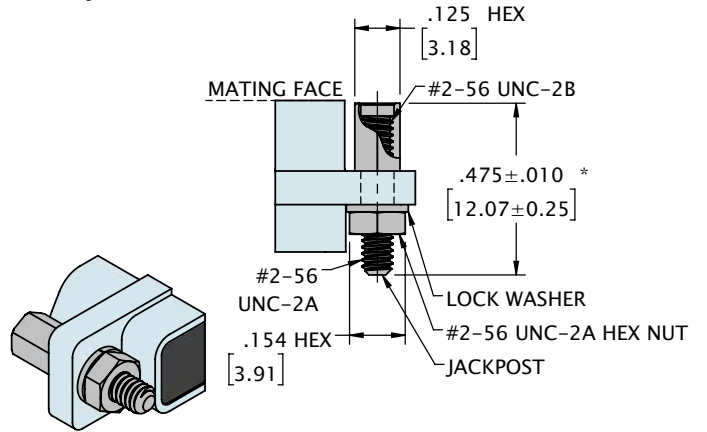

\*FOR ALL TYPES EXCEPT DD AND H2. OVERALL LENGTH FOR STANDARD DD JACKPOST IS .560 [14.22] MAX AND .385 [9.78] MAX FOR H2

**HARDWARE OPTION 02**  
- JACKSCREW, STANDARD LENGTH W/ HEX DRIVE

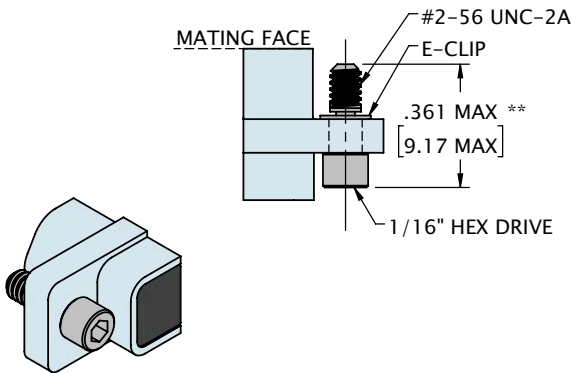

\*\*FOR ALL TYPES EXCEPT HORIZONTAL SURFACE MOUNT (H0) OVERALL LENGTH FOR STANDARD H0 JACKSCREW IS .485 [12.32] MAX.

**HARDWARE OPTION 03**  
- JACKSCREW, STANDARD LENGTH W/ SLOTTED DRIVE

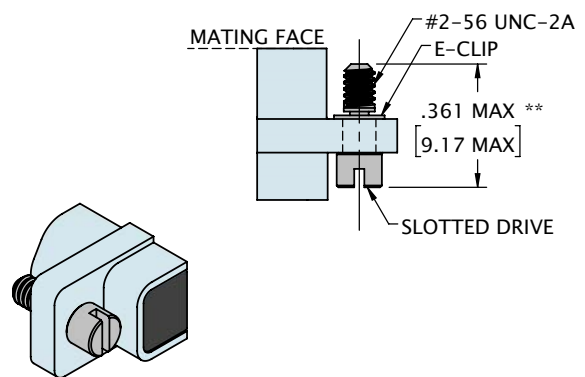

\*\*FOR ALL TYPES EXCEPT HORIZONTAL SURFACE MOUNT (H0) OVERALL LENGTH FOR STANDARD H0 JACKSCREW IS .485 [12.32] MAX.

**HARDWARE OPTION 04**  
- JACKSCREW, LONG LENGTH W/ HEX DRIVE

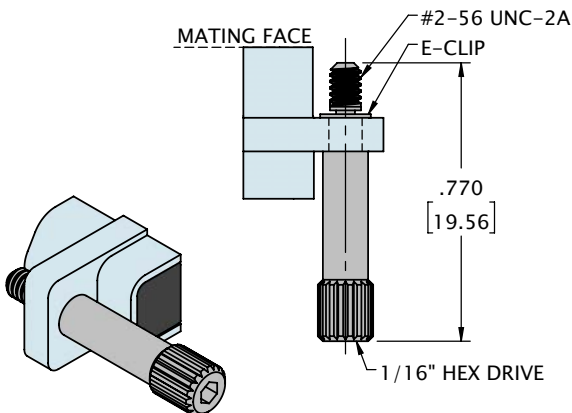

**HARDWARE OPTION 05**  
- JACKSCREW, LONG LENGTH W/ SLOTTED DRIVE

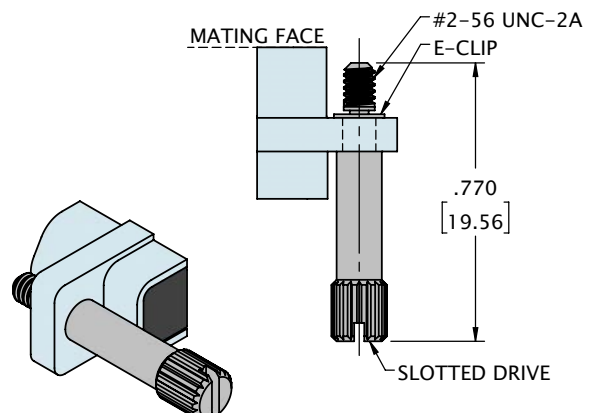

**HARDWARE OPTION 06**  
- FLOAT MOUNT, FRONT MOUNTED

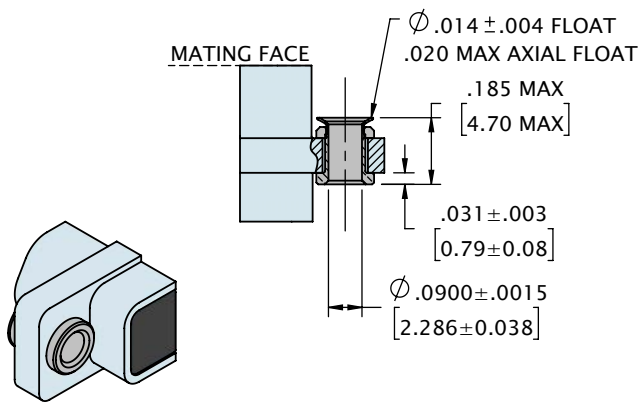

**HARDWARE OPTION 07**  
- FLOAT MOUNT, REAR MOUNTED

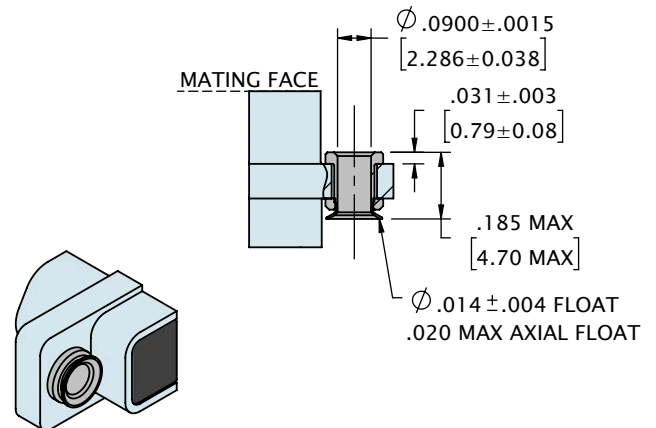

TO ORDER LOOSE HARDWARE SEPARATELY USE OMNETICS PART NUMBERS BELOW

JACKSCREW ASSEMBLY, #2-56,  
STANDARD LENGTH WITH HEX DRIVE

OMNETICS PART #:  
A97007-001

HARDWARE CODE:  
02

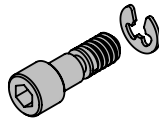

JACKSCREW ASSEMBLY, #2-56,  
STANDARD LENGTH WITH HEX DRIVE  
FOR HORIZONTAL SURFACE MOUNT (H0)

OMNETICS PART #:  
A97007-003

HARDWARE CODE:  
02

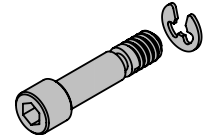

JACKSCREW ASSEMBLY, #2-56,  
STANDARD LENGTH WITH SLOTTED  
DRIVE

OMNETICS PART #:  
A97008-001

HARDWARE CODE:  
03

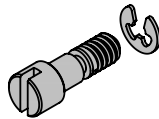

JACKPOST ASSEMBLY, #2-56,  
STANDARD

OMNETICS PART #:  
A97009-001

HARDWARE CODE:  
01

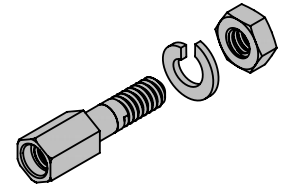

JACKSCREW ASSEMBLY, #2-56, LONG  
LENGTH WITH HEX DRIVE

OMNETICS PART #:  
A97007-002

HARDWARE CODE:  
04

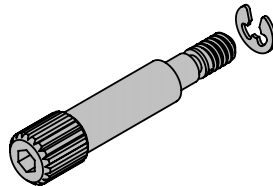

JACKPOST ASSEMBLY, #2-56, EXTENDED  
FOR STRAIGHT THRU-HOLE (DD)

OMNETICS PART #:  
A97009-002

HARDWARE CODE:  
01

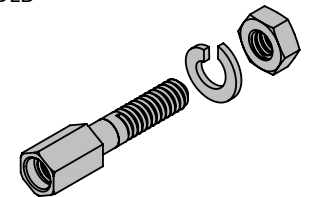

JACKSCREW ASSEMBLY, #2-56, LONG  
LENGTH WITH SLOTTED DRIVE

OMNETICS PART #:  
A97008-002

HARDWARE CODE:  
05

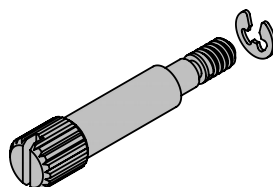

JACKPOST ASSEMBLY, #2-56, SHORT  
FOR RIGHT ANGLE THRU-HOLE (H2)

OMNETICS PART #:  
A97009-003

HARDWARE CODE:  
01

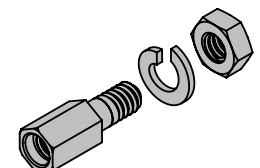

## FRONT PANEL MOUNT HARDWARE

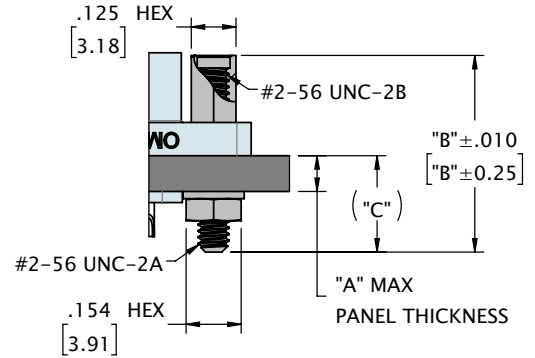
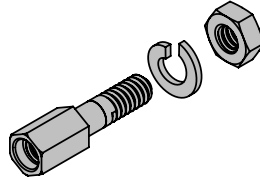
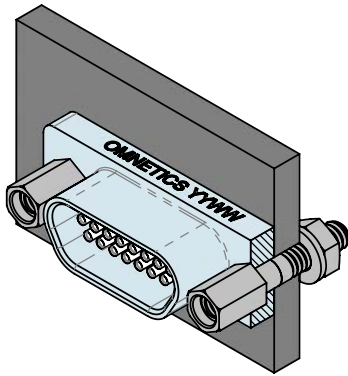

NOTE: EACH KIT INCLUDES TWO (2) JACKPOSTS, WASHERS AND NUTS. FOR USE WITH STANDARD WIRED (WD) OR SOLDERCUP (SS) MICRO-D CONNECTORS.

OMNETICS PART #	"A"	"B"	"C"
A97006-001	.05 [1.3]	.475 [12.07]	.195 [4.95]
A97006-002	.13 [3.3]	.550 [13.97]	.270 [6.86]

DIMENSIONS IN [ ] ARE IN MILLIMETERS AND ARE FOR REFERENCE ONLY

## REAR PANEL MOUNT HARDWARE

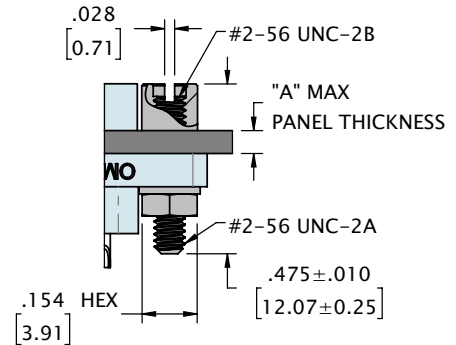
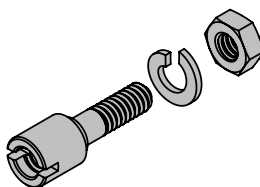
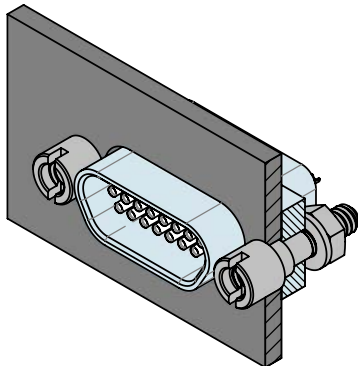

NOTE: EACH KIT INCLUDES TWO (2) JACKPOSTS, WASHERS AND NUTS. FOR USE WITH STANDARD WIRED (WD) OR SOLDERCUP (SS) MICRO-D CONNECTORS.

OMNETICS PART #	MIN	"A"	MAX
A97006-101	.027 [.69]		.033 [.84]
A97006-102	.059 [1.50]		.065 [1.65]
A97006-103	.090 [2.29]		.096 [2.44]

DIMENSIONS IN [ ] ARE IN MILLIMETERS AND ARE FOR REFERENCE ONLY

## LATCHING REAR PANEL MOUNT HARDWARE

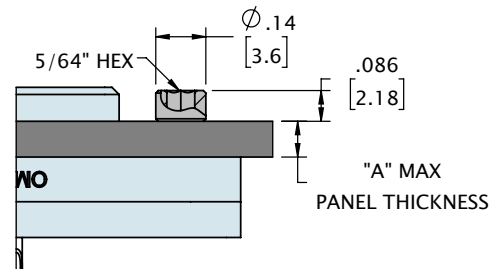
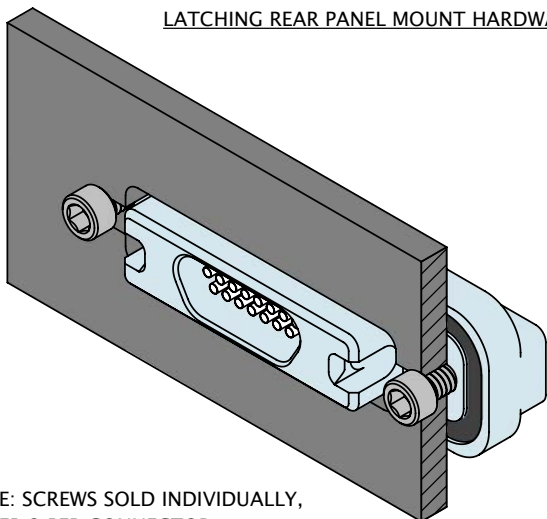

NOTE: SCREWS SOLD INDIVIDUALLY, ORDER 2 PER CONNECTOR

OMNETICS PART #	MIN	"A"	MAX
D6292-156	.010 [.25]		.045 [1.14]
D6292-187	.045 [1.14]		.094 [2.39]

DIMENSIONS IN [ ] ARE IN MILLIMETERS AND ARE FOR REFERENCE ONLY

FRONT PANEL MOUNT CUTOUT

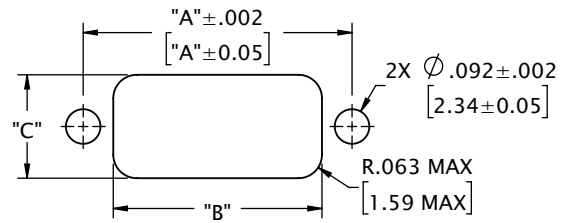
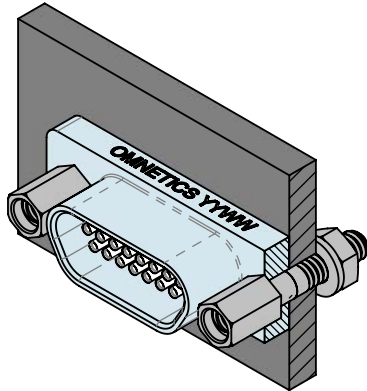

CONTACTS	ROWS	"A"	"B"	"C"
9	2	.565 [14.35]	.405 [10.29]	.275 [6.99]
15	2	.715 [18.16]	.555 [14.10]	.275 [6.99]
21	2	.865 [21.97]	.705 [17.91]	.275 [6.99]
25	2	.965 [24.51]	.805 [20.45]	.275 [6.99]
31	2	1.115 [28.32]	.955 [24.26]	.275 [6.99]
37	2	1.265 [32.13]	1.105 [28.07]	.275 [6.99]
51	2	1.615 [41.02]	1.455 [36.96]	.275 [6.99]
51	3	1.215 [30.86]	1.055 [26.80]	.315 [8.00]

DIMENSIONS IN [ ] ARE IN MILLIMETERS AND ARE FOR REFERENCE ONLY

REAR PANEL MOUNT CUTOUT

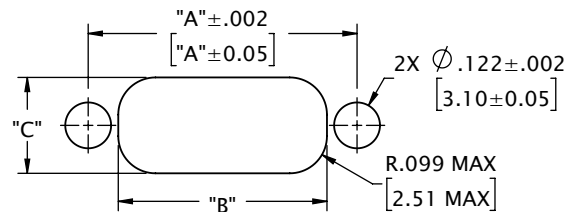
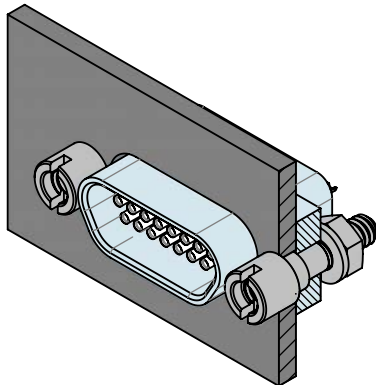

CONTACTS	ROWS	"A"	"B"	"C"
9	2	.565 [14.35]	.405 [10.29]	.255 [6.48]
15	2	.715 [18.16]	.555 [14.10]	.255 [6.48]
21	2	.865 [21.97]	.705 [17.91]	.255 [6.48]
25	2	.965 [24.51]	.805 [20.45]	.255 [6.48]
31	2	1.115 [28.32]	.955 [24.26]	.255 [6.48]
37	2	1.265 [32.13]	1.105 [28.07]	.255 [6.48]
51	2	1.615 [41.02]	1.455 [36.96]	.255 [6.48]
51	3	1.215 [30.86]	1.055 [26.80]	.298 [7.57]

DIMENSIONS IN [ ] ARE IN MILLIMETERS AND ARE FOR REFERENCE ONLY

LATCHING REAR PANEL MOUNT CUTOUT

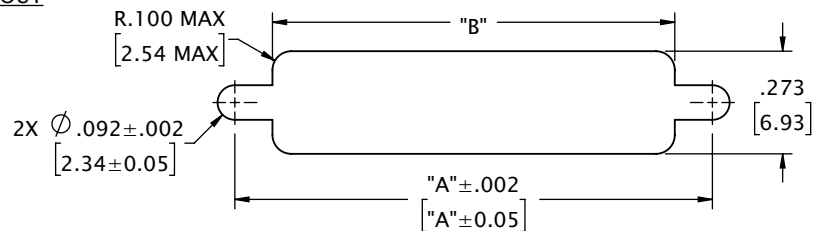
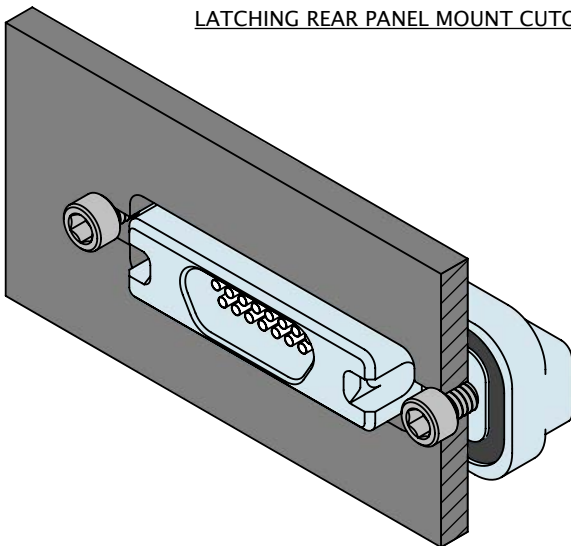

CONTACTS	ROWS	"A"	"B"
9	2	1.120 [28.45]	.920 [23.37]
15	2	1.270 [32.26]	1.070 [27.18]
21	2	1.420 [36.07]	1.220 [30.99]
25	2	1.520 [38.61]	1.320 [33.53]
31	2	1.670 [42.42]	1.470 [37.34]
37	2	1.820 [46.23]	1.620 [41.15]
51	2	2.170 [55.12]	1.970 [50.04]

DIMENSIONS IN [ ] ARE IN MILLIMETERS AND ARE FOR REFERENCE ONLY

# HARDWARE & MISC

MICRO-D BACKSHELL  
45 DEGREE ROUND ENTRY

OMNETICS PART #:  
A97000-XXX

OPTION CODE:  
BS1

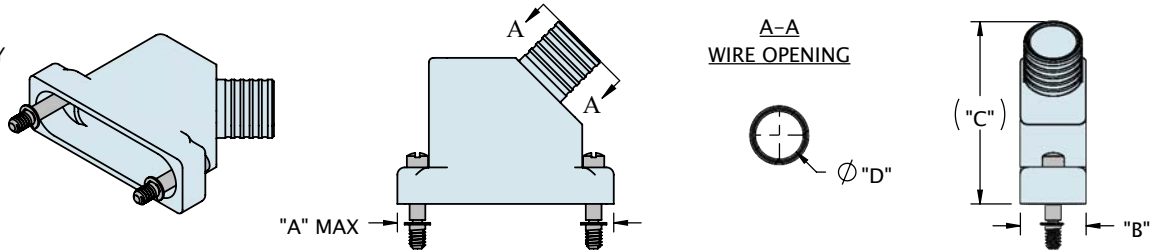

CONTACTS	ROWS	"A"	"B"	"C"	"D"
009	2	.785 [19.94]	.340 [8.64]	.848 [21.54]	.160 [4.06]
015	2	.935 [23.75]	.340 [8.64]	.898 [22.81]	.190 [4.83]
021	2	1.085 [27.56]	.340 [8.64]	.948 [24.08]	.220 [5.59]
025	2	1.185 [30.10]	.360 [9.14]	.998 [25.35]	.260 [6.60]
031	2	1.335 [33.91]	.360 [9.14]	1.038 [26.37]	.275 [6.99]
037	2	1.485 [37.72]	.360 [9.14]	1.078 [27.38]	.285 [7.24]
051	2	1.835 [46.61]	.413 [10.49]	1.078 [27.38]	.350 [8.89]
051	3	1.435 [36.45]	.413 [10.49]	1.160 [29.46]	.350 [8.89]
069	3	1.735 [44.07]	.473 [12.01]	1.160 [29.46]	.410 [10.41]

DIMENSIONS IN [ ] ARE IN MILLIMETERS AND ARE FOR REFERENCE ONLY

MICRO-D BACKSHELL  
STRAIGHT OVAL ENTRY

OMNETICS PART #:  
A97001-XXX

OPTION CODE:  
BS2

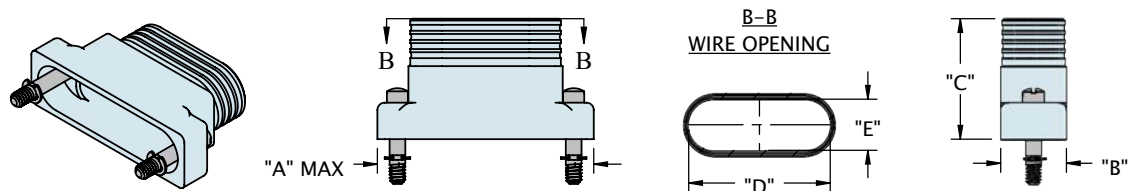

CONTACTS	ROWS	"A"	"B"	"C"	"D"	"E"
009	2	.785 [19.94]	.340 [8.64]	.66 [16.8]	.375 [9.53]	.280 [7.11]
015	2	.935 [23.75]	.340 [8.64]	.66 [16.8]	.525 [13.34]	.280 [7.11]
021	2	1.085 [27.56]	.340 [8.64]	.66 [16.8]	.675 [17.15]	.280 [7.11]
025	2	1.185 [30.10]	.360 [9.14]	.66 [16.8]	.775 [19.69]	.280 [7.11]
031	2	1.335 [33.91]	.360 [9.14]	.66 [16.8]	.925 [23.50]	.280 [7.11]
037	2	1.485 [37.72]	.360 [9.14]	.66 [16.8]	1.075 [27.31]	.280 [7.11]
051	2	1.835 [46.61]	.360 [9.14]	.66 [16.8]	1.425 [36.20]	.280 [7.11]
051	3	1.435 [36.45]	.380 [9.65]	.88 [22.4]	1.025 [26.04]	.320 [8.13]
069	3	1.735 [44.07]	.380 [9.65]	.88 [22.4]	1.325 [33.66]	.320 [8.13]
100	4	2.170 [55.12]	.423 [10.74]	.88 [22.4]	1.480 [37.59]	.363 [9.22]

DIMENSIONS IN [ ] ARE IN MILLIMETERS AND ARE FOR REFERENCE ONLY

MICRO-D BACKSHELL  
90 DEGREE OVAL ENTRY

OMNETICS PART #:  
A97002-XXX

OPTION CODE:  
BS3

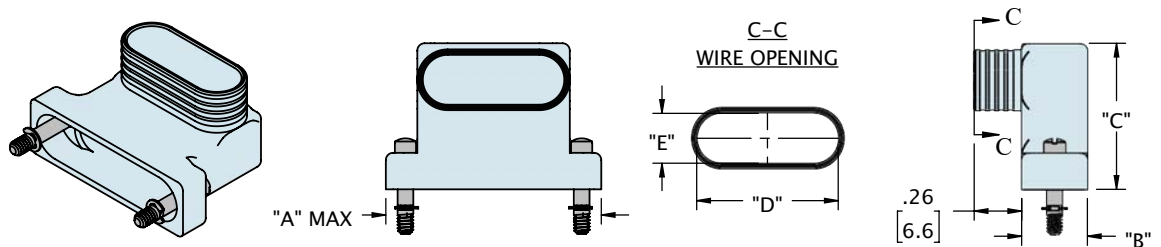

CONTACTS	ROWS	"A"	"B"	"C"	"D"	"E"
009	2	.785 [19.94]	.340 [8.64]	.80 [20.3]	.375 [9.53]	.273 [6.93]
015	2	.935 [23.75]	.340 [8.64]	.80 [20.3]	.525 [13.34]	.273 [6.93]
021	2	1.085 [27.56]	.340 [8.64]	.80 [20.3]	.675 [17.15]	.273 [6.93]
025	2	1.185 [30.10]	.360 [9.14]	.80 [20.3]	.775 [19.69]	.273 [6.93]
031	2	1.335 [33.91]	.360 [9.14]	.80 [20.3]	.925 [23.50]	.273 [6.93]
037	2	1.485 [37.72]	.360 [9.14]	.80 [20.3]	1.075 [27.31]	.273 [6.93]
051	2	1.835 [46.61]	.360 [9.14]	.80 [20.3]	1.425 [36.20]	.273 [6.93]
051	3	1.435 [36.45]	.400 [10.16]	1.00 [25.4]	1.025 [26.04]	.313 [7.95]
069	3	1.735 [44.07]	.400 [10.16]	1.00 [25.4]	1.325 [33.66]	.313 [7.95]

DIMENSIONS IN [ ] ARE IN MILLIMETERS AND ARE FOR REFERENCE ONLY

**MICRO-D BACKSHELL  
45 DEGREE ELLIPTICAL ENTRY**

OMNETICS PART #:  
A97003-XXX

OPTION CODE:  
BS4

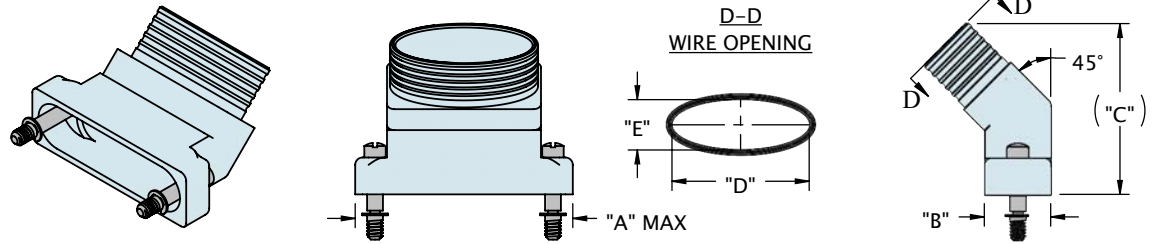

CONTACTS	ROWS	"A"	"B"	"C"	"D"	"E"
009	2	.780 [19.81]	.340 [8.64]	.834 [21.18]	.344 [8.74]	.273 [6.93]
015	2	.930 [23.62]	.340 [8.64]	.859 [21.82]	.494 [12.55]	.273 [6.93]
021	2	1.080 [27.43]	.340 [8.64]	.884 [22.45]	.644 [16.36]	.273 [6.93]
025	2	1.180 [29.97]	.360 [9.14]	.926 [23.52]	.744 [18.90]	.273 [6.93]
031	2	1.330 [33.78]	.360 [9.14]	.946 [24.03]	.894 [22.71]	.273 [6.93]
037	2	1.480 [37.59]	.360 [9.14]	.986 [25.04]	1.044 [26.52]	.273 [6.93]
051	2	1.830 [46.48]	.360 [9.14]	1.043 [26.49]	1.394 [35.41]	.273 [6.93]
051	3	1.430 [36.32]	.400 [10.16]	1.041 [26.44]	.994 [25.25]	.313 [7.95]
069	3	1.730 [43.94]	.400 [10.16]	1.048 [26.62]	1.294 [32.87]	.313 [7.95]

DIMENSIONS IN [ ] ARE IN MILLIMETERS AND ARE FOR REFERENCE ONLY

**MICRO-D BACKSHELL SPLIT  
STRAIGHT ELLIPTICAL ENTRY**

OMNETICS PART #:  
A97004-XXX

OPTION CODE:  
BS5

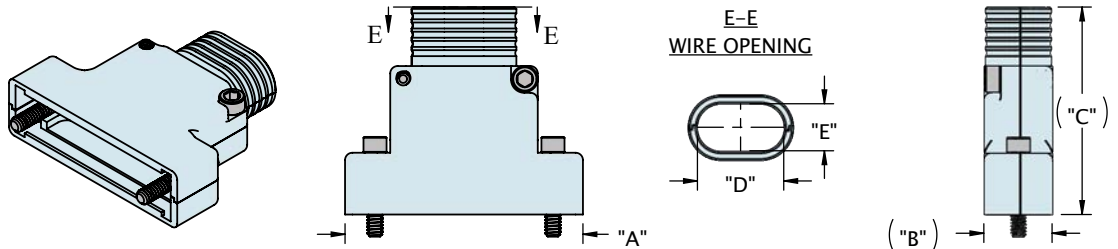

CONTACTS	ROWS	"A"	"B"	"C"	"D"	"E"
015	2	1.040 [26.42]	.370 [9.40]	1.075 [27.31]	.175 [4.45]	.255 [6.48]
021	2	1.190 [30.23]	.370 [9.40]	1.075 [27.31]	.368 [9.35]	.255 [6.48]
025	2	1.290 [32.77]	.370 [9.40]	1.125 [28.58]	.468 [11.89]	.255 [6.48]
031	2	1.440 [36.58]	.370 [9.40]	1.165 [29.59]	.618 [15.70]	.255 [6.48]
037	2	1.590 [40.39]	.370 [9.40]	1.205 [30.61]	.768 [19.51]	.255 [6.48]
051	2	1.940 [49.28]	.370 [9.40]	1.285 [32.64]	1.118 [28.40]	.255 [6.48]
051	3	1.540 [39.12]	.410 [10.41]	1.285 [32.64]	.718 [18.24]	.295 [7.49]
069	3	1.840 [46.74]	.410 [10.41]	1.600 [40.64]	1.018 [25.86]	.295 [7.49]
100	4	2.275 [57.79]	.453 [11.51]	1.351 [34.32]	1.238 [31.45]	.338 [8.59]

DIMENSIONS IN [ ] ARE IN MILLIMETERS AND ARE FOR REFERENCE ONLY

**MICRO-D BACKSHELL SPLIT  
45 DEGREE ROUND ENTRY**

OMNETICS PART #:  
A97005-XXX

OPTION CODE:  
BS6

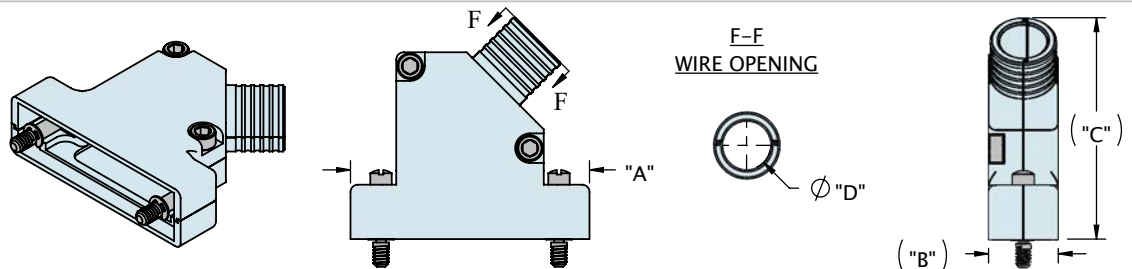

CONTACTS	ROWS	"A"	"B"	"C"	"D"
009	2	.896 [22.76]	.38 [9.7]	1.050 [26.67]	.160 [4.06]
015	2	1.046 [26.57]	.38 [9.7]	1.100 [27.94]	.190 [4.83]
021	2	1.196 [30.38]	.38 [9.7]	1.150 [29.21]	.220 [5.59]
025	2	1.296 [32.92]	.38 [9.7]	1.200 [30.48]	.260 [6.60]
031	2	1.446 [36.73]	.38 [9.7]	1.240 [31.50]	.275 [6.99]
037	2	1.596 [40.54]	.40 [10.2]	1.280 [32.51]	.285 [7.24]
051	2	1.946 [49.43]	.46 [11.7]	1.280 [32.51]	.350 [8.89]
051	3	1.546 [39.27]	.46 [11.7]	1.362 [34.59]	.350 [8.89]
100	4	2.281 [57.94]	.60 [15.2]	1.425 [36.20]	.490 [12.45]

DIMENSIONS IN [ ] ARE IN MILLIMETERS AND ARE FOR REFERENCE ONLY







### SPACE

Missile Warning  
SATCOM  
PNT Signals  
ISR



### COMMAND

GPS Guided Artillery  
IR Guided Missiles  
High Power Microwaves



### AIR

IO Broadcast  
Radar EA  
IFF Signals



### WATER

Radar Guided Missiles  
RF Sensors  
Laser Comms



### LAND

Tracking Radars  
Laser Dazzler  
Laser Guided Munition

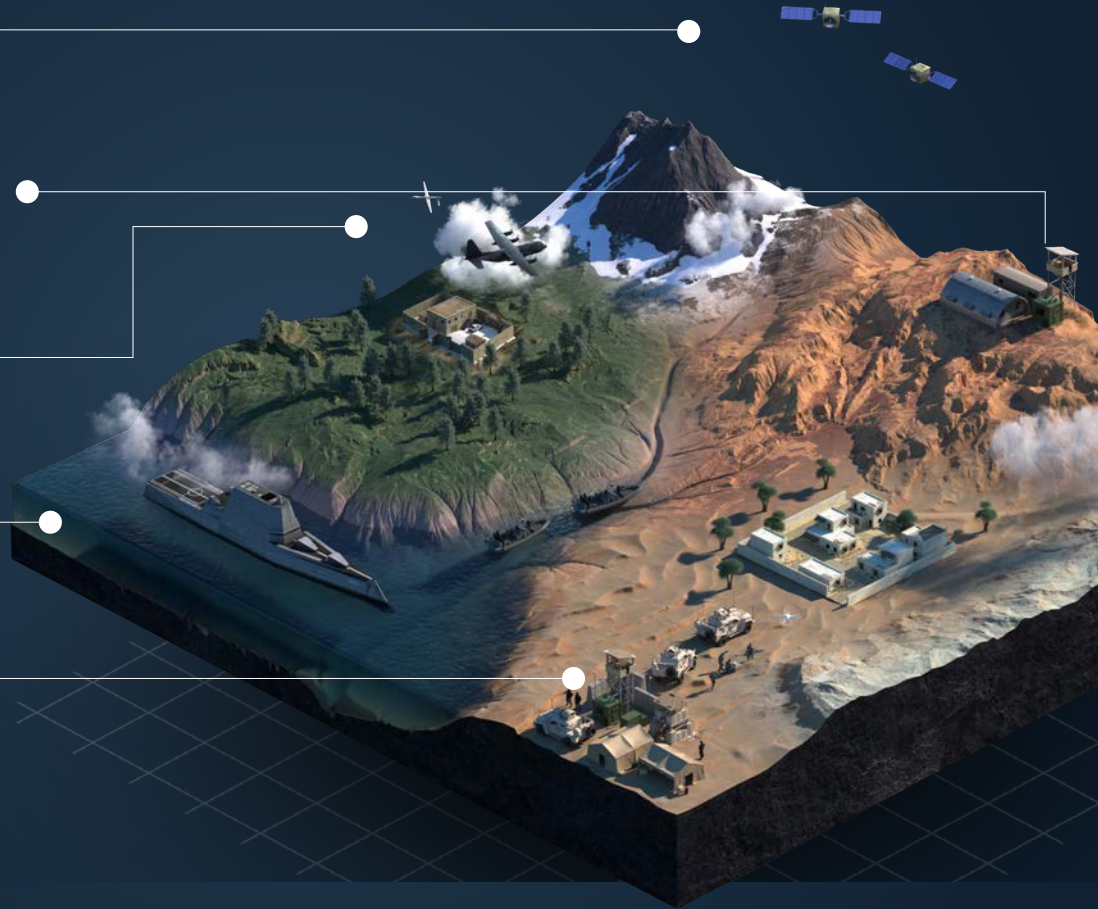

LATCHING  
MICRO - D



LOW PROFILE  
MICRO-D



SINGLE ROW  
MICRO-D



STANDARD  
MICRO-D

## Ruggedize micro-miniature interconnect solutions for high reliability applications.

Omnetics' connectors are proven to deliver exceptional performance in extreme environments for mission-critical applications.

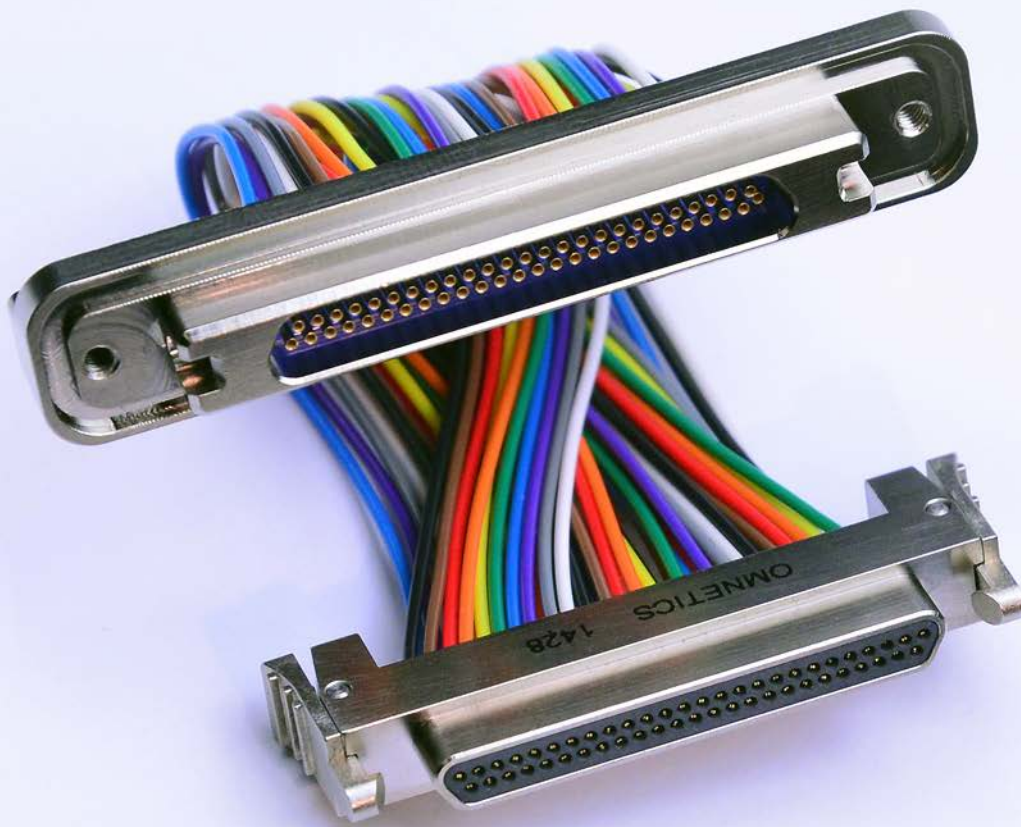



# KENSINGTON

ELECTRONICS inc.

*Not just products - Solutions!*

INTERNATIONAL,  
ALASKA & HAWAII

Please contact one  
of the ISRs.

**Courtney Darrah**

Inside Sales Representative  
cdarrah@keiconn.com  
512-339-3324

**Erin Gagne**

Inside Sales Representative  
egagne@keiconn.com  
512-339-3331

**Kevin Kientopf**

Inside Sales Representative  
kkientopf@keiconn.com  
512-339-3315

**Gabby Bozeman**

Inside Sales Representative  
gbozeman@keiconn.com  
512-339-3325

**John Davis**

Inside Sales Representative  
jdavis@keiconn.com  
512-339-3311

## North American Sales Support Coverage



**Erin Gagne**

Inside Sales Representative  
egagne@keiconn.com  
512-339-3331

**Courtney Darrah**

Inside Sales Representative  
cdarrah@keiconn.com  
512-339-3324

**John Davis**

Inside Sales Representative  
jdavis@keiconn.com  
512-339-3311

**Gabby Bozeman**

Inside Sales Representative  
gbozeman@keiconn.com  
512-339-3325

**Kevin Kientopf**

Inside Sales Representative  
kkientopf@keiconn.com  
512-339-3315

**Scott Kirchmeier**

Regional Sales Manager  
sales@keiconn.com  
619-247-0736 (M)  
512-339-3312 (O)