

Technology to Inspire Innovation

JAE

Connector Selection Guide

2018 – 2019

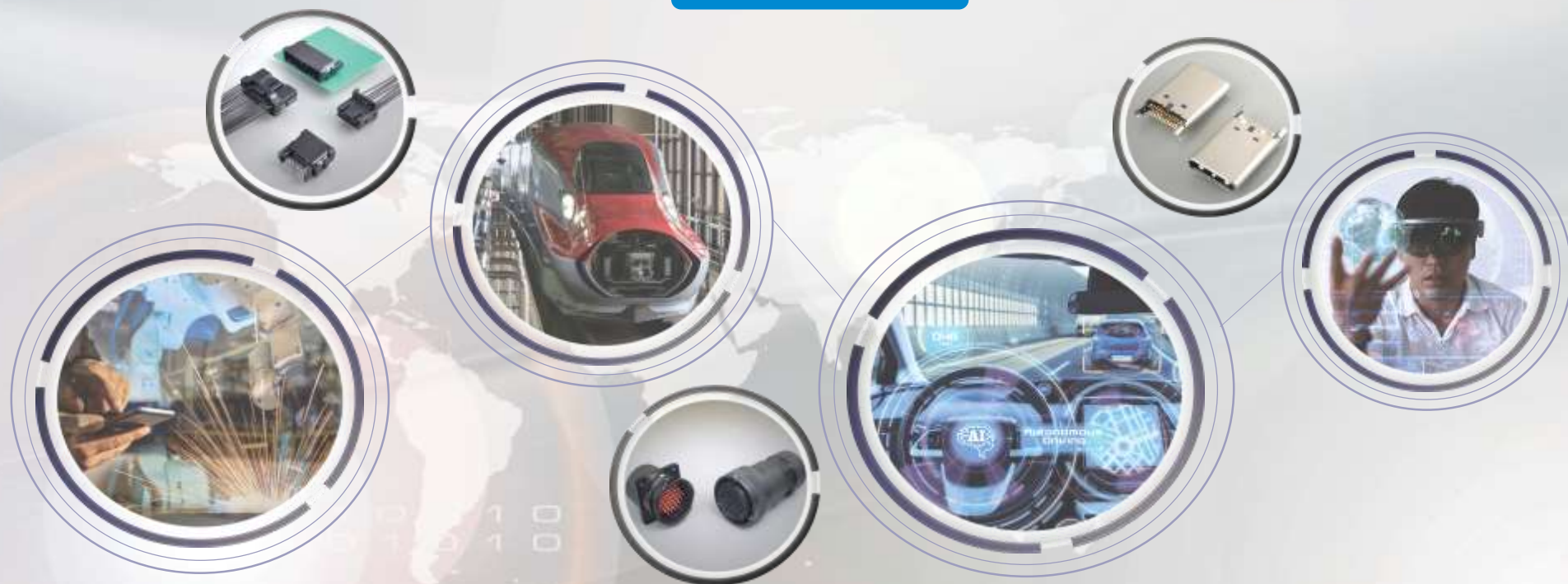

Table of Contents

Company Profile	p. 2
Board-to-Board Connectors	p. 3-6
Board-to-FPC Connectors	p. 7-8
Commercial I/O Connectors	p. 9-10
Industrial I/O Connectors (Rectangular).....	p. 11-12
Industrial I/O Connectors (Circular).....	p. 13-16
Board-to-Cable Connectors	p. 17-18
Card Connectors 1 (microSD, CF, DIMM, PCIe, M.2, MXM 3.0)	p. 19-20
Card Connectors 2 (SIM, Micro SIM, Nano SIM)	p. 21-22
LED Lighting Connectors	p. 23-24
High Power Connectors	p. 25-26
Transportation Connectors	p. 27-32
Contact Information	p. 33-34

View all JAE connectors at www.JAE.com

Contact your JAE representative to request the electronic version of this connector guide.



About JAE

In 1953, Japan Aviation Electronics Industry, Ltd. began with the ambition of becoming a leading manufacturer in the aviation and space industries in Japan. Since then, we were able to expand and also specialize in designing and manufacturing connectors and gyroscopes.

Always keeping our corporate philosophy **“Explore, Create, and Practice”** in mind, we were able to successfully establish 3 strong product lines:

- Connectors
- User Interface Solutions
- Aerospace



JAE strives to be the number one partner for global customers by staying innovative and creative in an industry where technology is continuously evolving and advancing.

JAE Electronics, Inc., a subsidiary of parent company JAE, designs, manufactures and markets electronic components, fiber optic connectors, LCD monitor connectors, waterproof electrical connectors, connectors for commercial energy storage systems, and other digital systems. A global company, JAE is a recognized leader in providing solutions to complex design requirements. By combining divergent technologies from experience gained in the aerospace industry, JAE has been able to transfer these technologies into advanced connector designs. From connectors on Japan's Bullet Train, to the smallest hand-held video camera, JAE continues to meet the most demanding applications in the industry.

Technology to Inspire Innovation



Board-to-Board Connectors (1/2)

Series	WP21	WP25D	WP26	WP27D	WP6C	WP7	WP9	WP10
Photo								
Pitch	0.35mm	0.35mm	0.35mm	0.35mm	0.4mm	0.4mm	0.4mm	0.4mm
Stacking Heights	0.6mm	0.7mm	0.6mm	0.7mm	0.8mm	0.7mm	0.8mm	0.7mm
Pin Count	10,20,24,30,34,40,42,46,54	10,28,38 (+2 power pins)	10,24,34,40,42,54,60	10,24,30,34,38,40,50 (+2 power pins)	24,30	10,16,20,24,26,28,30,32,34,40,50,60,70	10,14,20,24,30,32,40,60	2,4 (+4 power pins)
High Power Contacts	N/A	2	N/A	2	N/A	N/A	N/A	4
Board Mount	SMT	SMT	SMT	SMT	SMT	SMT	SMT	SMT
Current Rating	0.3A	0.3A Signal 3A Power	0.3A	0.3A Signal 3A Power	0.3A	0.3A	0.3A	0.4A Signal 5A Power
Voltage Rating	50V AC/DC	50V AC/DC	50V AC/DC	50V AC/DC	50V AC/DC	50V AC/DC	50V AC/DC	50V AC/DC
Durability	30 cycles	30 cycles	30 cycles	30 cycles	30 cycles	30 cycles	50 cycles	30 cycles
Features	Smallest footprint and lowest height	Hybrid connector w/ signal pins +2 high power contacts.	Small size and metal reinforcement in mating area to reduce risk of damage to insulator during mating.	Hybrid connector with high power contacts as well as metal reinforcement in mating area to reduce risk of damage to insulator.	Shielded connector for improved grounding and EMI/EMC performance.	High retention force for low pin counts and low insertion force for high pin counts.	Small connector width helps reduce board mounting space.	High power connector ideal for connecting batteries.

Socket side: **WP10-S###VA10-R15000**
Pin side: **WP10-P###VA10-R15000**

Orderable in Reels of 15,000

Socket side: **WP6C - S###VA1 - R6000**
Pin side: **WP6C - P###VA1 - R6000**

**Shielded version*

Orderable in Reels of 6,000

Socket side: **WP9 - S###VA1 - R6000**
Pin side: **WP9 - P###VA1 - R6000**

Orderable in Reels of 6,000

Socket side: **WP21-S###VA1-R8000**
Pin side: **WP21-P###VA1-R8000**

Orderable in Reels of 8,000

For pin counts up to 32:

Socket side: **WP7A - S###VA1 - R8000**
Pin side: **WP7 - P###VA1 - R8000**

For pin counts above 32:

Socket side: **WP7B - S###VA1 - R8000**
Pin side: **WP7B - P###VA1 - R8000**

Orderable in Reels of 6,000

Socket side: **WP26 - S###VA1 - R15000**
Pin side: **WP26 - P###VA1 - R15000**

Orderable in Reels of 15,000

Socket side: **WP25D-S###VA1-R8000**
Pin side: **WP25D-P###VA1-R8000**

Orderable in Reels of 8,000

Socket side: **WP27D - S###VA3 - R15000**
Pin side: **WP27D - P###VA3 - R15000**

Orderable in Reels of 15,000

Board-to-Board Connectors (2/2)

Series	WR	KX14/15	KX24/25	TX24/25	TX24A/25A
Photo					
Pitch	0.5mm	0.8mm	0.8mm	1.27mm	1.27mm
Stacking Heights	4.0, 4.5, 5.0, 5.5, 6.0, 6.5, 7.0, 8.0, 9.0mm	4.0, 5.0, 6.0, 7.0, 8.0, 9.0, 10.0, 11.0, 12.0mm	N/A	12.0-24.0mm (±2.0mm)	9mm
Pin Count (Parallel)	20,30,40,50, 60,70,80,100,120,160	20,30,40,50,60,70,80	80,100,120, 140,180 (coplanar)	30,40,50,60,80,100, 120	N/A
Pin Count (Right Angle)	30,40,50,60,70,80,120	20,30,40,50, 60,70,80	80,100,120,140,180	30,40,50,60,80,100, 120,140	80
Board Mount	SMT	SMT	Thru-hole	Thru-hole	Thru-hole
Current Rating	0.3A	0.5A	0.5A	1.0A	1.0A
Voltage Rating	200VAC 300VDC	200VAC 300VDC	200VAC	250VAC	250VAC
Durability	500 cycles	500 cycles	500 cycles	500 cycles	500 cycles
Features	9 different vertical stack heights.	Mating guide and key to prevent mis-mating.	Robust mating guide. Click response when mated.	Ribbon type contacts ensure reliable electrical continuity.	Ribbon type contacts ensure reliable electrical continuity. Improved electrical characteristics from TX24/25 Series, supporting higher-speed transmission.

Board-to-FPC Connectors

Series	FF08	FR02	FB10	FA10	FF03	FA5B	FA5S	FM8
Photo								
Pitch	0.2mm	0.2mm	0.3mm	0.5mm	0.5mm	0.5mm	0.5mm	0.5mm
Mounted Height	0.9mm	0.82mm	0.9mm	0.9mm	2mm	1.0mm	1.45mm	2.2mm
FPC/FFC Thickness	0.15 ± 0.02mm	0.2 ± 0.03mm	0.2 ± 0.03mm	0.2 ± 0.03mm	0.3 ± 0.05mm	0.3 ± 0.05mm	0.3 ± 0.05mm	0.3mm ± 0.03mm
FPC Contact Orientation	Lower	Upper or Lower	Lower	Upper or Lower	Lower	Lower	Lower	Lower
Pin Count	25,29,41,51,71,81	23,41,51,61	11,13,15,19,21,25,27,31,33,41,45,51,61	4,5,6,10	60,64,68,80,96	6,8,10,16,20,30,36,40,45,50	6,8,10,15,16,18,20,22,24,26,30,36,40,45,50	41,51,60
Current Rating	0.3A	0.25A	0.35A	0.5A	0.5A	0.8A	0.8A	0.5A
Voltage Rating	50V	50V	50V	50V	50V	50V	50V	50V
Features	Smallest pitch. Rotating actuator.	Lowest profile in class. Robust rear actuator.	Smallest PCB footprint. Easy actuator operation with tactile lock feedback.	Quick one-step insertion & removal. Requires no actuator operation.	Highest pin count.	Mid mount type for low profile applications.	Easy slider operation.	Compatible with high speed signal transmission. Guides hold the FFC in place to prevent misalignment.

Loose pcs: **FA5B0##HP1**

Reel: **FA5B0##HP1 R3000**

- 1: Standard
- 2: Larger hold downs

Loose pcs: **FA5S0##HP1**

Reel: **FA5S0##HP1R3000**

Reel: **FA10##SA1-R8000**

Reel: **FB10S###JT1R6000**

Reel: **FR02C0##JA1-R5000**

Loose pcs: **FF03##SA1**

Reel: **FF03##SA1 - R2000**

Reel: **FF08##SA1-R3000**

Reel: **FM8S###HA2R4000**

Commercial I/O Connectors

Series	DC2	DC3	DD1	DD2	DX07	DP3	DX4	DC1
Photo								
Pitch	0.4mm	0.4mm	0.5mm	0.5mm	0.5mm	0.6mm	0.65mm	1.0mm
Interface Type	Cable I/O	Cable I/O	Cable I/O R/A Dock 75° Vert Dock	Cable I/O R/A Dock Vert Dock	Cable I/O	Cable I/O	Cable I/O	Cable I/O
Pin Count (Parallel)	19	19	30	40	24	20	5	19
Signal Standard	HDMI	HDMI	USB 2.0	USB 2.0	USB Type-C™ USB 3.1 Thunderbolt™ 3*	Thunderbolt™ 1 & 2	USB 2.0	HDMI
Current Rating	0.5A	0.3A	Signal:0.5A Power: 1.0A	Signal:0.5A Power: 1.0A	Vbus / GND: 5A Vconn: 1.25A Signal: 0.25A	Power: 1.5A	Signal: 0.5A Power: 1.8A	0.5A
Voltage Rating	40VAC	40VAC	30VAC	30VAC	20VAC	40VAC	30VAC	40VAC
Durability	5,000 cycles	5,000 cycles	10,000 cycles	10,000 cycles	10,000 cycles	10,000 cycles	10,000 cycles	10,000 cycles
Operating Temp	-20 ~ +85°C	-20 ~ +85°C	-25 ~ +75°C	-25 ~ +75°C	-30 ~ +80°C	-20 ~ +85°C	-30 ~ +80°C	-20 ~ +85°C
Locking	Friction	Friction	Latch	Latch	Friction	Friction	Friction	Friction
Features	Mini HDMI Type-C compatible. Requires HDMI adopter status.	Micro HDMI Type-D compatible. Requires HDMI adopter status.	Docking connector to combine various high speed signals in a single connector.	Robust and compact design. Compatible with high speed signaling.	Reversible plug for easier insertion. Multiple receptacle mounting options available.	Thunderbolt™ compatible. Various board mounting options available.	Micro USB 2.0 standard compatible. Various mounting options available.	HDMI Type A compatible. Requires HDMI adopter status.

*Select part numbers only. Contact us for more information.

Receptacle: **DC1RS19JA7**

Cable Harness: **DC1P019ST30200B**

Restricted to HDMI Adapters
Contact JAE for additional options

Receptacle: **DD1R030HA1** Standard mount
DD1R030JA7 Reverse mount

Docking Plug: **DD1B030VA1** Vertical
DD1B030HA1 Right angle

Cable Plug: **DD1P030MA1**

Receptacle: **DP3R020S U32JQ 1 R400**

Board Mount Type
S: Standard
R: Reverse

T/H lead length
Blank: 1.4mm
1: 2.1mm

Height modification code
U32: 3.2mm up
L05: 0.5mm down

Receptacle: **DC2R019JA4**
Hold Down Type: J: T/H, H: SMT
Modification code

Cable Harness: **DC1DC2ST2150B**

Restricted to HDMI Adapters
Contact JAE for additional options

Receptacle: **DD2R040HP2**

Docking Plug: **DD2B040VP4** Vertical
DD2B040HA2 Right angle

Cable Plug: **DD2P040MA1**

Receptacle: **DX07B024JJ1**

Board Mount Type
B: Mid-mount
S: On-board

J: Horizontal SMT
X: Horizontal Hybrid
W: Vertical SMT

Modification Code

Receptacle: **DC3RX19JA2**
Top Mount

Modification Code

Hold Down Type
X, J: T/H
0, H: SMT

Receptacle: **DX4R005 J J 2**

Modification Code

Hold Down Type
J: T/H
H: SMT

Plug: **DX07P024AJ5** (slim plug)

Cable Harness: **DX07 5 18 S ** N *******

Series

Modification Code
5: Plug

Cable Spec (1)
18: USB3.1 C to C
19: USB3.1 C to A







Cable Overmold/Jacket
S: Black (PVC)
B: Black (TPE)

Modification Code

Cable Spec (2)
K : Gen1 3A
L : Gen 2 3A
N : Gen2 5A

Cable Length
10: 1 meter
20: 2 meter

Industrial I/O Connectors [Rectangular]

Series	DZ02	DF02	JN6	JN14	HB01	HB03	KN01
Photo							
Pitch	0.635mm	1.27mm	3mm	3.2mm	N/A	N/A	N/A
I/O	Cable I/O	Cable I/O	Cable I/O	Cable I/O	Cable I/O	Cable I/O	Cable I/O
Pin Count	8	14, 20, 26, 36, 50 68 (plug only)	2, 4, 7	2, 4, 9	6 (4 power, 2 signal)	2, 4, 8	12, 18, 50/insulator block 6 x insulator block /unit
Current Rating	0.5A	0.5A	(2pos.): 1A (per pos.) (4pos.): 7A (per pos.) (7pos.): 1A (per pos.)	(2pos.): 1A (per pos.) (4pos.): 7A (per pos.) (9pos.): 1A (per pos.)	Power Signal 18 AWG: 9A 24 AWG: 2A 16 AWG: 11A 22 AWG: 3A 14 AWG: 13A 20 AWG: 4A	28 ~ 30 AWG : 1A 24 ~ 26 AWG : 2A	12 AWG x 12 pos.: 23A 16 AWG x 14 pos.: 16A 20 AWG x 18 pos.: 3A 22 AWG x 50 pos.: 1A
Voltage Rating	30VAC	250VAC	(2pos.): 100VAC (4pos.): 200VAC (7pos.): 100VAC	(2pos.): 100VAC (4pos.): 220VAC (9pos.): 100VAC	250VAC	250VAC	12 AWG: 250 VAC 16 AWG: 250 VAC 20 AWG: 24 VDC 22 AWG: 24 VDC
Durability	1,500 cycles	500 cycles	100 cycles	100 cycles	30 cycles	100 cycles	100 cycles
Operating Temp	-40°C ~ +85 °C	-20°C ~ +80 °C	-40°C ~ +125 °C	-40°C ~ +125 °C	-25°C ~ +85 °C	-25°C ~ +105 °C	-25°C ~ +85 °C
Termination	N/A	IDC/Solder	Crimp	Crimp	Crimp	Crimp	Crimp
Locking	Friction	One-touch, screw	Screw	Screw	Friction	Latch Lock	Lever
Features	Vibration-resistant strong lock, ideal for harsh conditions. Compact I/O compatible with IEC/EN 61800-5-2	Half-pitch (1.27mm) interface compatible. Ni-plated plastic hood for lighter weight with EMI shielding.	Plastic, waterproof connector ideal for small servo motors. Mating secured by screws. 4pin receptacle is mold-in; 2pin/7pin receptacles are press-fit.	Screw grounded 4pin receptacle. Spring lock 2pin/9pin receptacles. Plastic, waterproof. Ideal for small servo motors.	Hybrid structure enables both power and signal. Terminals compatible with AWG#14-24. Mechanical lock for secure mating. IP67 rated.	Miniature cable relay connector for compact servo motors. Simple, one-touch latch locking. Compact and Lightweight for ease of use in tight spaces.	Low force locking lever. Modular insulator structure for custom power and signal combination requirements, with EMI shielding option.

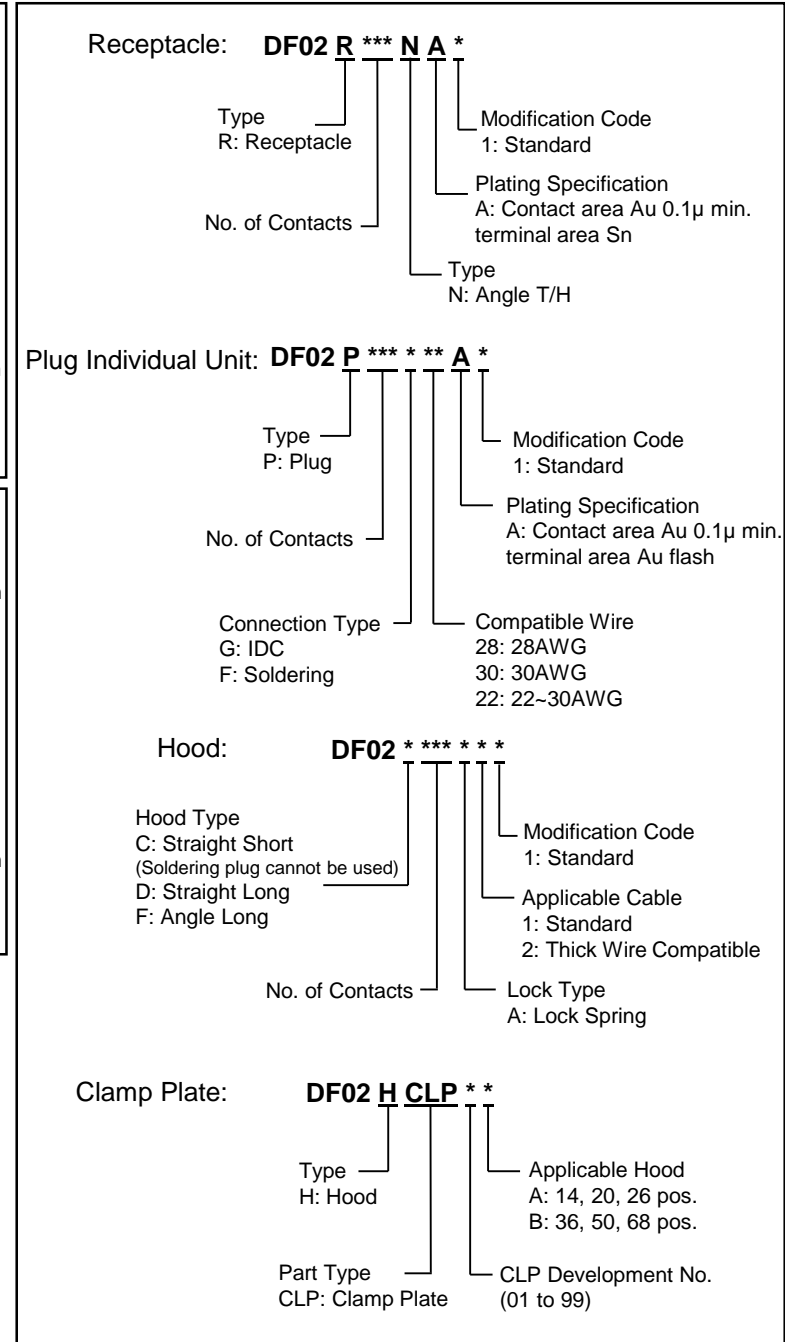
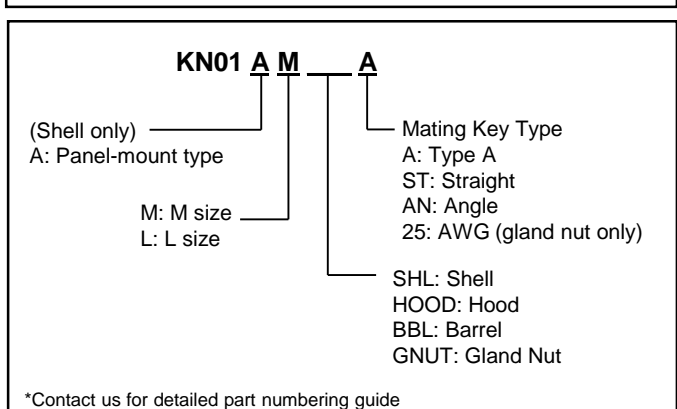
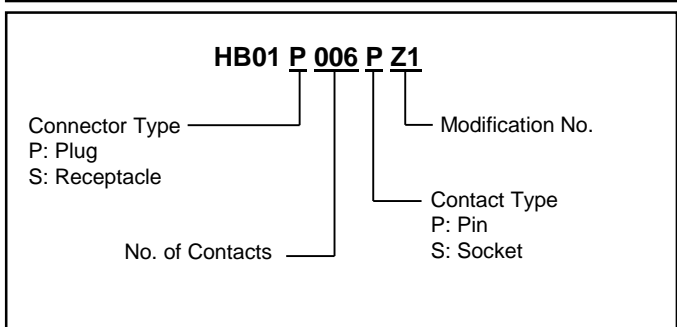
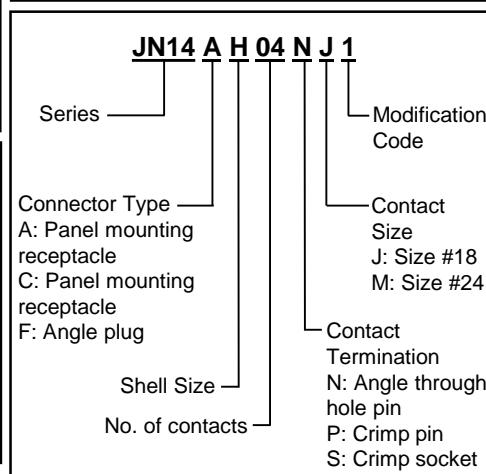
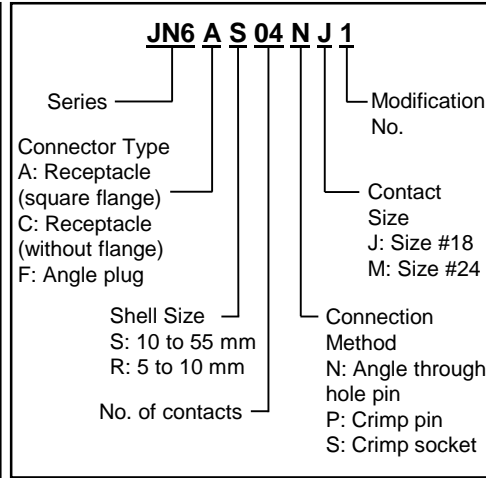
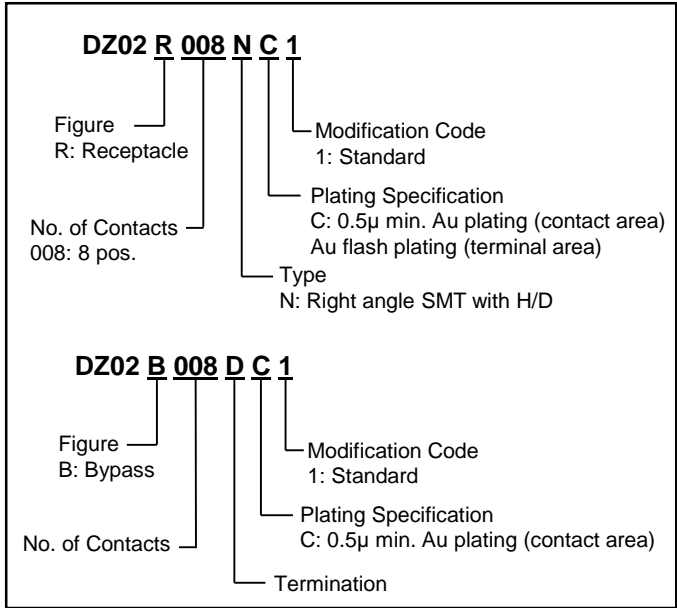

*Contact us for detailed part numbering guide

Industrial I/O Connectors [Circular] (1/2)

Series	JB5	JB1	JN1 / JN2	JN1W / JN2W	SRCN	JN1V/2V
Photo						
Plug Max Diameter	ø11.0mm	ø18.0mm	ø19.0mm	ø26.2mm	ø21.2-33.2mm	ø19.0mm
Pin Count	3,4,5,6,8	3,5,10	4,10	5,15	3,5,7,10,16,24	10
Shell Material	Metal	Metal	JN1: Plastic JN2: Metal and Plastic	JN1W: Plastic JN2W: Metal and Plastic	Metal	JN1: Plastic JN2: Metal and Plastic
Mated Condition	IP68	IP67	IP67	IP67	N/A	IP67
Current Rating	2 ~ 3A	3A	3 ~ 5A	3 ~ 13A	5 ~ 10A	3A
Voltage Rating	200VAC ~ 320VAC	300VAC	200VAC	200VAC ~ 400VAC	1,000VAC	230VAC
Durability	5,000 cycles	500 cycles	500 cycles	500 cycles	500 cycles	500 cycles
Lock	Push-pull	Threaded	Push on, twist off	Push on, twist off	Threaded	Push on, twist off
Operating Temp	-55 ~ +85 °C	-30 ~ +85 °C	-20 ~ +125 °C	-20 ~ +125 °C	-25 ~ +85 °C	-20°C to +125°C
Wire Size	AWG #22-28	AWG #22-28	AWG #20-28	AWG #14-28	AWG #16-20	AWG #20-28
Termination	Solder	Crimp	Crimp / Solder	Crimp / Solder	Solder	Crimp
Features	Small size, Unmated waterproof.	Mated Waterproof	One-touch locking mechanism. JN2 shell is 3x stronger.	One-touch locking mechanism	UL approved, 5 insert guide keys.	Increased socket contact points to withstand 25G vibration. Mates with conventional JN1/JN2 receptacle. One-touch locking.

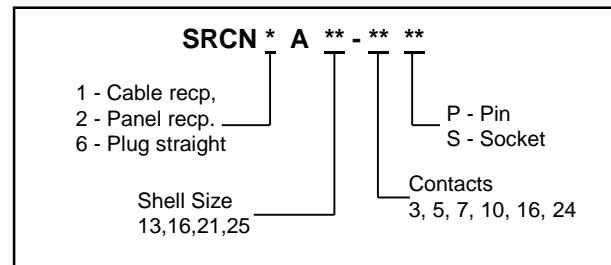
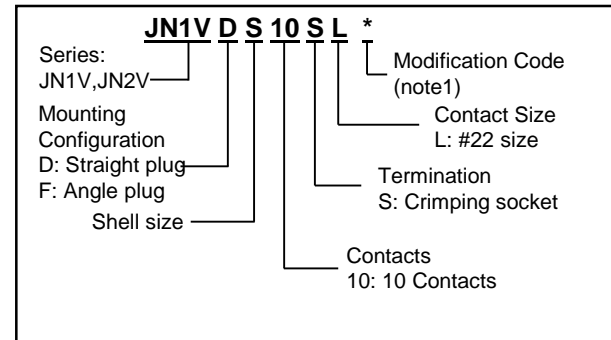
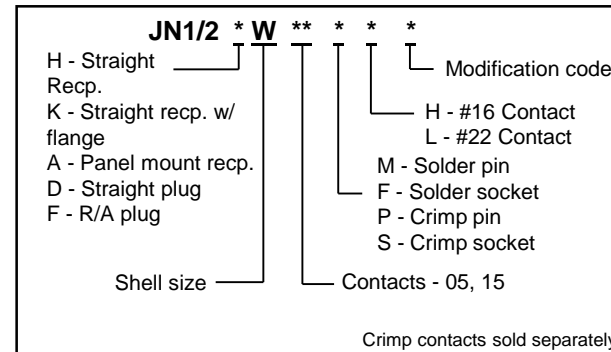
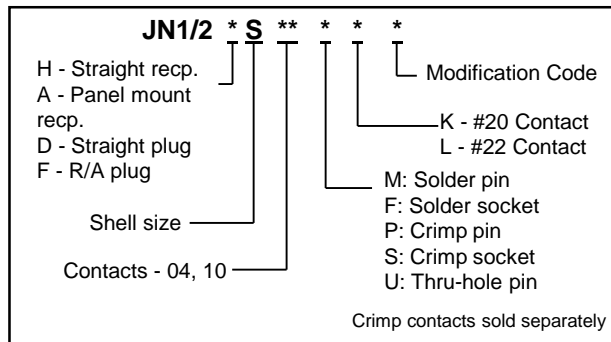
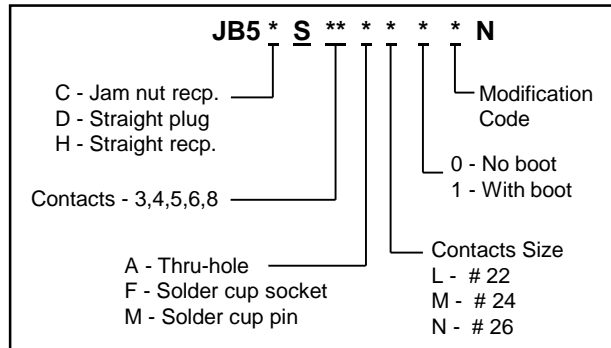
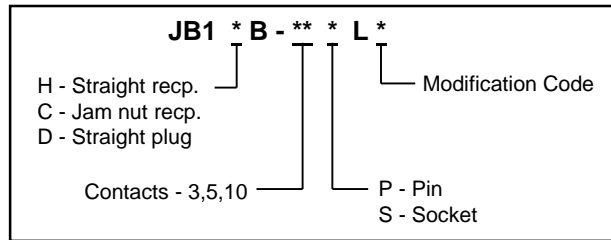

Industrial I/O Connectors [Circular] (2/2)

Series	JB10	JL02	JL04V	JL05	JL10	JK06	N/MS
Photo							
Plug Max Diameter	ø34.0mm	ø34.1-62.7mm	ø22-56.3mm	ø35.9-51.7mm	ø35.9-58.6mm	ø36.5-66.3	ø22.2-81.8mm
Pin Count	26	10,17,19,24, 37,48,54	3,4,6,7,8,9,22	4,5,7,8,9,10, 17,19,24,30, 36,37, 52,73	4,9,17,19, 22,37	10,37,48	1~11,14,16, 17,19,22,24, 26,35,37, 48,54
Shell Material	Plastic	Metal	Metal	Metal	Metal	Metal	Metal
Mated Condition	IP67 (mated)	N/A	IP67	IP67	IP67	IP67	N/A
Current Rating	1A	1.5 ~ 13A	13 ~ 80A	2 ~ 46A	13 ~ 80A	13 ~ 124.8A	13 ~ 150A
Voltage Rating	100VAC	200VAC ~ 500VAC	100VAC ~ 500VAC	200VAC ~ 900VAC	100VAC ~ 500VAC	220VAC	200VAC ~ 3,000VAC
Durability	500 cycles	500 cycles	500 cycles	500 cycles	500 cycles	500 cycles	500 cycles
Lock	One-touch (push-and-twist)	Threaded	Threaded	Bayonet	Bayonet and Threaded	Bayonet	Threaded
Operating Temp	-20 ~ +125 °C	-55 ~ +85 °C	-55 ~ +125 °C	-55 ~ +125 °C	-55 ~ +125 °C	-55 ~ +85 °C	-55 ~ +125 °C
Wire Size	AWG #20-28	AWG #14-28	AWG #4-18	AWG #8-26	AWG #0-22	AWG #14-16	AWG #0-16
Termination	Crimp	Crimp	Solder	Crimp / Solder	Solder	Crimp	Solder
Features	Internal EMI shielding. One-touch, push-and-twist for easy locking and unmating.	Compatible with MIL-DTL-5015 standard.	TUV and UL approved. Compatible w/ MIL- DTL-5015.	JIS B 9960-1 compatible	TUV and UL approved. Compatible w/ MIL- DTL-5015.	Panel-to-cable connector, VG95234 design.	UL approved. Compatible with MIL-DTL-5015 standard.

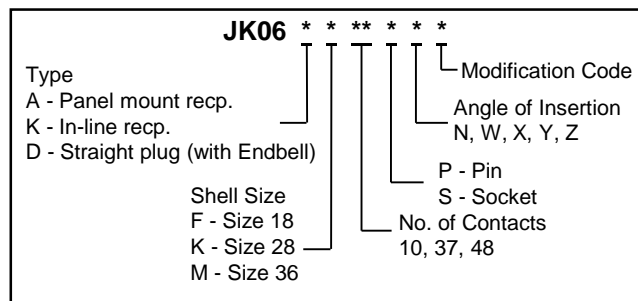
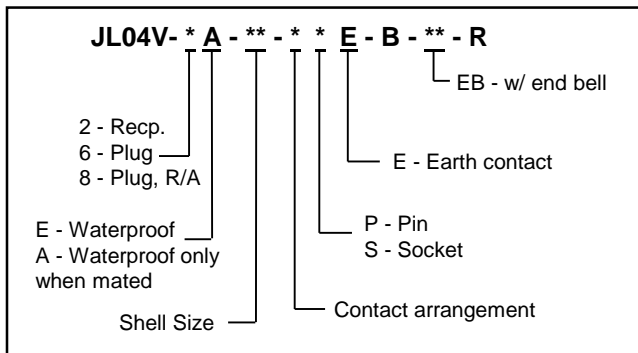
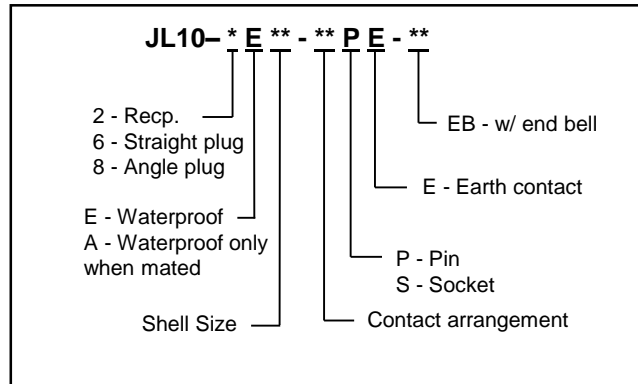
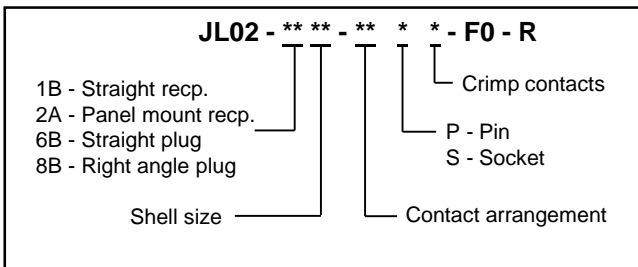
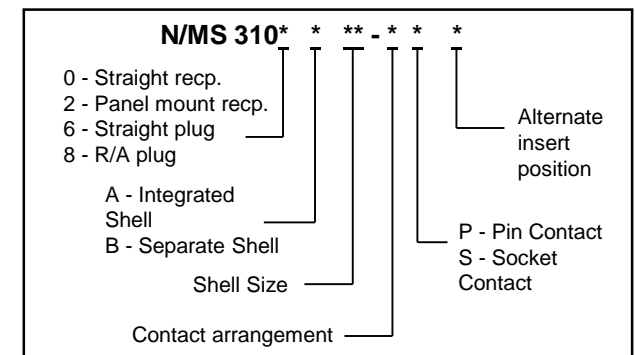
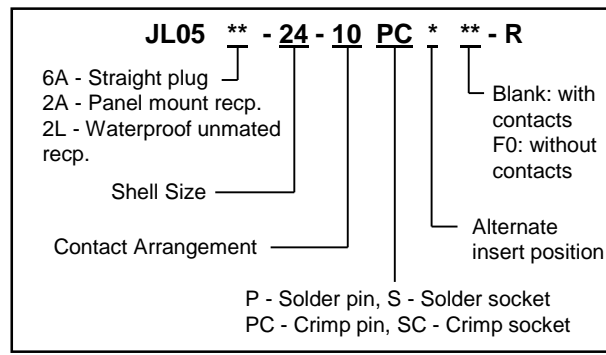
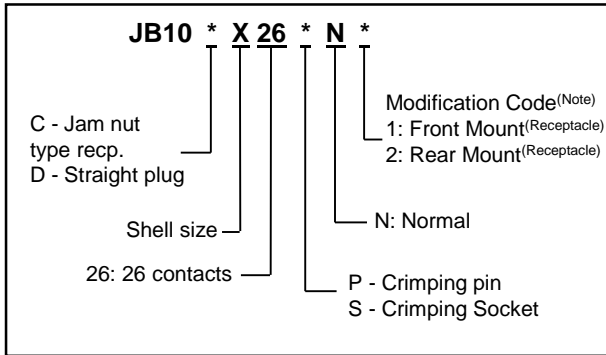

Board-to-Cable Connectors

Series	FI-JZ	FI-JW	HJ1	HD*	FI-R	FI-X	FI	
Photo								
Pitch	0.25mm	0.3mm	0.4mm	0.5mm	0.5mm	1.0mm	1.25mm	1.25mm
Discrete Wire AWG	N/A	N/A	#34,36	#32,34,36	#30,32,36	#30,32,36	#28,30,32	#28,30,32
Coax Wire AWG	#44,46 (OD≤0.25)	#42,44	#36,38,40,42,44	#36,38,40,42,44	#40	#32,40	N/A	N/A
FPC/FFC	N/A	N/A	N/A	N/A	JF08 Assembly	0.14±0.03mm	0.14±0.03mm	N/A
Pin Count	50	30, 34,40, 50	50	40	21,31,41,51	30	2-6,8,10,15, 20, 25,30	5,7,9,11,13,15,17, 19,21, 31,41
Mated Height	0.9mm	1.65mm	0.9mm	1.0mm	3.8mm	1.0-2.35mm	1.8mm	3.7mm
Locking	Friction	Friction	Friction/Pull Bar	Friction/Pull Bar	Latches	Latches	Latches	Latches
Durability	20 cycles	30 cycles	30 cycles	30 cycles	50 cycles	50 cycles	50 cycles	50 cycles
Current Rating	0.2A	0.25A	0.1A to 1.0A	0.1A to 1.0A	0.8A	1.0A	1.0A	1.0A
Voltage Rating	50V	50V	100V	100V	200V	200V	200V	200V
Features	Smallest size. Ideal for routing through small openings such as hinges.	Vertical mating. Small footprint.	Ground reinforced design. Lowest profile.	Compatible with VESA standard for LED backlit panels. <small>LICENSED BY DAI-ICHI SEIKO CO., LTD. (I-PEX)</small>	VESA standard for LCD interface of HD TV. Vertical mount available.	VESA standard for 1.0mm pitch LVDS interface.	Single row for low profile.	Dual row for smaller footprint.

*Specs shown for HD1 only

Receptacle: **FI - JZ50S - VF08 - R3000**

Cable Plug: **FI - JZ50C - R6000**

Plug Shell: **FI - JZ50C - SH1 - 12000**

Only orderable in reels

Receptacle: **HJ1S050HA1R6000**

Cable Plug: **HJ1P050MA1R6000**

Cover Shell: **HJ1P050-CSH1-10000**

Pull Bar: **HJ1P050-PB1**

Orderable in reels

Receptacle: **FI - X 30S L - HF**

B: Mid mount ———— L: Locking latches
S: Stronger shell ———— R: Reverse

Cable Plug: **FI - X30H**

H: Discrete wire crimp ———— L: Locking latches
C, C2, C2E: Coax wire
MA1, FR: FPC/FFC

Crimp Contacts: **FI-XC3B-1-15000**

Hand Crimp Tool: **CT150-4C-FIX**

Semi-Auto: **3502-FI-2B**

Receptacle: **FI - JW##S - VF16**
Orderable in reels

Cable Plug: **FI - JW##C - R3000**
Only orderable in reels

Plug Shell: **FI - JW##C - SH 1 - 9000**
Only orderable in reels

Ground Bar: **FI - JW##C - BGB - S - 6000**

Cover: **FI - JW##C - CGB - S - 9000**
Only orderable in reels

Receptacle: **HD1S040HA1R6000**

Cable Plug: **HD1P040MA1R6000**

Cover Shell: **HD1P040-CSH1-10000**

1: Discrete wire
2: Coax wire

Pull Bar: **HD1P040-PB1**

*Licensed by I-PEX, Co., Ltd. Orderable in reels

Single Row

Receptacle: **FI - S_##P - HFE**

Cable Plug: **FI - S_##S**

E: EMI Shell ———— S: Discrete wire crimp
(Only for 20 pos, FPC) ME: FPC/FFC
MRE: Rev. FPC/FFC

Dual Row

Receptacle: **FI - TWE##PB - VF** Vertical
FI - W_##P - HFE Right angle
E: EMI Shell

Cable Plug: **FI - W##S**

Crimp Contacts: **FI-C3-A1-15000**

Hand Crimp Tool: **CT150-4C-FI**

Semi-Auto: **3502-FI-2B**

Receptacle: **FI - R_##S - HF**

E: EMI shell ———— H: Horizontal
V: Vertical

Cable Plug: **FI - R_##H**

E: EMI shell ———— L: Locking Latches
H: Discrete wire crimp
C: Fine-wire coaxial









Cover Shell: **FI - RE ## CL- SH2 - 3000**
Only for coax cable plug

Crimp Contacts: **FI-RC3-1A-1E-15000 (upper)**
FI-RC3-1B-1E-15000 (lower)

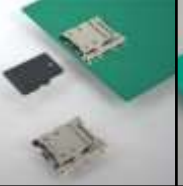
Hand Crimp Tool: **CT150-4C-FIR**

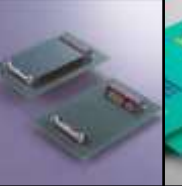
Semi-Auto: **3502-FI-2B**

Card Connectors 1 (microSD, CF, DIMM, PCIe, M.2, MXM 3.0)

Series	ST1	ST11	ST12	ST19	ST50	MM60	MM70	MM80	JC26/C2	SM3
Photo										
Card	microSD	microSD	microSD	microSD and nano SIM combo	microSD (UHS-II)	PCI Express Mini Card	MXM 3.0 Graphics Card	DDR3 SDRAM SODIMM	Compact Flash	M.2 (NGFF)
Mounted Height	1.9mm, 1.4mm	1.25mm	1.4mm	1.3mm	1.35mm	2.125, 4.0, 5.9mm	4.3, 6.7mm	5.2, 9.2mm	5.8mm, 7.4mm	1.2, 2.15, 3.1, 4.1mm
Pin Count	8, 8+2	8+2	10+2	20+2	17+2	52,76	314	204	50	67
Voltage Rating	10V rms	10V rms	10V rms	50VAC rms	10V rms	50VAC rms	50V DC	200V AC rms	N/A	50V AC rms
Current Rating	0.5A	0.5A	0.5A	0.5A	0.5A	0.5A	0.5A	0.3A	0.5A	0.5A
Durability	10,000 cycles	5,000 cycles	10,000 cycles	2,500 cycles	5,000 cycles	50 cycles	30 cycles	25 cycles	10,000 cycles	60 cycles
Style	Hinged	Push-Push	Push-Push	Pin Eject Tray	Push-push	Card Edge	Card Edge	Card Edge	Ejector	Card Edge
Features	Available with card detection switch. Smallest footprint & lowest height for hinged type.	Strong mechanical lock to prevent card from popping out from vibration and shock.	2 extra contacts included for RF cards. Easy SMT solder inspection.	3 in 2 combo connector can house a nano SIM and either an additional nano SIM or a microSD.	Compatible with ultra high speed data transmission standard UHS-II for transferring large files quickly.	Retention latch or screw hold downs available to fix module to connector and main PCB.	MXM3.0 standard compatible. Available in 2 heights.	DDR3 SO-DIMM connector compatible w/ JEDEC standard MO-268C.	Reverse mount available. Retractable ejector available.	Multiple key and heights variations available.

MicroSD: **ST1W008S4 A R1500**
 Hinged type
 Modification code

MicroSD: **ST1W008S4 G R2000**
 Low profile
 Hinged type
 G: W/out detect switch
 T: With detect switch
 X: Cover detect switch

MicroSD: **ST11S008V4HR2000**
 Push-push type

MicroSD: **ST12S010VBAR1800**
 Push-push type

MicroSD: **ST19S020VCAR1400**
 Combo tray type

MXM 3.0 Graphics Card

Connector: **MM70- 314-310 B 2 - 1**

Height modification code
 1: 3.0mm
 2: 1.5mm

Contact finish:
 (Au plating)
 1: 0.1µm min.
 2: 0.3µm min.

DDR3 SDRAM SO-DIMM

Connector: **MM80 - 204B1 - E1R**

Height modification code
 Blank: 5.2
 E: 9.2

Blank: Standard
 R: Reverse

PCI Express Mini Card

Connector : **MM60 - 52 - B 1 - E 1**

No. of contacts
 Socket type
 B: Top mount
 C: Mid mount

Key type

Contact finish

Height modification code

Latch : **MM60 - EZ - H059 - B 5**

Latch type

Connector height

With boss

5: Sn plating

Nut : **NT1R3000** 4.0mm height connector
NT4R1600 5.9mm height connector

DDR2 MicroDIMM

Female side: **WA6F214VA1T**

Male side: **WA6M214VA1T**

M.2 (NGFF)

Connector: **SM3 Z S 067 U 310 ****

No. of contacts

Mounting Type:
 U: On-board
 B: Mid mount

Connector Height:
 120: 1.20mm
 215: 2.15mm
 310: 3.10mm
 410: 4.10mm

Polarizing key:
 A/B/E/M

Contact finish:
 (Au plating)
 A: 0.13µm
 B: 0.25µm

Nut : **SM3ZS067U215-NUT1** 2.15mm connector
SM3ZS067U310-NUT1 3.1mm connector
SM3ZS067U410-NUT1 4.1mm connector

CompactFlash

Connector: **JC26A - BB * E**

Blank: Standard
 16: +1.6mm

Frame: **JC26C2 - D S R E**









D: Push-push ejector
 F: Fixed ejector

S: Standard
 R: Reversed

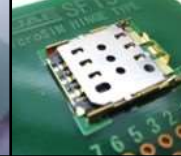
Blank: Standard
 16: +1.6mm

R: Right, flip
 L: Left, flip
 M: Right, fixed
 H: Left, fixed

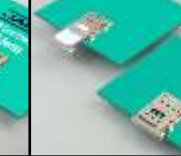
Card Connectors 2 (SIM, Micro SIM, Nano SIM)

Series	SF7	SF8	SF9	SF15	SF53	SF56	SF58	SF70	SF72	SF78
Photo										
Card	SIM	SIM	SIM	Micro SIM	Micro SIM	Micro SIM	Micro SIM	Nano SIM	Nano SIM	Nano SIM
Mounted Height	1.9mm/1.4mm	1.5mm	1.8mm	1.55mm	1.45mm	1.25mm	1.3mm	1.25mm	1.25mm	1.3mm
Pin Count	6, 6+2	6	6	6	6	6+2	6+2	6+2	6+2	12+2
Card/Tray Detect Switch	Available	Without switch	Without switch	Without switch	Without Switch	With Switch	With Switch	With Switch	With Switch	With Switch
Current Rating	1A	1A	1A	0.5A	0.5A	0.5A	0.5A	0.5A	0.5A	0.5A
Durability	5,000 cycles	5,000 cycles	5,000 cycles	1,500 cycles	1,500 cycles	5,000 cycles	5,000 cycles	5,000 cycles	5,000 cycles	2,500 cycles
Style	Hinged	Push-Pull Tray	Push-Pull Tray	Hinged	Push-Pull	Push-Push	Pin Eject Tray	Pin Eject Tray	Push-Push	Pin Eject Tray
Features	Reliable locking structure. Positioning boss, metal cover available.	Lowest profile for tray type connector. Normal and reverse mount available.	Normal and reverse mount available. 5 hold-downs for EMI and ESD prevention.	Small footprint and height. Clear click feeling to indicate when cover is locked.	Unique contact design to prevent damage from angled insertion and use with card adapters.	Smallest in class height. Long eject length for ease of use.	Low profile and narrow design. Strong lock design for high tray retention.	Small size for compact portable devices. Strong lock design for high tray retention.	Low profile; Special contact shape for enhanced reliability.	Low profile dual SIM connector can house 2 nano SIM cards at the same time.

SIM: **SF7W 006 S 1 A**

Hinge type

006: 6 position
008: 6 signal + 2 switch

A: Positioning boss
B: No boss
E: Low profile

1: Standard
4: Low profile

Micro SIM: **SF15W006S4BR2000**

Hinge type

Micro SIM: **SF58S006VBAR2000**

Tray type

Please contact JAE for recommended dimensions of the tray.

SIM: **SF8V006S4AR1200**

Tray type

A: Standard
B: Reverse

Tray: **SF8-STS1-A** Standard
SF8-STR1-B Reverse

Need both Connector and Tray to use SF8 series

Micro SIM: **SF53S006VCBR2000**

Push-Pull type

Nano SIM: **SF70S006VBAR2000**

Tray type

Please contact JAE for recommended dimensions of the tray.

SIM: **SF9W006S4AR1200**

Tray type

Tray: **SF9-STS1-A** Standard

Need both Connector and Tray to use SF9 series

Micro SIM: **SF56K006VBAR2000**

Push-Push Type

Nano SIM: **SF72S006VBDR2500**







Push-Push type

Nano SIM: **SF78S012VBAR1400**

Tray type

Please contact JAE for recommended dimensions of the tray.

LED Lighting Connectors

Series	ES3	ES3 (WF2)	ES3 (JF3)	ES5	ES6	ES9	ES10
Photo							
Applicable Wire Size	N/A	#22,24,26	#24,26 (solid)	#22,24,26	N/A	#22,24,26	#24,26 (solid)
Pin Count	2	2	1	1	2	2,4	1
Height	1.6mm (above board)	1.65mm (above board)	2.9mm	1.6mm	1.55mm (above board)	3mm	2.2mm
Locking	Friction	Latch	Friction	Latch	Friction	Friction	Friction
Durability	20 cycles	20 cycles	5 cycles	20 cycles	20 cycles	10 cycles	5 cycles
Current Rating	1.0A	2.0A	2.0A	4.0A	1.0A	3.0A (4 pos.) 4.0A (2 pos.)	2.0A
Voltage Rating	200V	200V	N/A	N/A	250V	300V	N/A
Operating Temperature	-40 ~ +105 °C	-40 ~ +105 °C	-40 ~ +105 °C	-40 ~ +105 °C	-40 ~ +105 °C	-40 ~ +105 °C	-40 ~ +105 °C
Features	Card edge connector that eliminates the need for wires to connect between boards.	Mechanical lock included for use in applications with vibration and shock.	Tapered insertion for easy mating. No harness assembly required.	Special lock structure that has a clear "click" feeling for secure mating.	Smallest size. Card edge connector design to reduce components and labor.	Spring lock structure provides high vertical and horizontal retention strength.	Compact structure with no insulator allows design flexibility. Easy single wire insertion.

ES3-WF1 Series (Card Edge type)

Receptacle: **ES3B002WF1R1000**



ES3-JF3 Series (Cable insertion type)

Receptacle: **ES3S001JF3R3300**



ES3-WF2 Series (Board-to-Wire type)

Receptacle: **ES3B002WF2R1000**

Housing: **ES3S002SZA**

Contact: **IL-Z-C1-A-7000**

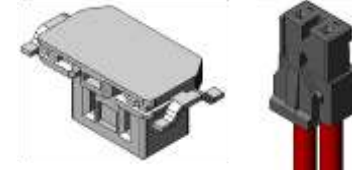

ES5 Series

Receptacle: **ES5S001JFAR5500**



Cable Plug: **ES5P09K5FA**
#24-26AWG

Cable Plug: **ES5P09K4F2**
#22AWG



ES6 Series

Receptacle: **ES6B002WF1R1000**

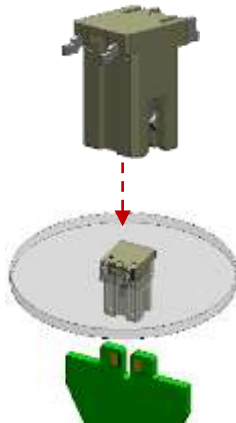

ES9 Series

Receptacle: **ES9P 00# VF1R1600**

No. of contacts:
002: 2
004: 4

Plug (housing): **ES9S 00# SZA**

No. of contacts:
002: 2
004: 4

Contact: **ES9S06K4FA**







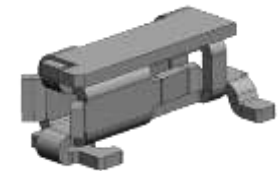



ES10 Series

Receptacle: **ES10S001JF1R5500**



High-Power Connectors

Series	DW1	DW2	DW3	DW4	DW05	DW07	KB1	KW1	KW03
Photo									
Type	Rack-and-Panel	Rack-and-Panel	Rack-and-Panel	Board-to-Cable	Cable-to-Cable	Bus bar-to-Bus bar	Cable-to-Cable	Plug + Cable	Plug + Cable
Pin Count	Power: 2 Signal: 20	Power: 2 Signal: 20	Power: 2 Signal: 24	1	1	N/A	1	Power: 2 Signal: 7	Power: 2 Signal: 8
Current	Power: 500A Signal: 2A	Power: 200A Signal: 2A	Power: 150A Signal: 2A	100A	150A	Current value (in A) that temperature rise will be 30 K or 65 K x safety ratio (80%)	25A max. (KB1-12-PC/SC) 10A max. (KB1-12-PC2/SC2)	Power: 125A Signal: 2A	Power: 80A Signal: 2A
Voltage Rating	Power: 600V Signal: 100V	Power: 600V Signal: 100V	Power: 600V Signal: 100V	600V	600V	N/A	1000VDC / 6000VAC Pollution Degree: 3 Over Voltage Category: III	DC500V	DC450A
Durability	20 cycles	100 cycles	100 cycles	50 cycles	100 cycles	100 cycles	50 cycles	10,000 cycles	10,000 cycles
Floating Range	+/- 2.75mm	+/-2.75mm	+/-2.0mm	N/A	N/A	+/-2.5mm	N/A	N/A	N/A
Operating Temp	-40 ~ +95 °C	-25 ~ +115 °C	-25 ~ +105 °C	-40 ~ +75 °C	-40 ~ +85 °C	-25 ~ +105 °C	-40 ~ +90 °C	-10 ~ +40 °C	-30 ~ +40 °C
Features	Robust high-power and signal hybrid for large battery modules. Floating for easy and blind mating.	200A for mid-range power solutions. Signal and power hybrid. Floating for easy and blind mating.	Low-profile to fit 1U form-factor battery rack. Power plus signal. Floating for easy and blind mating.	Secure cable connector for high-power. Color-coded and keyed to prevent mating errors. Offered as harness.	Keyed cable-to-cable connector for safe high-power mating. Screw holes for easy mounting.	Innovative busbar connector solution without screws or insulator. Clip mounting, no tools necessary.	High-current interconnect connector for solar panel module.	One-touch operation and light-weight for easy handling. UL recognized. Weather and impact resistant.	One-touch operation and light-weight for easy handling. UL recognized. Weather and impact resistant.

DW1 * 002 Z H 1

R: Receptacle
P: Plug

No. of Contacts
002: 2 pos. (shown in 3 digits)

Modification Code
H: Ag plating

Plating of Contact Area
Z: Others

Connection Type

DW1 * 020

R: Receptacle
P: Plug

No. of Contacts
020: 20 pos. (shown in 3 digits)

DW1 * 04K 4 F 1

S: Crimp, socket
P: Crimp, pin

No. of Contacts
04K: 4000 pcs.

Reel Part Number
K: unit of 1000 pcs. (Note 1)

Modification Code
F: Sn plating

Plating of Contact Area
4: 22AWG

Applicable Cable Size

Note 1: An embossed reel contains 4,000 pcs.

DW2 * 002 Z H 1

R: Receptacle
P: Plug

No. of Contacts
002: 2 pos. (shown in 3 digits)

Modification Code
H: Ag plating

Plating of Contact Area
Z: Others

Connection Type

DW2 * * ***

R: Receptacle
P: Plug

Modification Code (Plug side only)

No. of Contacts
010: 10 pos.
020: 20 pos. (shown in 3 digits)

DW1 * 04K 4 F 1

S: Crimp, socket
P: Crimp, pin

No. of Contacts
04K: 4000 pcs.

Reel Part Number
K: unit of 1000 pcs. (Note 1)

Modification Code
F: Sn plating

Plating of Contact Area
4: 22AWG

Applicable Cable Size

Note 1: An embossed reel contains 4,000 pcs.

DW3 * 002 Z H 1

R: Receptacle
P: Plug

No. of Contacts
002: 2 pos. (shown in 3 digits)

Modification Code
H: Ag plating

Plating of Contact Area
Z: Others

Connection Type

DW3 * 012 A

R: Receptacle
P: Plug

Modification Code

No. of Contacts
012: 12 pos. (shown in 3 digits)

DW* * 04K 4 F 1

1: Standard
3: Long Pin

S: Crimp, socket
P: Crimp, pin

No. of Contacts
04K: 4000 pcs.

Reel Part Number
K: unit of 1000 pcs. (Note 1)

Modification Code
F: Sn plating

Plating of Contact Area
4: 22AWG

Applicable Cable Size

Note 1: An embossed reel contains 4,000 pcs.

DW4 * 001 Z F 1

P: Plug (with Cable)

No. of Contacts
001: 1 pos. (shown in 3 digits)

Modification Code
F: Sn plating

Plating of Contact Area
Z: Others

Connection Type

DW4R 001 W 00 12880

No. of Contacts
001: 1 pos. (shown in 3 digits)

Connection Type
W: Ultrasonic wave

Last five digits of SJ No.
12880

Modification Code

DW05 * 01 C ** *

S: Socket
P: Pin

No. of Contacts
01: 1 contact

Modification Code

Plating of Connection Area
AG: Silver
ZZ: Others

Connections
C: Cable

KB1 J S 01 * G * L

Cable Connecting Type

Shell Size

No. of Contacts

S: Crimp Type Socket Contact
P: Crimp Type Pin Contact

Modification Code
L: With Unlock Tab

Applicable Cable O.D.
1: 7.0mm in dia.
2: 6.4mm in dia.

Contact Size

DW07 S 01 B AG *

S: Socket

No. of Contacts
01: 1 contact

Modification Code

Plating Specification
AG: Silver

Connected to
B: Busbar

KW* G Y 09 P D L** ****

Series 1 & 03

Angle Plug

Shell Size

No. of Contacts

Crimp

Modification Code
E1: CE Compliant Products
U1: UL/cUL Recognized Products

Cable Length L (cm)

Contact Size

Transportation (1/3)

Series	MX19	MX23A	MX36	MX37	MX44	MX47
Photo						
Pitch	2.5mm	2.5mm	2.5mm	2.2mm	3.5mm	2.5mm
Wire Size	AWG #22-20 CAVS: 0.3 to 0.5mm ² AVSS: 0.5mm ²	AWG #22-16 AVSS, AVS: 0.5 to 1.25mm ²	AWG #20 AVSS 0.5, AVSS 0.5F, AVSSX 0.5f, TVSSX 0.5f	AWG #20 AVSS 0.5, AVSS 0.5F, AVSSX 0.5f, TVSSX 0.5f	AWG #22-20 AVSS 0.3 to 0.5mm ²	AWG #22-16 AVSS 0.3 to 1.25mm ²
Pin Count	2,3*,4	12,18,26,34,36,40	2,4	4	2,4,6	39
Current Rating	5A	3A	3A	3A	3A	3A
Operating Temp	-40 ~ +85 °C	-40 ~ +125 °C	-40 ~ +125 °C	-40 ~ +105 °C	-40 ~ +125 °C	-40 ~ +125 °C
Application	Cable-to-Cable	Board-to-Cable	Cable-to-Cable	Cable-to-Cable	Board-to-Cable	Board-to-Cable
Features	<p>Waterproof. Mechanical lock system. Grommet seal. Terminals have low insertion force and stress dispersion. Rear cover protects the grommet from damage.</p> <p>*Only socket housing available for 3 pin option</p>	<p>Waterproof. Low profile. Available in reverse mount type. Retainer detects incomplete insertion of socket contact.</p>	<p>Waterproof. Spring separates connectors if not correctly mated. Shorting contact eliminates static discharge. Retainer detects incomplete insertion of socket contact.</p>	<p>Mechanical complete mating method. Spring separates connectors if not correctly mated. Shorting contact eliminates static discharge. Retainer detects incomplete insertion.</p>	<p>Single contact waterproof. Compact size. Improved vibration resistance by vibration absorption function of rubber. Secondary lock mechanism.</p>	<p>Waterproof. Different key option available. Retainer detects incomplete insertion of socket contact.</p>

Socket housing: **MX1900#S51**
 Pin housing: **MX1900#P51**
 *3 pin version
 Socket housing: **MX19A003S51**

1: Black
 2: Gray

Contacts: MX19S10K451 (socket)
 MX19P10K451 (pin)
 Dummy pin: MX1900XD1

Hand Tool: CT150-4C-MX19
 Semi auto: 3502-MX19-2B

Socket housing: **MX44###SF1**
 Pin header: **MX44###NF1**
 Retainer: **MX44###XR1**
 Wire seal: **MX44000XP1**

Contacts: M44S05K4F1

Hand Tool: CT150-2-MX44
 Semi Auto: 3502-MX44-2

Wire O.D.
 1, 1.4-1.5mm
 2: 1.6-1.7mm

Socket housing: **MX23A##SF1**
 Pin header: **MX23A##NF1**
 Front cap: **MX23A##XF1**

1: Standard
 2: Reverse

Contacts: M23S05K351
 Dummy pin: M120-55780

Hand tool: CT160-3B-MX23
 Semi auto: 350-MX23-2

Socket housing: **MX47037SF1**
 Pin header: **MX47037NF1**
 Front cap: **MX47037XF1**

Key code: 1,2

Contacts	M47S65H2FA	M47S65H3FA	M47S65H4FA
Wire Size (AWG)	#22-20	#18	#16

Socket housing: **MX3600#SQ3**
 Pin housing: **MX3600#PQ3**
 Front cap: **MX36004XF3**

Contacts: M36S08K4Q3 (socket)
 M36P08K4Q3 (pin)

Semi auto: 350-MX36-2
 Automatic: 350-MX36-3B

Socket housing: **MX37004SP3**
 Pin housing: **MX37004PP3**

	Socket	Pin
Contacts:	M37S07K4P3	M37P75C4P3
Semi Auto:	350-MX37S-2	350-MX37P-2
Automatic:	350-MX37S-3B	350-MX37S-3B

Transportation (2/3)

Series	IL-AG5	IL-AG9	MX31	Standard T/H	MX34 Vertical SMT	Right Angle SMT	MX77A	MX84B
Photo								
Pitch	2.5mm	2.5mm	Signal: 2.2mm Power: 3.2mm	2.2mm	2.2mm	2.2mm	Signal: 1.8mm Power: 2.1mm	2.2mm
Wire Size	AWG #22-20 AWG #18 AV, AVS, AVSS: 0.3 to 0.5 mm ² AVS, AVSS: 0.85 mm ²	AWG #22-20 AWG #18 AV, AVS, AVSS: 0.3 to 0.5 mm ² AVS, AVSS: 0.85 mm ²	Signal: AWG #22-20 Power: AWG #22-16 Signal: AVS, AVSS, AVX 0.3 to 0.5mm ² Power: AVS, AVSS, AVX 0.3 to 1.25mm ²	AWG #22-20 AVSS: 0.3, 0.5mm ² CHFUS: 0.22 to 0.75mm ² , CAN SD: 0.35mm ²	AWG #22-20 AVSS: 0.3, 0.5mm ² CHFUS: 0.22 to 0.75mm ² , CAN SD: 0.35mm ²	AWG #22-20 AVSS: 0.3, 0.5mm ² CHFUS: 0.22 to 0.75mm ² , CAN SD: 0.35mm ²	AWG #36-32 CHFUS, CIVUS: 0.13, 0.22, 0.35mm ² AVSS: 0.3mm ²	AWG #22-20 AVSS: 0.3, 0.5mm ² CHFUS: 0.22 to 0.75mm ² , CAN SD: 0.35mm ²
Pin Count	1 row: 4,5,6,7,10 2 rows: 14,16,18,22,30	2,3	Pin: 70,98,104,135 Socket: 31,34,35	3,5,7,8,12,16,20,24,28,32,36,40	12,20,32	3,5,7,8,12,16,20,24,32,36	4,8,12,16,20,24,32,40	20,28
Current Rating	3A	3A	Signal: 2.2A Power: 5.7A	3A	3A	3A	3A	3A
Operating Temp	-40 ~ +85 °C	-40°C ~ +85 °C	-40 ~ +85 °C	-40 ~ +85 °C	-40 ~ +85 °C	-40 ~ +85 °C	-40 ~ +85 °C	-40 ~ +85 °C
Application	Cable-to-Cable/ Board-to-Cable	Cable-to-Cable	Board-to-Cable	Board-to-Cable	Board-to-Cable	Board-to-Cable	Board-to-Cable	Board-to-Cable
Features	Mechanical lock system enabling complete mating. Secondary lock mechanism to ensure correct terminal retention. Simplified crimp type termination.	Mechanical lock system enabling complete mating. Double hook mechanism to prevent contacts from being inserted or removed incompletely.	Mechanical lock system with audible click. Socket side contact designed with secondary lock. Simplified crimp type termination.	Mechanical lock system. Secondary lock mechanism to ensure terminal position. Simplified crimp type termination. Thru hole terminals.	Vertical mount SMT header. Mechanical lock system. Secondary lock mechanism to ensure terminal position. Simplified crimp type termination.	Horizontal mount SMT header. Mechanical lock system. Secondary lock mechanism to ensure terminal position. Simplified crimp type termination.	Extreme reduction in height to fit in slimmer ECU modules. SMT reflow compatible connector. Secondary lock mechanism to ensure terminal position.	UL94 V-0 flammability rating insulator. Mating and PCB footprint compatible with MX34.

Socket Housing: **IL-AG5-#S- S3C1**

Pin housing: **IL-AG5-#P- S3C1**

Pin header: **IL-AG5-#P- S3L2**

S: single row
D: double row

L: right angle
T: straight

Contacts: IL-AG5-C1-5000 (socket)
IL-AG5-PC1-5000 (pin)

Hand tool: CT150-1-AG5
Semi auto: 3502-AG5-2
Automatic: 350-AG5-3B

Socket Housing: **IL-AG9-#S- S3C1**

Pin housing: **IL-AG9-#P- S3C1**

Pin header: **IL-AG9-#P- S3L1-B**

S: single row
D: double row

L: right angle
T: straight

Contacts: IL-AG5-C1-5000 (socket)
IL-AG5-PC1-5000 (pin)

Hand tool: CT150-1-AG5
Semi auto: 3502-AG5-2
Automatic: 350-AG5-3B

Socket housing: **MX31 ### SGA**

31, 34, 35 pos ———— Modification code

Pin header: **MX31 ### N F D**

70, 104, 135 pos ———— Modification code

F: All Sn plated contacts
Q: Selective gold plated contacts

Contacts	Wire Size (AWG)
M31S07K4FA (Sn, signal)	#22-20
M31S07K4QA (Au, signal)	#22-20
M31S07K4FB (Sn, signal)	#24
M31S05K4FA (Sn, power)	#18-16
M31S05K4FA (Sn, power)	#22-18
M31S05K4QA (Au, power)	#22-18

T/H Pin header: **MX340##UF1**

U: Straight
N: Angled

Modification Code

Socket housing: **MX340##SF1**

SMT Pin header: **MX34R##VF1 ***

V: Straight
H: Angled

Blank: tube
T: tray

1: Straight
4: Angled

Contacts	M34S75C4F1	M34S75C4F2	M34S75C4F3	M34S75C4F4
Wire Size	0.22 – 0.35mm ²	0.5 – 0.75mm ²	0.35mm ²	0.85mm ²

SMT Pin header: **MX77A0##HF1**

H: Angled

Modification Code

Socket housing: **MX77A0##SF1**

Contacts	MX77S13K5F1	MX77S13K4F2	MX77S13K4F1
Wire Size	0.13mm ²	0.22mm ²	0.3, 0.35mm ²

T/H Pin header: **MX84B0##NF1**









N: Angled

Modification Code

Socket housing: **MX84B0##SF1**

*Contacts in common with MX34 Series

Transportation (3/3)

Series	MX35	MX38	MX39/MX45	MX48	MX49	MX50/53	MX55	MX62	MX65
Photo									
Pitch	N/A	2.0mm	2.2 mm	2.0mm	2.0mm	1.5mm	2.2mm	2.0mm	2mm
Wire Size	N/A	AWG #28 (Twin Ax)	AWG #28 Twin Ax	AWG #28 (Twin AX)	Signal: AWG #26 (Twin Ax) Power: AWG #20	AWG #28 (Twin Ax)	Signal/Power/ Ground # 26 (STQ)	Signal: AWG #26(Twin Ax) Power: AWG #22	0.14mm ² x4, 0.22mm ² x4 (STQ)
Pin Count	1	2	4	2	4	19	4	10	4, 4+2, 8
Current Rating	1A	Varies by cable type*	500 mA	Varies by cable type*	Signal: 0.5A	0.5A	Varies by cable type*	Power : 2.2A	1.5A
Operating Temp	-30 ~ +85 °C	-40 ~ +85 °C	-40 ~ +85 °C	-40 ~ +85 °C	-40 ~ +85 °C	-40 ~ +85 °C	-40 ~ +85 °C	-40 ~ +85 °C	-40 ~ +105 °C
Application	Board-to-Cable	Cable-to-Cable/ Board-to-Cable	Cable-to-Cable/ Board-to-Cable	Board-to-Cable	Cable-to-Cable/ Board-to-Cable	Cable-to-Cable/ Board-to-Cable	Board-to-Cable	Cable-to-Cable/ Board-to-Cable	Cable-to-Cable/ Board-to-Cable
Features	Conforms to FAKRA standard. Frequency range up to 4GHz. Available as straight or right angle. Multiple keying options.	Excellent in transmission of high-speed signals such as LVDS and GVIF. Different key options available.	USB 2.0 compatible, sold as complete harness with USB standard receptacle	Excellent in transmission of high-speed signals such as LVDS and GVIF. Different key options available. Extremely compact design.	Compatible with USB 2.0 signal speeds. Different key options available. Extremely compact design.	HDMI Type E compatible connector and harnesses. Cable mounted receptacle for mating with consumer HDMI cables is available.	Waterproof connector for LVDS transmission from digital cameras. Right angle and straight plug available.	Compatible with USB 3.0 signal transmission. Mechanical lock included. Double metal shield for improved EMI.	Mating compatible with HSD connectors. Waterproof and non waterproof variations available. Pin headers not provided by JAE.

*Contact us for more information.

Pin header: **MX35 # 01 N P1**

N: angle
 T: straight
 Different key code

Key Codes:

<u>Angle type</u>	<u>Straight type</u>
B: white	B: white
C: blue	C: blue
E: green	E: green
F: brown	F: brown
G: blue-gray	G: brown
H: violet	I: beige
K: yellow	

Board mounting receptacle: **MX50019NQ1**

JAE will supply the complete mating harness designed to customer specifications.

Board Mounting Receptacle: **MX38002FQ1**

Different key code: 1,2,3,4

Pin header: **MX38002NQ1**

JAE will supply the complete mating harness designed to customer specifications.

Camera back housing connector: **MX55A06ZB2**

Board mounting header: **MX55006KQ1R600**

JAE will supply the complete mating harness designed to customer specifications.

Board Mounting Receptacle: **MX39004NQ1**

USB Harness: **MX45004S0008397 (150mm)**

Board mounting header: **MX62010HQ1R100**

JAE will supply the complete mating harness designed to customer specifications.

Board Mounting Receptacle: **MX48002NQ1**

Different key code: 1,2,3,4

JAE will supply the complete mating harness designed to customer specifications.

MX65 Series Harness

JAE will supply the complete mating harness designed to customer specifications.

Board mounting receptacle: **MX49004 # Q 1**

N: T/H
 H: SMT
 Different key code: 1,2 (T/H)
 1,2,3,4 (SMT)

JAE will supply the complete mating harness designed to customer specifications.

Contact JAE | JAE Global Subsidiaries

Connector Sales

USA - Commercial

JAE Electronics, Inc.
142 Technology Dr. #100
Irvine, CA 92618
Email: jaeinfo@jae.com
Tel +1 949-753-2600
Fax +1 949-753-2699
www.jaeusa.com

USA - Automotive

JAE Electronics, Inc. (Automotive)
19500 Victor Parkway #275
Livonia, MI 48152
Email: shinskew@jae.com
Tel +1 734-542-0486 x702
Fax +1 734-542-0495
www.jaeusa.com

Europe

JAE Europe, Ltd.
200 Fowler Avenue
Farnborough Business Park
Farnborough Hampshire, GU14 7JP, U.K.
Email: sales@jae.co.uk
Tel +44 1252 55 11 22
Fax +44 1252 55 11 10
www.jae-europe.com

Hong Kong

JAE Hong Kong, Ltd.
1407-11, 14/F, Tower 2
The Gateway, 25 Canton Road,
Tsimshatsui, Kowloon, Hong Kong
Email: info@jae.com.hk
Tel +852-2723-7782
Fax +852-2723-9028

Japan

Japan Aviation Electronics Industry, Ltd.
1st International Operations Div.
1-19, Aobodai 3-chome, Meguro-ku
Tokyo 153-8539, Japan
E-mail iodinfo@jae.co.jp
Tel +81-3-3780-2768
Fax +81-3-3780-2883
www.jae.com

Korea

JAE Korea, Inc.
13F, Namgang B/D, 291,
Gangnamde-ro, Seocho-gu,
Seoul, 137-861, Korea
Email: info@kr.jae.co.jp
Tel +82-2-6230-1100
Fax +82-2-6230-1190

Shanghai

JAE Shanghai Co., Ltd.
8F, Jin Hong Qiao Business Building, No. 8, 555
Gubei Rd, Chang Ning District,
Shanghai, 200051 P.R. China
Email: info.sh@jae.com.cn
Tel +86-21-6236-0322
Fax +86-21-6236-1292

Singapore

JAE Singapore Pte Ltd.
33 Tannery Lane, #02-01 Hoesteel
Industrial Building, Singapore 347789
Email: info@jae.com.sg
Tel +65-6748-1332
Fax +65-6748-2920

Taiwan

JAE Taiwan, Ltd.
No. 35, 20th Rd., Industrial Park
Taichung, 40850, Taiwan
Email: coninfo@jae.com.tw
Tel +886-4-2359-3411
Fax +886-4-2359-3697
www.jae.com.tw

View JAE's Global Network at www.jae.com

Contact our Distributors

JAE U.S. Distributors



Digi-Key Corporation

701 Brooks Avenue South
Thief River Falls, MN 56701
Toll Free: 1-800-344-4539
Tel +1 218-681-6674
Fax +1 218-681-3380
Email: sales@digkey.com
www.digikey.com

HEILIND

Performance. Trust. Innovation.

Heilind

Wilmington, MA
Toll Free: 1-800-400-7041
Fax 1-978-658-0278
www.heilind.com



Allied Electronics, Inc.

7151 Jack Newell Blvd. S.
Fort Worth, TX 76118
Toll Free: 1-866-433-5722
www.alliedelec.com



Mouser Electronics

1000 North Main Street
Mansfield, TX 76063
Toll Free: 1-800-346-6873
Fax 817-804-3899
Email: sales@digkey.com
www.mouser.com



Kensington Electronics, Inc.

11801 Stonehollow Drive. #150
Austin, TX 78758
Toll Free: 1-800-325-0534
Fax: 512-833-8034
www.keiconn.com

JAE Distribution Manager

Kevin Mearkle
Office: (814) 784-3934
Email: mearkle@jae.com

Visit us online at www.jae.com to check distributor stock

JAE Global Network

📍 Headquarters 📍 Sales & Support 📍 Development & Manufacturing 📍 Manufacturing 📍 Other



JAE Electronics, Inc.

142 Technology Drive, Suite 100
Irvine, CA 92618
Telephone: +1 (949) 753-2600 | Fax: +1 (949) 753-2699
www.jae.com

*No part of this publication may be reproduced or distributed in any means, or stored in a data based or retrieval system, without the prior written permission of JAE Electronics, Inc.

Copyright © 2018 JAE Electronics, Inc.

Technology to Inspire Innovation

